

# Rølde U-Vorm | Colli 1

.....

## Rølde U-Shape | Colli 1

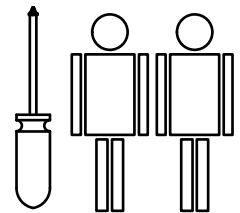
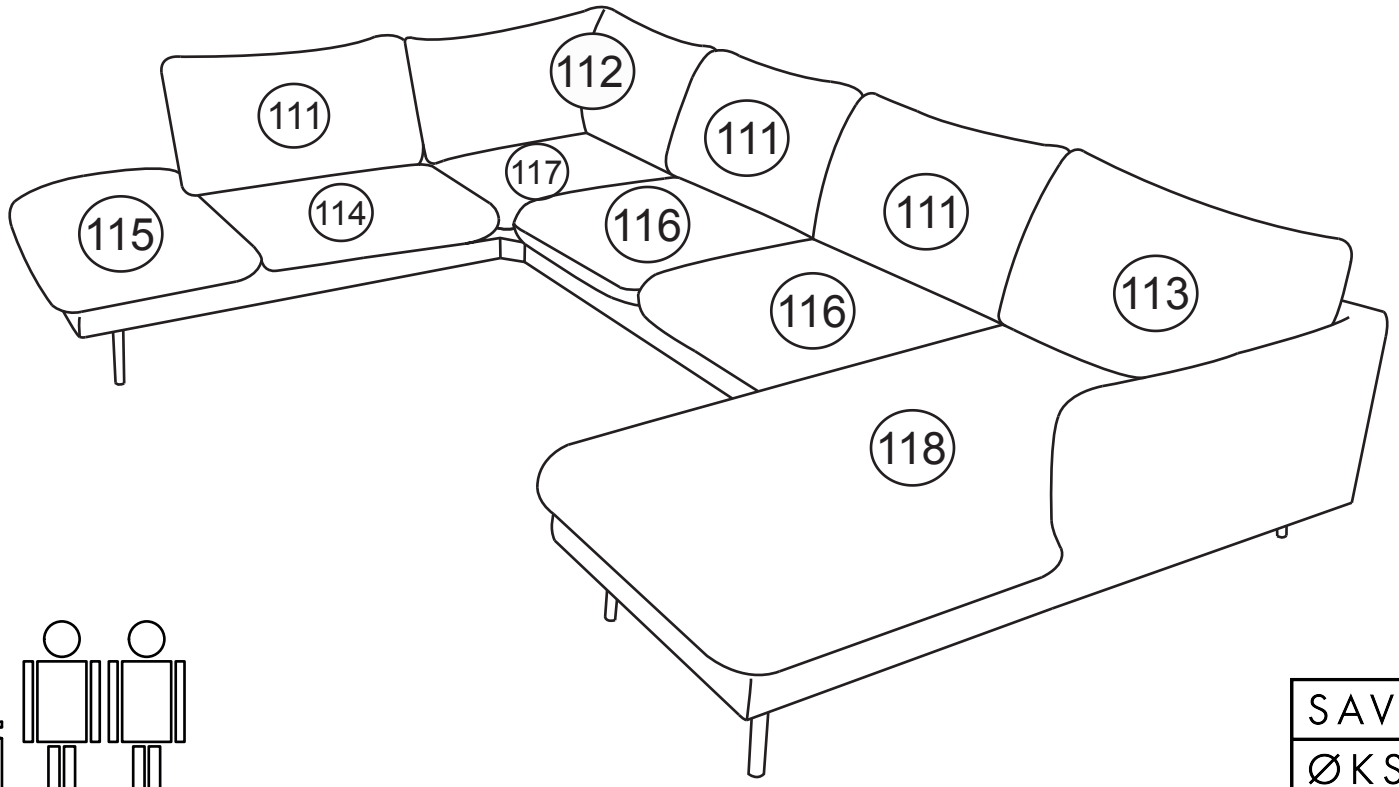
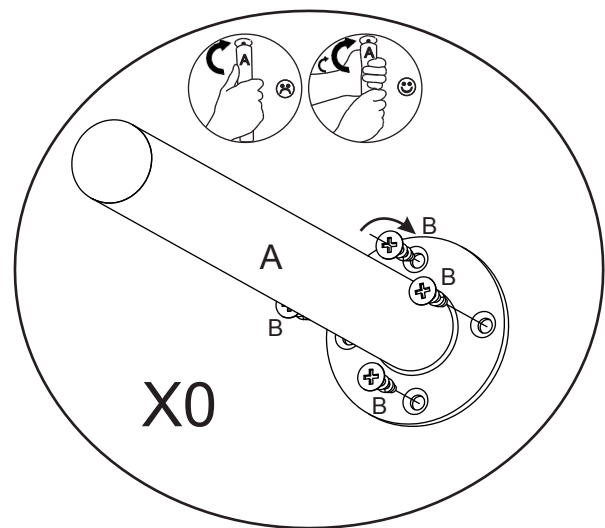
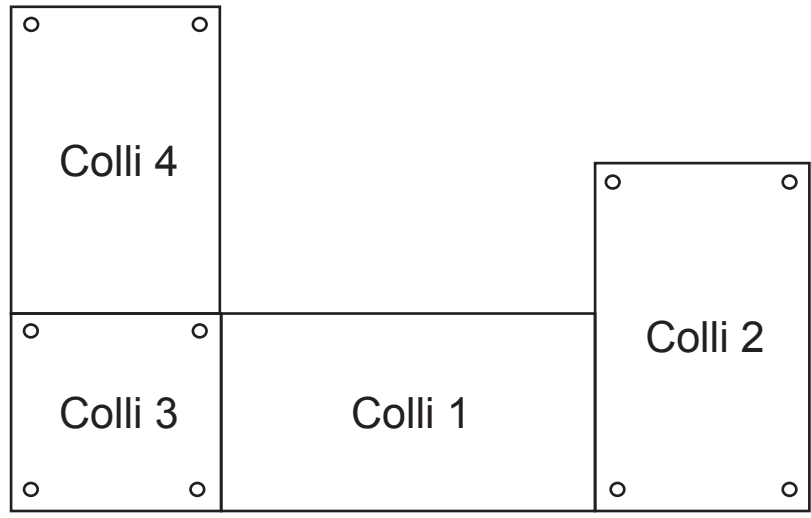

A

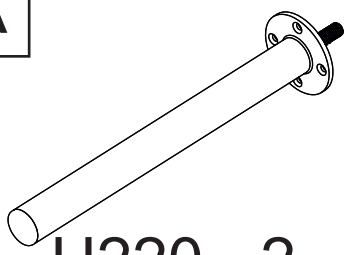

H220 - 2

B

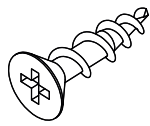

4x16 - 8

# Rølde U-Vorm | Colli 4

Rølde U-Shape | Colli 4

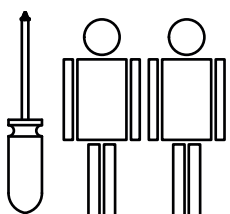
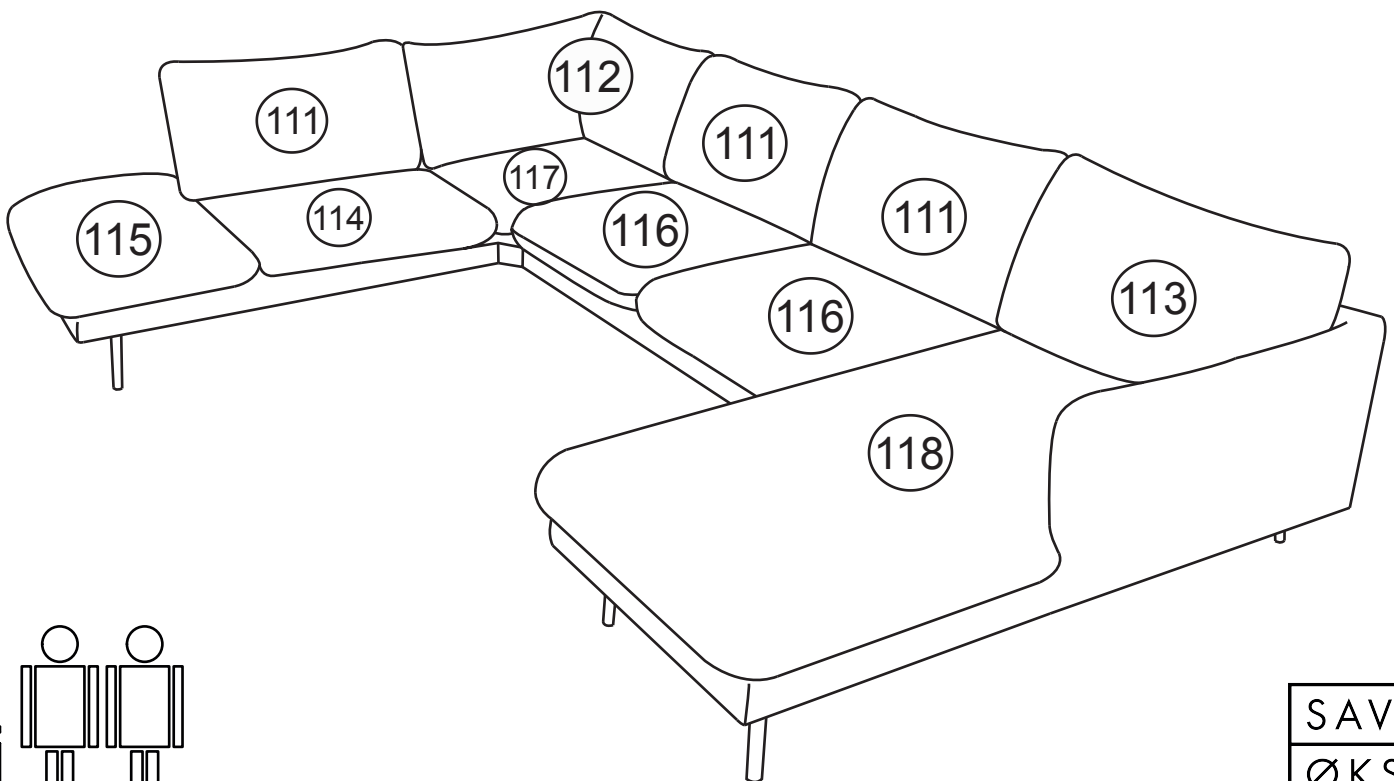
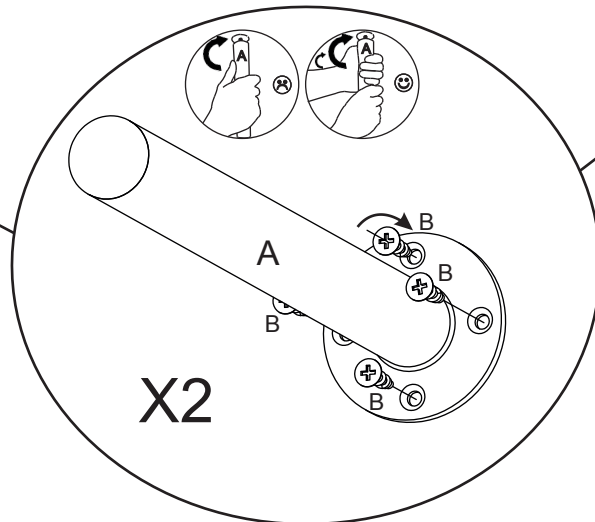
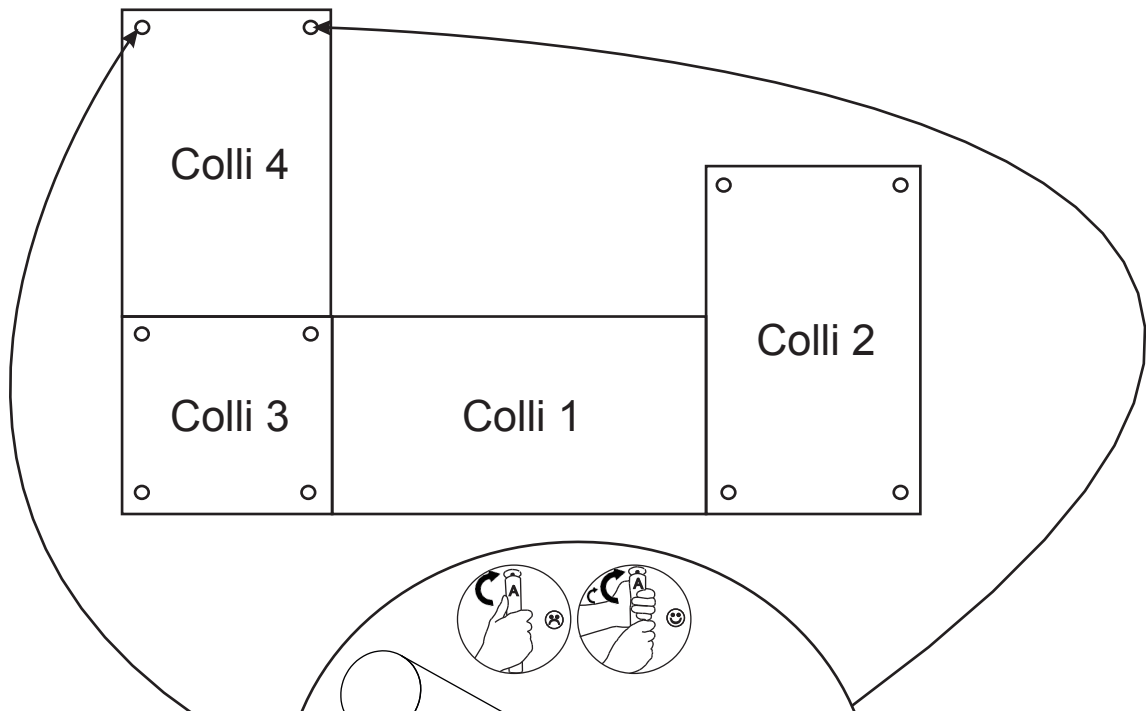

SAV	&
ØKSE	

A

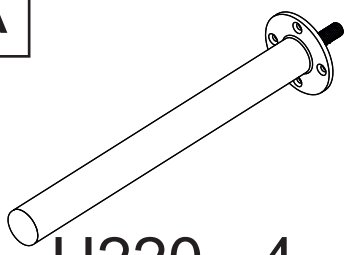

H220 - 4

B

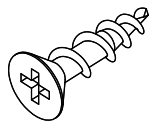

4x16 - 16

# Rølde U-Vorm | Colli 3

Rølde U-Shape | Colli 3

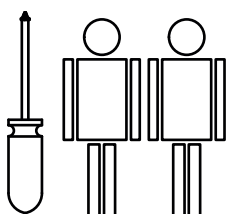
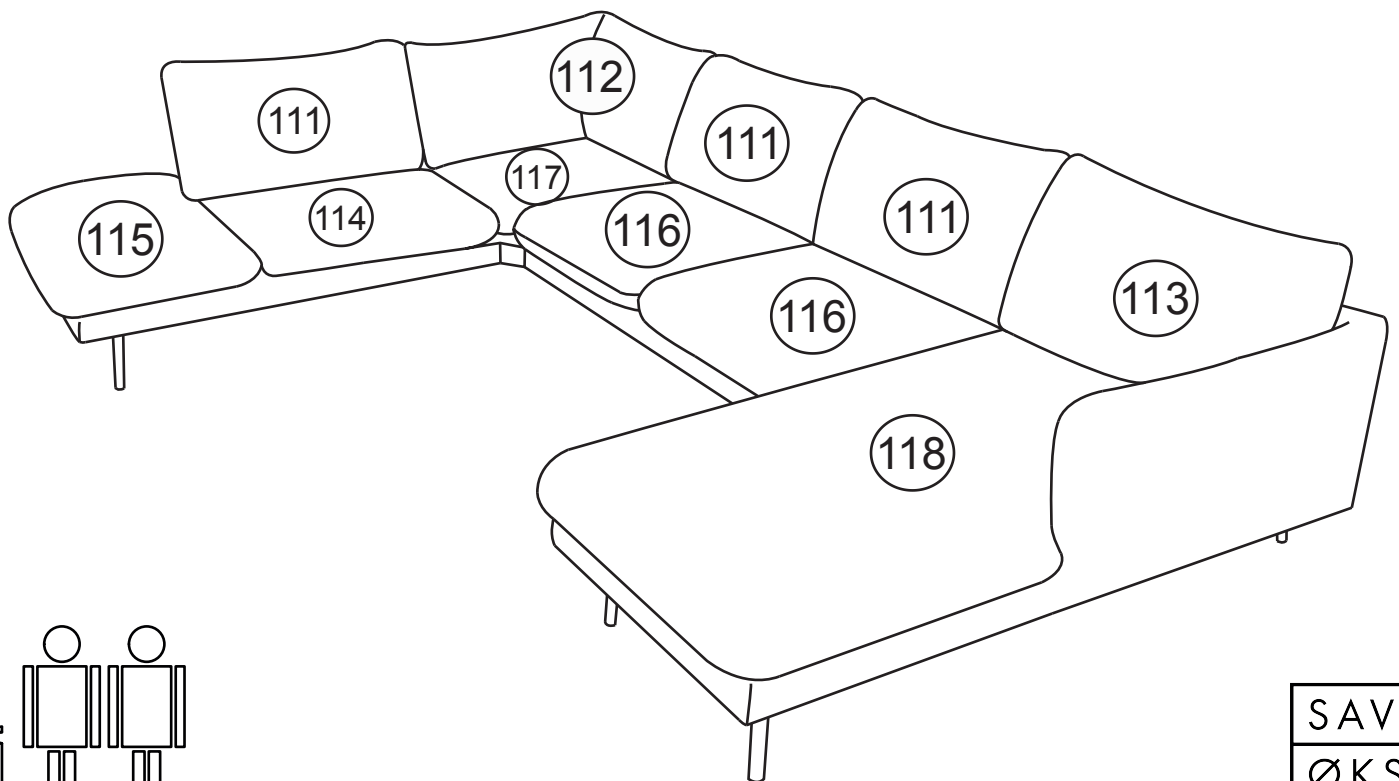
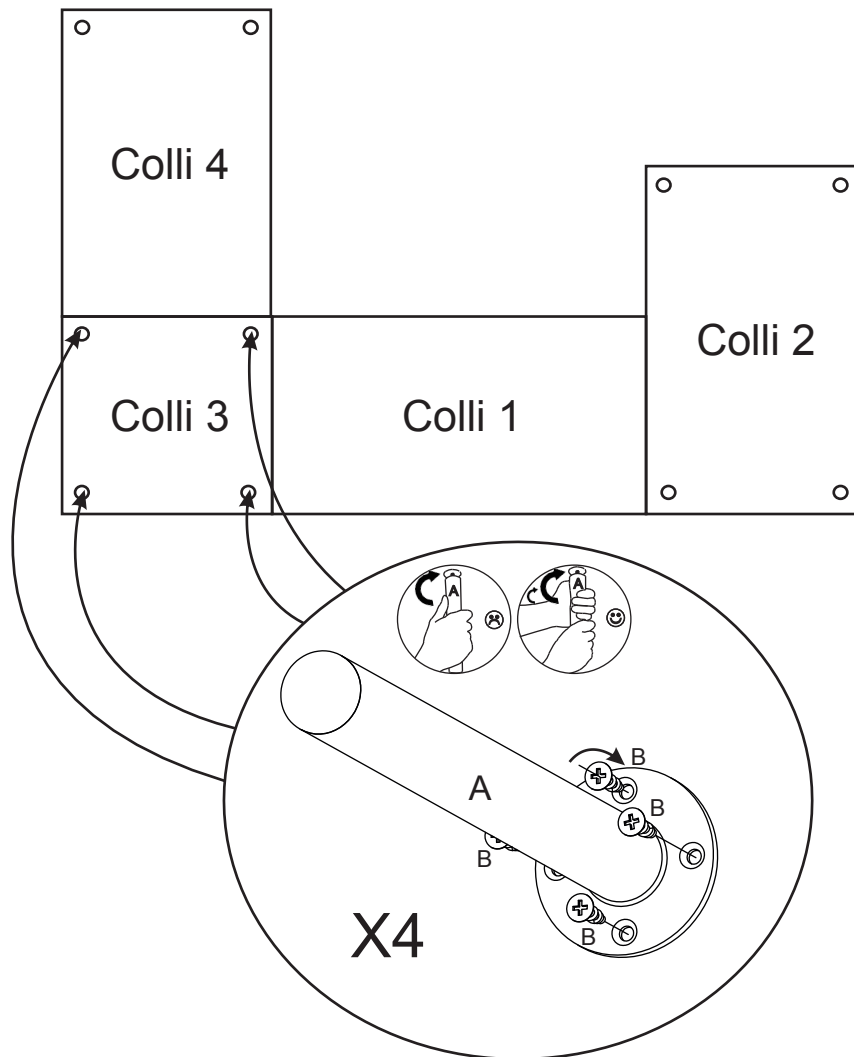

SAV	&
ØKSE	

A

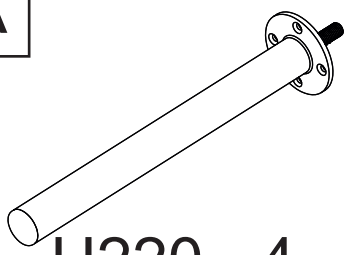

H220 - 4

B

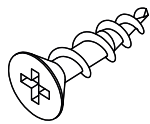

4x16 - 16

# Rølde U-Vorm | Colli 2

Rølde U-Shape | Colli 2

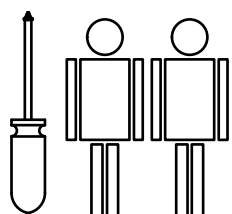
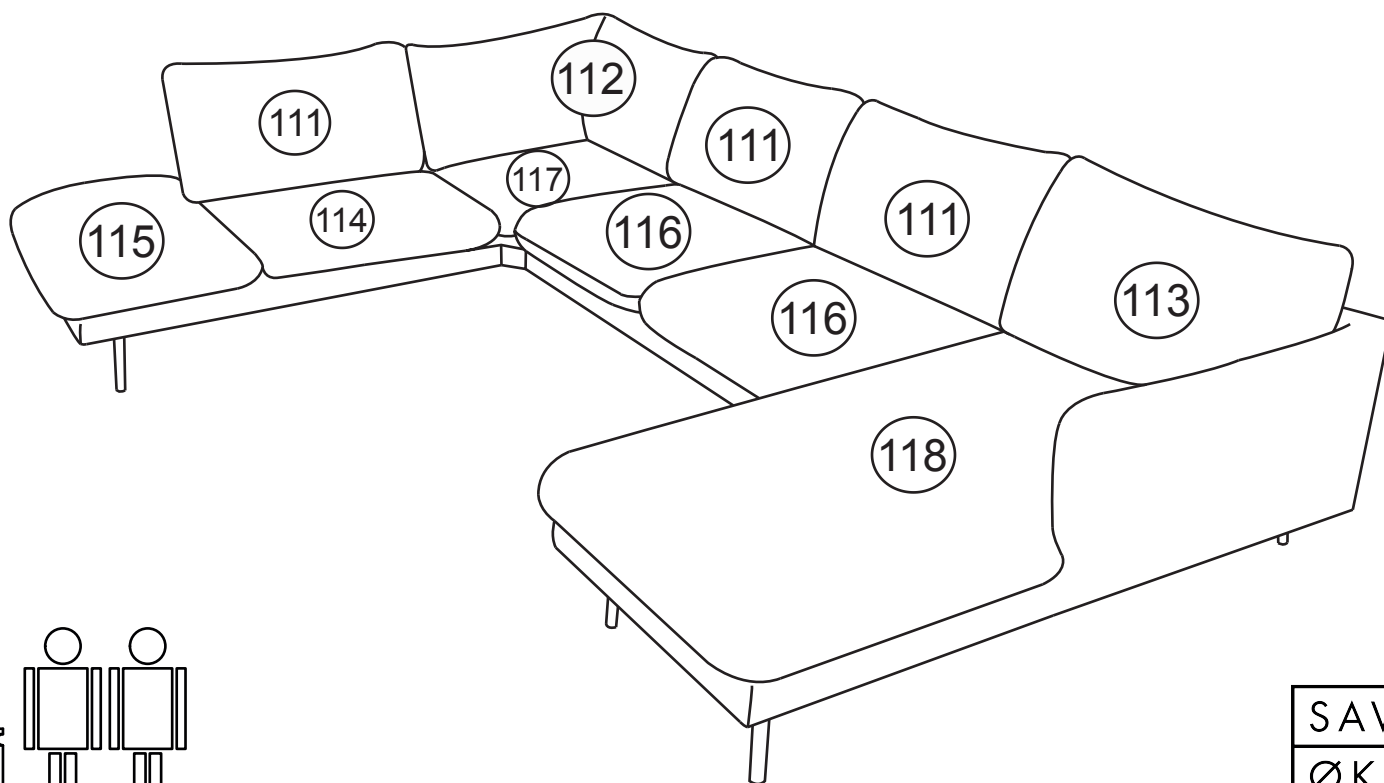
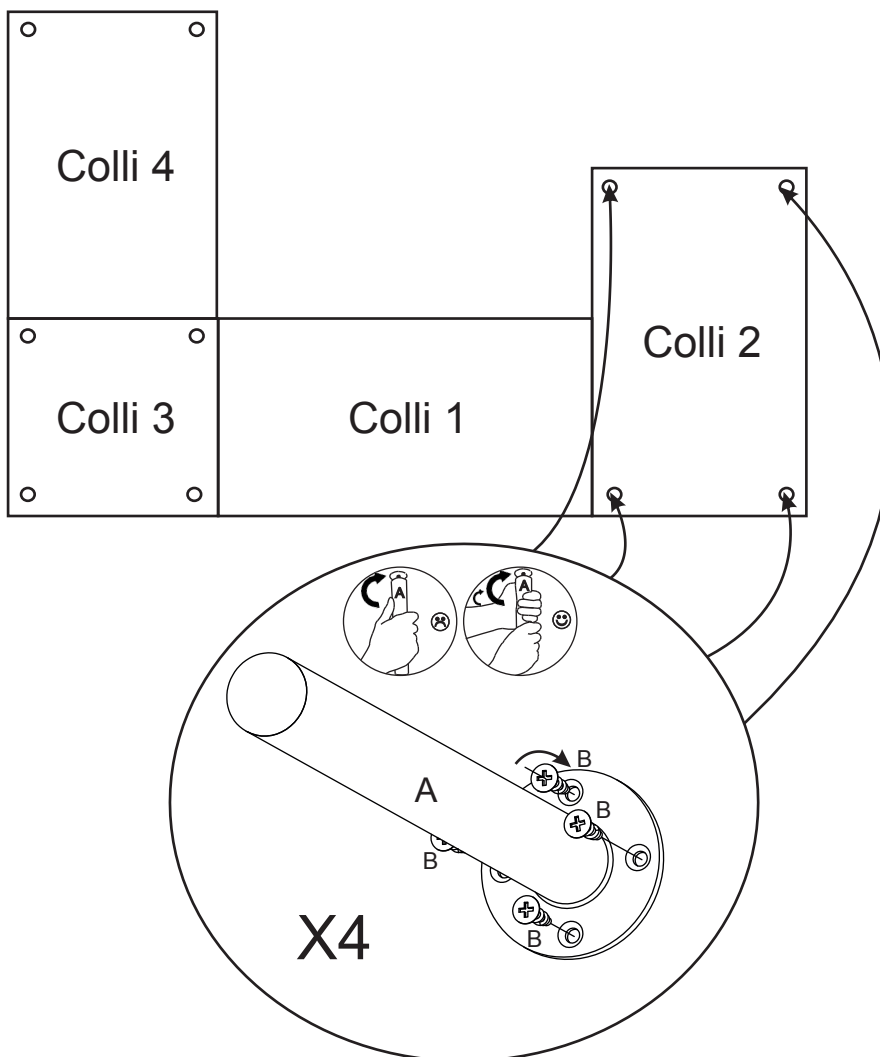

SAV	&
ØKSE	