

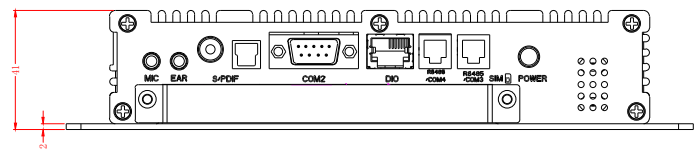

| No. | Rev. | Revision Record | Date |
|-----|------|-----------------|------|
| △ | | | |
| | | | |
| | | | |

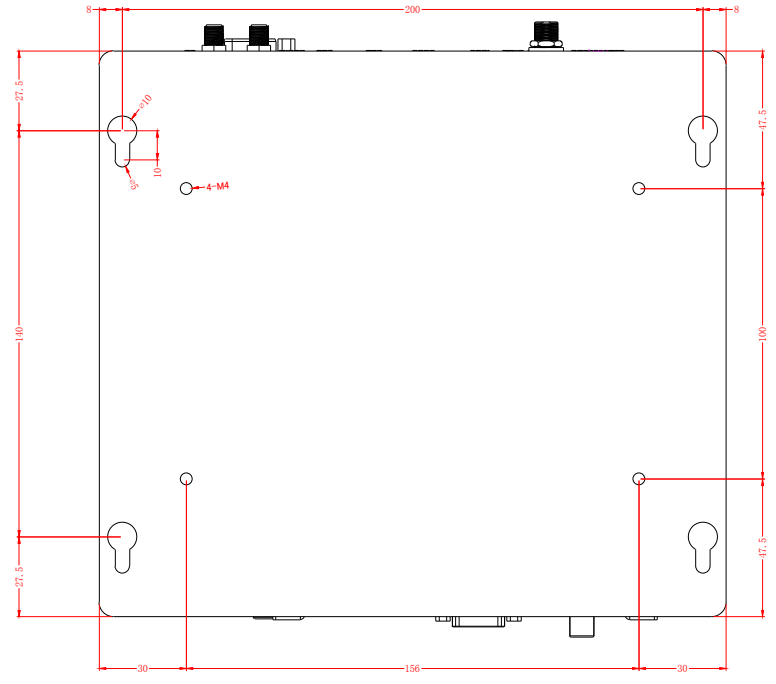
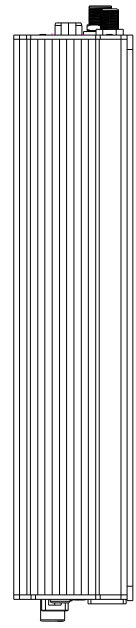
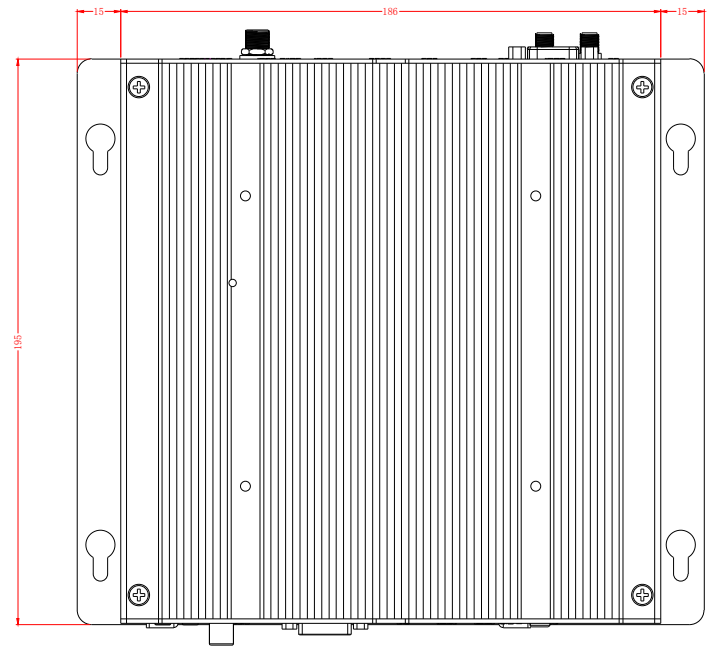
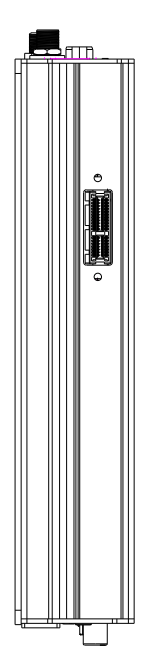
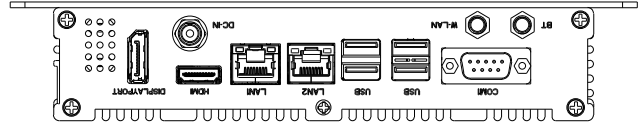

| | | | | | |
|----------------------------------|-------------|--|---------|----------|------------|
| General Tolerance ISO 2768-1c | ISO 2768-1c |  深圳市飞帆泰科技有限公司 SHENZHEN FEIFANTAI TECHNOLOGY CO., LTD | | | |
| UNIT | mm | Description | | 无屏阿波罗IPC | |
| Scale | 1:1 | Designed | Dongmei | Date | 2018-11-13 |
| REV. | A0 | Checked | | Date | |
| | | Approved | | Date | |

Autodesk

Autodesk