

# 4 RAILING PRODUCTEN

2021 - 2022



# **4 RAILING PRODUCTEN**

2021 - 2022

# KIEZEN VOOR 4RAILING IS KIEZEN VOOR KWALITEIT

**Op zoek naar een passende oplossing, snelle levering en een correcte service? De specialisten van 4Railing denken graag met u mee!**

**4Railing** biedt een ruim assortiment railingsystemen. Maak zelf de gewenste combinatie, onze producten zijn modulair en passen altijd. Onze producten zijn ontworpen voor eenvoudige montage en verkrijgbaar in meerdere uitvoeringen.

**4Railing** levert kwaliteitsproducten voor uw project: geen verschillen in oppervlakte en kleur. Exacte maatvoering en geen ongewenste toleranties.

**4Railing** laat alle producten uitvoerig testen. Goed om te weten... voor uw veiligheid.

**4Railing** levert maatwerk. Graag uw railing in een specifieke RAL kleur? Dat kan! Geef de gewenste kleur door bij uw bestelling en wij regelen het voor u.

Op **[www.4railing.com](http://www.4railing.com)** vindt u een overzicht van onze producten. Bestellen is heel eenvoudig. Komt u er toch niet helemaal uit? Dan zijn onze specialisten eenvoudig bereikbaar per telefoon, zij helpen u graag. Alle producten die op voorraad zijn worden dezelfde dag nog verstuurd.

Vindt u niet wat u zoekt? Neem gerust contact met ons op en daag onze specialisten uit. We leveren ook maatwerk als dat nodig is. Profiteer van onze kennis en ruime ervaring.

U bent van harte welkom!

**Team 4Railing**

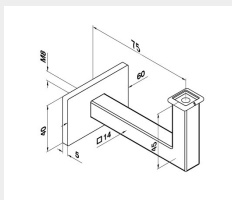
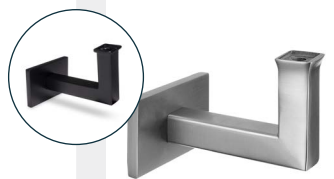

MODEL	□			€
<b>15.4117.000.15</b>	flat / L: 75 mm	AISI 304 Satin	2	16,10 p/s
<b>15.4117.000.16</b>	flat / L: 75 mm	AISI 316 Satin	2	21,00 p/s
<b>15.4117.000.17</b>	flat / L: 75 mm	AISI 9005 mat zwart	2	24,10 p/s
<b>15.4117.000.18</b>	flat / L: 75 mm	AISI 9005 zwart fijnstructuur	2	24,10 p/s

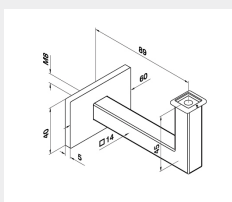
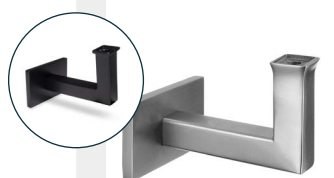

MODEL	□			€
<b>15.4111.000.15</b>	flat / L: 89 mm	AISI 304 Satin	2	16,10 p/s
<b>15.4111.000.16</b>	flat / L: 89 mm	AISI 316 Satin	2	21,00 p/s
<b>15.4111.000.17</b>	flat / L: 89 mm	AISI 9005 mat zwart	2	24,10 p/s
<b>15.4111.000.18</b>	flat / L: 89 mm	AISI 9005 zwart fijnstructuur	2	24,10 p/s

4

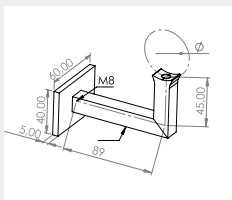
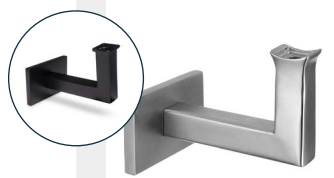

MODEL	∅			€
<b>15.4111.042.15</b>	42,4 mm	AISI 304 Satin	2	16,10 p/s
<b>15.4111.042.17</b>	42,4 mm	AISI 9005 mat zwart	2	24,10 p/s
<b>15.4111.042.18</b>	42,4 mm	AISI 9005 zwart fijnstructuur	2	24,10 p/s



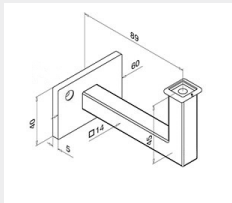
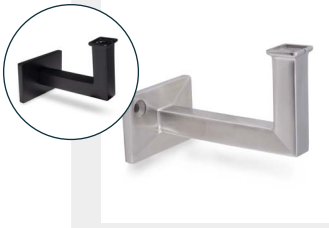

MODEL	□			€
<b>15.4112.000.15</b>	flat / L: 89 mm	AISI 304 Satin	2	16,10 p/s
<b>15.4112.000.17</b>	flat / L: 89 mm	AISI 9005 mat zwart	2	24,10 p/s
<b>15.4112.000.18</b>	flat / L: 89 mm	AISI 9005 zwart fijnstructuur	2	24,10 p/s

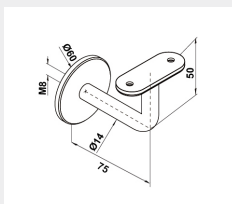

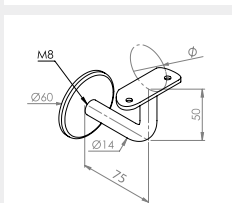

MODEL	□			€
<b>15.0111.000.15</b>	flat	AISI 304 RVS	2	10,20 p/s
<b>15.0111.000.16</b>	flat	AISI 316 Satin	2	14,65 p/s
<b>15.0111.000.17</b>	flat	AISI 9005 mat zwart	2	18,20 p/s
<b>15.0111.000.18</b>	flat	AISI 9005 zwart fijnstructuur	2	18,20 p/s

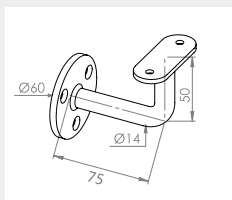

MODEL	∅			€
<b>15.0111.042.15</b>	42,4 mm	AISI 304 RVS	2	10,20 p/s
<b>15.0111.042.16</b>	42,4 mm	AISI 316 Satin	2	14,65 p/s
<b>15.0111.042.17</b>	42,4 mm	AISI 9005 mat zwart	2	18,20 p/s
<b>15.0111.042.18</b>	42,4 mm	AISI 9005 zwart fijnstructuur	2	18,20 p/s
<b>15.0111.033.15</b>	33,7 mm	AISI 304 RVS	2	10,20 p/s
<b>15.0111.033.17</b>	33,7 mm	AISI 9005 mat zwart	2	18,20 p/s
<b>15.0111.033.18</b>	33,7 mm	AISI 9005 zwart fijnstructuur	2	18,20 p/s



MODEL	□			€
<b>15.0100.000.15</b>	flat	AISI 304 Satin	2	10,20 p/s
<b>15.0100.000.16</b>	flat	AISI 316 Satin	2	14,65 p/s
<b>15.0100.000.17</b>	flat	AISI 9005 mat zwart	2	18,20 p/s
<b>15.0100.000.18</b>	flat	AISI 9005 zwart fijnstructuur	2	18,20 p/s

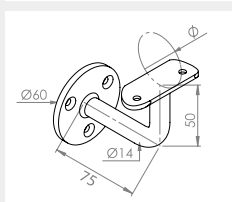

MODEL	∅			€
<b>15.0100.042.15</b>	42,4 mm	AISI 304 Satin	2	10,20 p/s
<b>15.0100.042.16</b>	42,4 mm	AISI 316 Satin	2	14,65 p/s
<b>15.0100.042.17</b>	42,4 mm	AISI 9005 mat zwart	2	18,20 p/s
<b>15.0100.042.18</b>	42,4 mm	AISI 9005 zwart fijnstructuur	2	18,20 p/s
<b>15.0100.033.15</b>	33,7 mm	AISI 304 Satin	2	10,20 p/s
<b>15.0100.033.17</b>	33,7 mm	AISI 9005 mat zwart	2	18,20 p/s
<b>15.0100.033.18</b>	33,7 mm	AISI 9005 zwart fijnstructuur	2	18,20 p/s

6



**UITGEBREID  
ASSORTIMENT**

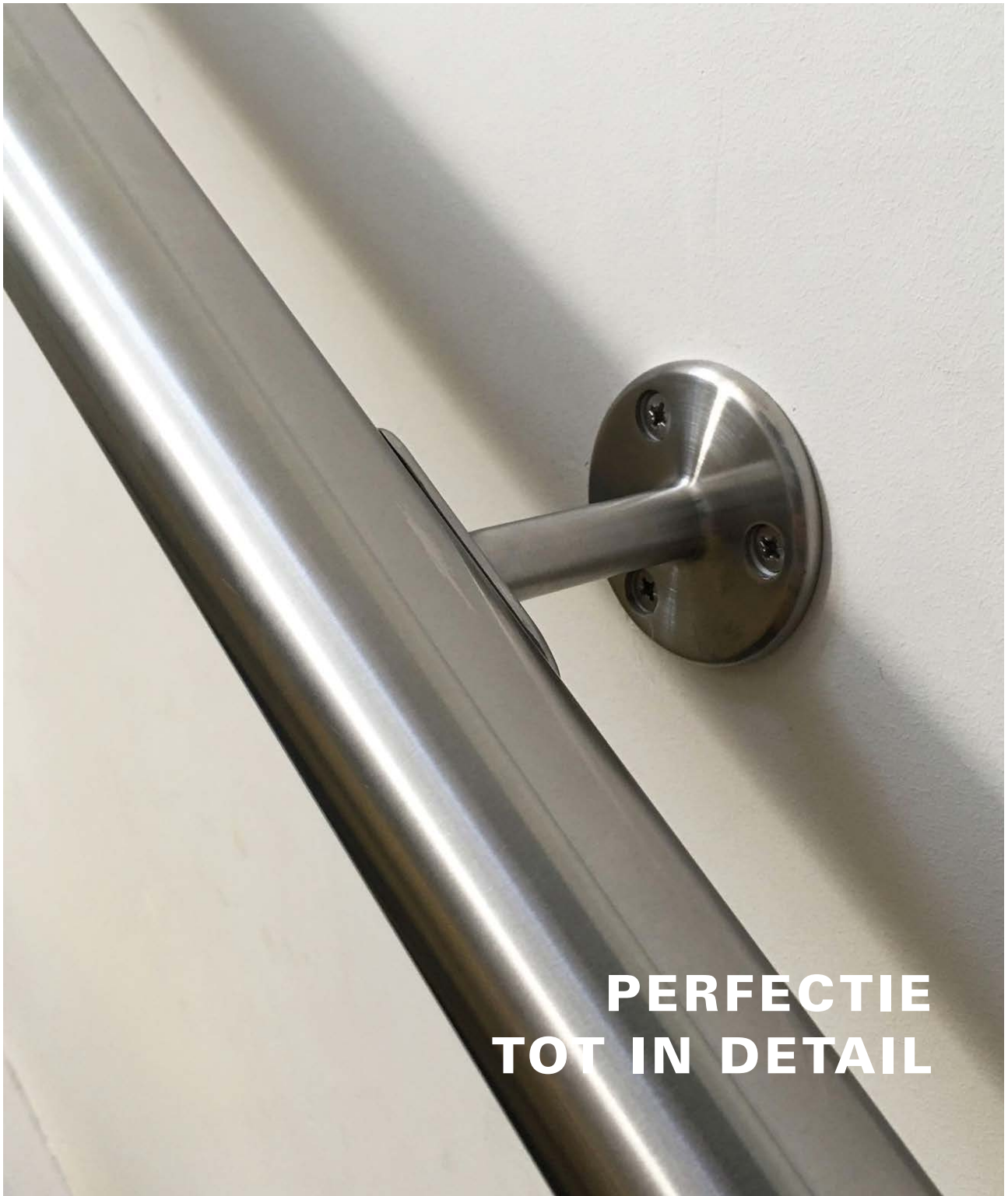

**PERFECTIE  
TOT IN DETAIL**



MODEL	Ø			€
<b>15.0708.042.15</b>	42,4 mm	AISI 304 Satin	2	9,45 p/s
<b>15.0708.042.16</b>	42,4 mm	AISI 316 Satin	2	12,40 p/s
<b>15.0708.042.17</b>	42,4 mm	AISI 9005 mat zwart	2	17,45 p/s
<b>15.0708.042.18</b>	42,4 mm	AISI 9005 zwart fijnstructuur	2	17,45 p/s
<b>15.0708.048.15</b>	48,3 mm	AISI 304 Satin	2	9,45 p/s
<b>15.0708.048.17</b>	48,3 mm	AISI 9005 mat zwart	2	17,45 p/s
<b>15.0708.048.18</b>	48,3 mm	AISI 9005 zwart fijnstructuur	2	17,45 p/s

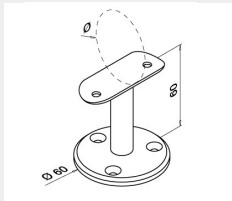

MODEL	□			€
<b>15.0708.000.15</b>	flat	AISI 304 Satin	2	9,50 p/s
<b>15.0708.000.17</b>	flat	AISI 9005 mat zwart	2	17,50 p/s
<b>15.0708.000.18</b>	flat	AISI 9005 zwart fijnstructuur	2	17,50 p/s

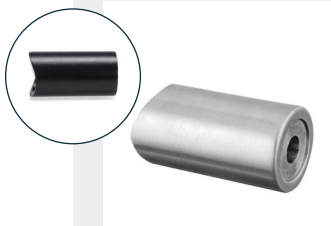
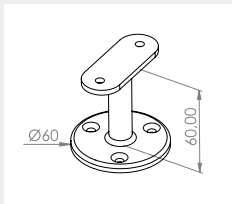

MODEL	Ø			€
<b>15.0625.042.15</b>	42,4 mm x 25 mm	AISI 304 Satin	4	7,05 p/s
<b>15.0625.042.16</b>	42,4 mm x 25 mm	AISI 316 Satin	4	9,65 p/s
<b>15.0625.042.17</b>	42,4 mm x 25 mm	AISI 9005 mat zwart	4	14,05 p/s
<b>15.0625.042.18</b>	42,4 mm x 25 mm	AISI 9005 zwart fijnstructuur	4	14,05 p/s
<b>15.0625.033.15</b>	33,7 mm x 25 mm	AISI 304 Satin	4	7,05 p/s
<b>15.0625.033.17</b>	33,7 mm x 25 mm	AISI 9005 mat zwart	4	15,05 p/s
<b>15.0625.033.18</b>	33,7 mm x 25 mm	AISI 9005 zwart fijnstructuur	4	15,05 p/s

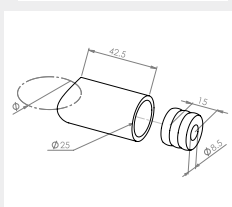

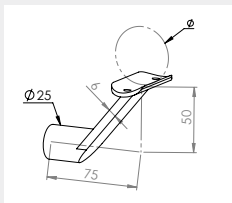

MODEL	∅			€
<b>15.0123.042.15</b>	42,4 mm	AISI 304 Satin	2	12,35 p/s
<b>15.0123.042.17</b>	42,4 mm	AISI 9005 mat zwart	2	20,35 p/s
<b>15.0123.042.18</b>	42,4 mm	AISI 9005 zwart fijnstructuur	2	20,35 p/s

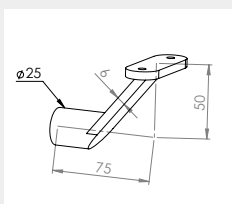

MODEL	□			€
<b>15.0123.000.15</b>	flat	AISI 304 Satin	2	12,35 p/s
<b>15.0123.000.17</b>	flat	AISI 9005 mat zwart	2	20,35 p/s
<b>15.0123.000.18</b>	flat	AISI 9005 zwart fijnstructuur	2	20,35 p/s

10

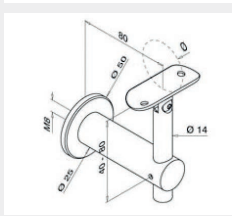

MODEL	∅			€
<b>15.0144.042.15</b>	42,4 mm	AISI 304 Satin	2	17,30 p/s
<b>15.0144.042.16</b>	42,4 mm	AISI 316 Satin	2	22,45 p/s
<b>15.0144.048.15</b>	48,3 mm	AISI 304 Satin	2	17,30 p/s

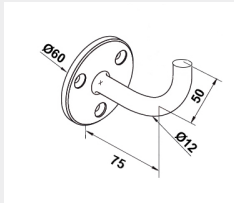

MODEL	Ø			€
<b>15.0113.000.15</b>	12 mm	AISI 304 Satin	2	8,05 p/s

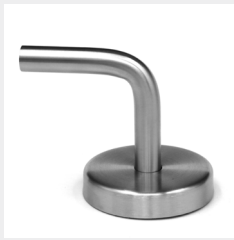

MODEL	Ø			€
<b>15.0115.000.15</b>	12 mm	AISI 304 Satin	2	11,55 p/s

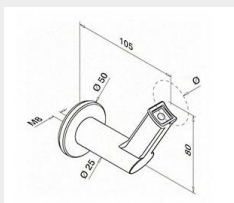

MODEL	Ø			€
<b>15.9320.042.15</b>	42,4 mm	AISI 304 Satin	2	24,55 p/s
<b>15.9320.042.17</b>	42,4 mm	AISI 9005 mat zwart	2	32,55 p/s
<b>15.9320.042.18</b>	42,4 mm	AISI 9005 zwart fijnstructuur	2	32,55 p/s



12



**FUNCTIONEEL  
MAATWERK**



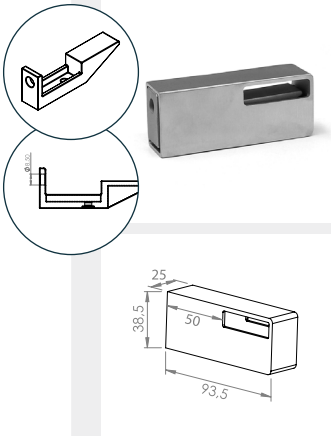

MODEL	□	🌀	📦	€
<b>15.4134.041.15</b>	40 x 10 x 1,5 mm	AISI 304 RVS	2	19,05 p/s
<b>15.4134.041.16</b>	40 x 10 x 1,5 mm	AISI 316 RVS	2	24,80 p/s

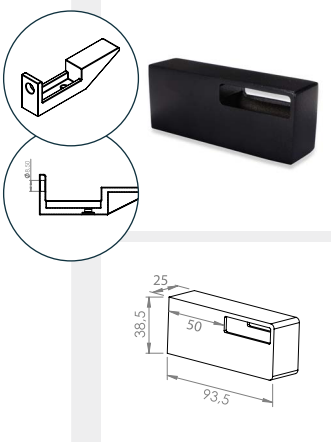

MODEL	□	🌀	📦	€
<b>15.4134.041.17</b>	40 x 10 x 1,5 mm	AISI 9005 mat zwart	2	27,05 p/s
<b>15.4134.041.18</b>	40 x 10 x 1,5 mm	AISI 9005 zwart fijnstructuur	2	27,05 p/s

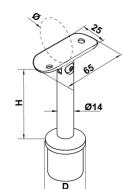

MODEL	Ø			€
<b>15.0718.242.15</b>	42,4 mm x D 42,4 x 2,0 mm	AISI 304 Satin	2	12,75 p/s
<b>15.0718.242.16</b>	42,4 mm x D 42,4 x 2,0 mm	AISI 316 Satin	2	14,90 p/s
<b>15.0718.042.15</b>	42,4 mm x D 42,4 x 2,6 mm	AISI 304 Satin	2	12,75 p/s
<b>15.0718.042.16</b>	42,4 mm x D 42,4 x 2,6 mm	AISI 316 Satin	2	15,80 p/s
<b>15.0719.248.15</b>	48,3 mm x D 48,3 x 2,0 mm	AISI 304 Satin	2	12,75 p/s
<b>15.0719.248.16</b>	48,3 mm x D 48,3 x 2,0 mm	AISI 316 Satin	2	15,80 p/s

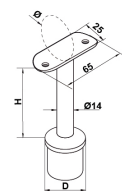

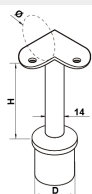

MODEL	Ø			€
<b>15.0710.242.15</b>	42,4 mm x D 42,4 x 2,0 mm	AISI 304 Satin	2	11,75 p/s
<b>15.0710.242.16</b>	42,4 mm x D 42,4 x 2,0 mm	AISI 316 Satin	2	14,80 p/s
<b>15.0710.042.15</b>	42,4 mm x D 42,4 x 2,6 mm	AISI 304 Satin	2	11,75 p/s
<b>15.0718.242.16</b>	42,4 mm x D 42,4 x 2,6 mm	AISI 316 Satin	2	14,80 p/s
<b>15.0711.248.15</b>	48,3 mm x D 48,3 x 2,0 mm	AISI 304 Satin	2	11,75 p/s
<b>15.0711.248.16</b>	48,3 mm x D 48,3 x 2,0 mm	AISI 316 Satin	2	14,80 p/s

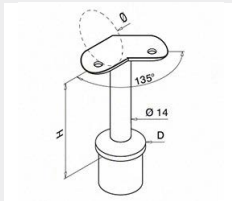

MODEL	Ø			€
<b>15.0710.242.15</b>	42,4 mm x D 42,4 x 2,0 mm	AISI 304 Satin	2	12,75 p/s
<b>15.0710.242.16</b>	42,4 mm x D 42,4 x 2,0 mm	AISI 316 Satin	2	15,80 p/s
<b>15.0710.942.15</b>	42,4 mm x D 42,4 x 2,6 mm	AISI 304 Satin	2	12,75 p/s
<b>15.0710.942.16</b>	42,4 mm x D 42,4 x 2,6 mm	AISI 316 Satin	2	15,80 p/s
<b>15.0711.848.15</b>	48,3 mm x D 48,3 x 2,0 mm	AISI 304 Satin	2	12,75 p/s
<b>15.0711.848.16</b>	48,3 mm x D 48,3 x 2,0 mm	AISI 316 Satin	2	15,80 p/s



MODEL	Ø			€
<b>13.0710.342.15</b>	42,4 mm x D 42,4 x 2,0 mm	AISI 304 Satin	2	12,75 p/s
<b>13.0710.342.16</b>	42,4 mm x D 42,4 x 2,0 mm	AISI 316 Satin	2	15,80 p/s
<b>13.0710.442.15</b>	42,4 mm x D 42,4 x 2,6 mm	AISI 304 Satin	2	12,75 p/s
<b>13.0710.442.16</b>	42,4 mm x D 42,4 x 2,6 mm	AISI 316 Satin	2	15,80 p/s
<b>13.0711.348.15</b>	48,3 mm x D 48,3 x 2,0 mm	AISI 304 Satin	2	12,75 p/s
<b>13.0711.348.16</b>	48,3 mm x D 48,3 x 2,0 mm	AISI 316 Satin	2	15,80 p/s



High quality Glue  
50 ml.  
**15.0000.000.15**



**VAN KLASSIEK  
TOT MODERN**

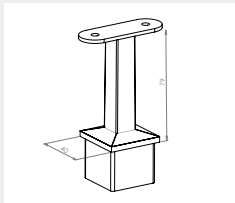

MODEL	<input type="checkbox"/>			€
<b>15.4710.000.15</b>	40 x 40 x 2 x flat	AISI 304 Satin	2	15,95 p/s
<b>15.4710.000.16</b>	40 x 40 x 2 x flat	AISI 316 Satin	2	20,80 p/s

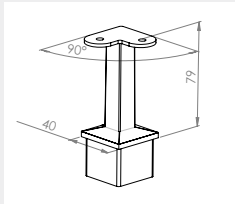

MODEL	<input type="checkbox"/>			€
<b>15.4710.800.15</b>	40 x 40 x 2 x flat	AISI 304 Satin	2	15,95 p/s
<b>15.4710.800.16</b>	40 x 40 x 2 x flat	AISI 316 Satin	2	20,80 p/s

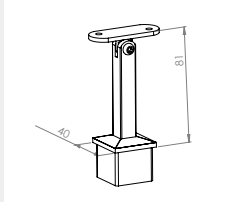

MODEL	<input type="checkbox"/>			€
<b>15.4718.000.15</b>	40 x 40 x 2 x flat	AISI 304 Satin	2	15,95 p/s
<b>15.4718.000.16</b>	40 x 40 x 2 x flat	AISI 316 Satin	2	20,80 p/s

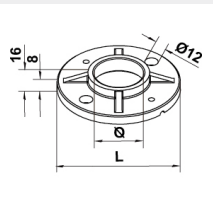

MODEL	Ø			€
<b>15.0940.042.15</b>	42,4 mm x L 100	AISI 304 Satin	2	9,85 p/s
<b>15.0940.042.16</b>	42,4 mm x L 100	AISI 316 Satin	2	13,20 p/s
<b>15.0940.048.15</b>	48,3 mm x L 100	AISI 304 Satin	2	9,85 p/s
<b>15.0940.048.16</b>	48,3 mm x L 100	AISI 316 Satin	2	13,20 p/s

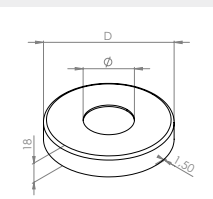

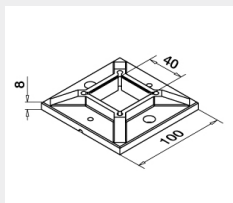

MODEL	Ø			€
<b>15.0512.042.15</b>	42,4 mm x D 105 mm	AISI 304 Satin	2	6,40 p/s
<b>15.0512.042.16</b>	42,4 mm x D 105 mm	AISI 316 Satin	2	8,05 p/s
<b>15.0512.048.15</b>	48,3 mm x D 105 mm	AISI 304 Satin	2	6,40 p/s
<b>15.0512.048.16</b>	48,4 mm x D 105 mm	AISI 316 Satin	2	8,05 p/s

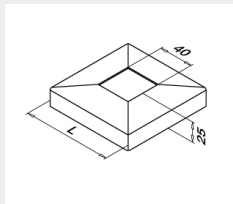

MODEL	□			€
<b>15.4940.040.15</b>	40 x 40 mm x L 100 mm	AISI 304 Satin	2	23,80 p/s
<b>15.4940.040.16</b>	40 x 40 mm x L 100 mm	AISI 316 Satin	2	29,95 p/s



MODEL	□			€
<b>15.0718.242.15</b>	40 x 40 mm x L 108 mm	AISI 304 Satin	2	13,85 p/s
<b>15.0718.242.16</b>	40 x 40 mm x L 108 mm	AISI 316 Satin	2	18,10 p/s

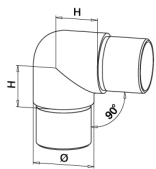

MODEL	Ø			€
<b>15.0303.242.15</b>	42,4 mm x 2,0 mm	AISI 304 Satin	2	14,65 p/s
<b>15.0303.242.16</b>	42,4 mm x 2,0 mm	AISI 316 Satin	2	18,90 p/s
<b>15.0303.042.15</b>	42,4 mm x 2,6 mm	AISI 304 Satin	2	14,65 p/s
<b>15.0303.042.16</b>	42,4 mm x 2,6 mm	AISI 316 Satin	2	18,90 p/s
<b>15.0303.048.15</b>	48,3 mm x 2,0 mm	AISI 304 Satin	2	19,30 p/s
<b>15.0303.048.16</b>	48,3 mm x 2,0 mm	AISI 316 Satin	2	25,05 p/s

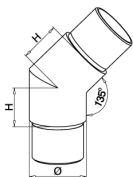

MODEL	Ø			€
<b>15.0300.242.15</b>	42,4 mm x 2,0 mm	AISI 304 Satin	2	14,65 p/s
<b>15.0300.242.16</b>	42,4 mm x 2,0 mm	AISI 316 Satin	2	18,90 p/s
<b>15.0300.042.15</b>	42,4 mm x 2,6 mm	AISI 304 Satin	2	14,65 p/s
<b>15.0300.042.16</b>	42,4 mm x 2,6 mm	AISI 316 Satin	2	18,90 p/s
<b>15.0300.048.15</b>	48,3 mm x 2,0 mm	AISI 304 Satin	2	19,30 p/s
<b>15.0300.048.16</b>	48,3 mm x 2,0 mm	AISI 316 Satin	2	25,05 p/s

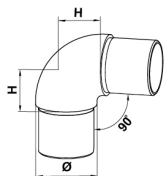

MODEL	Ø			€
<b>15.0305.242.15</b>	42,4 mm x 2,0 mm	AISI 304 Satin	2	14,65 p/s
<b>15.0305.242.16</b>	42,4 mm x 2,0 mm	AISI 316 Satin	2	18,90 p/s
<b>15.0305.042.15</b>	42,4 mm x 2,6 mm	AISI 304 Satin	2	14,65 p/s
<b>15.0305.042.16</b>	42,4 mm x 2,6 mm	AISI 316 Satin	2	18,90 p/s
<b>15.0305.048.15</b>	48,3 mm x 2,0 mm	AISI 304 Satin	2	19,30 p/s
<b>15.0305.048.16</b>	48,3 mm x 2,0 mm	AISI 316 Satin	2	25,05 p/s



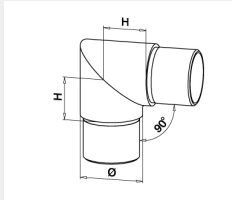

MODEL	Ø			€
<b>15.0301.242.15</b>	42,4 x 2,0 mm	AISI 304 Satin	2	14,65 p/s
<b>15.0301.242.16</b>	42,4 x 2,0 mm	AISI 316 Satin	2	18,90 p/s
<b>15.0301.042.15</b>	42,4 x 2,6 mm	AISI 304 Satin	2	14,65 p/s
<b>15.0301.042.16</b>	42,4 x 2,6 mm	AISI 316 Satin	2	18,90 p/s
<b>15.0301.048.15</b>	48,3 x 2,0 mm	AISI 304 Satin	2	19,30 p/s
<b>15.0301.048.16</b>	48,3 x 2,0 mm	AISI 316 Satin	2	25,05 p/s

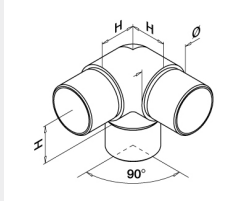

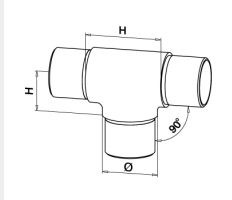

MODEL	Ø			€
<b>15.0304.242.15</b>	42,4 x 2,0 mm	AISI 304 Satin	2	17,30 p/s
<b>15.0304.242.16</b>	42,4 x 2,0 mm	AISI 316 Satin	2	22,35 p/s
<b>15.0304.042.15</b>	42,4 x 2,6 mm	AISI 304 Satin	2	17,30 p/s
<b>15.0304.042.16</b>	42,4 x 2,6 mm	AISI 316 Satin	2	22,35 p/s
<b>15.0304.048.15</b>	48,3 x 2,0 mm	AISI 304 Satin	2	22,10 p/s
<b>15.0304.048.16</b>	48,3 x 2,0 mm	AISI 316 Satin	2	28,75 p/s



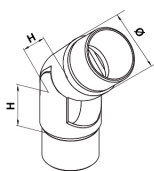

MODEL	Ø			€
<b>15.0307.242.15</b>	42,4 x 2,0 mm	AISI 304 Satin	2	17,70 p/s
<b>15.0307.242.16</b>	42,4 x 2,0 mm	AISI 316 Satin	2	23,40 p/s
<b>15.0307.042.15</b>	42,4 x 2,6 mm	AISI 304 Satin	2	17,70 p/s
<b>15.0307.042.16</b>	42,4 x 2,6 mm	AISI 316 Satin	2	23,40 p/s
<b>15.0307.048.15</b>	48,3 x 2,0 mm	AISI 304 Satin	2	25,25 p/s
<b>15.0307.048.16</b>	48,3 x 2,0 mm	AISI 316 Satin	2	32,80 p/s



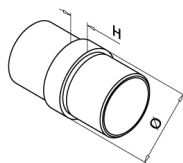

MODEL	Ø			€
<b>15.0312.242.15</b>	42,4 x 2,0 mm	AISI 304 Satin	2	24,55 p/s
<b>15.0312.242.16</b>	42,4 x 2,0 mm	AISI 316 Satin	2	31,10 p/s
<b>15.0312.042.15</b>	42,4 x 2,6 mm	AISI 304 Satin	2	24,55 p/s
<b>15.0312.042.16</b>	42,4 x 2,6 mm	AISI 316 Satin	2	31,10 p/s
<b>15.0312.048.15</b>	48,3 x 2,0 mm	AISI 304 Satin	2	31,10 p/s
<b>15.0312.048.16</b>	48,3 x 2,0 mm	AISI 316 Satin	2	41,05 p/s

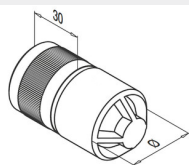

MODEL	Ø			€
<b>15.0790.242.15</b>	42,4 x 2,0 mm	AISI 304 Satin	2	7,20 p/s
<b>15.0790.242.16</b>	42,4 x 2,0 mm	AISI 316 Satin	2	9,40 p/s
<b>15.0790.042.15</b>	42,4 x 2,6 mm	AISI 304 Satin	2	7,20 p/s
<b>15.0790.042.16</b>	42,4 x 2,6 mm	AISI 316 Satin	2	9,40 p/s
<b>15.0790.048.15</b>	48,3 x 2,0 mm	AISI 304 Satin	2	9,30 p/s
<b>15.0790.048.16</b>	48,3 x 2,0 mm	AISI 316 Satin	2	12,20 p/s



MODEL	Ø			€
<b>15.5792.242.15</b>	42,4 x 2,0 mm	AISI 304 Satin	2	6,70 p/s
<b>15.5792.242.16</b>	42,4 x 2,0 mm	AISI 316 Satin	2	8,70 p/s
<b>15.5792.042.15</b>	42,4 x 2,6 mm	AISI 304 Satin	2	6,70 p/s
<b>15.5792.042.16</b>	42,4 x 2,6 mm	AISI 316 Satin	2	8,70 p/s
<b>15.5792.048.15</b>	48,3 x 2,0 mm	AISI 304 Satin	2	8,70 p/s
<b>15.5792.048.16</b>	48,3 x 2,0 mm	AISI 316 Satin	2	11,30 p/s

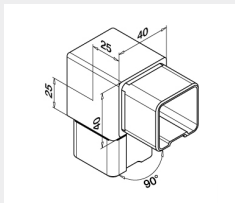

MODEL	∅			€
<b>15.4301.040.15</b>	40 x 40 x 2 mm	AISI 304 Satin	2	15,80 p/s
<b>15.4301.040.16</b>	40 x 40 x 2 mm	AISI 316 Satin	2	20,60 p/s



High quality Glue  
50 ml.  
**15.0000.000.15**



**GEPOEDERCOAT  
IN ELKE  
GEWENSTE KLEUR**

24



**OOG  
VOOR DETAIL**

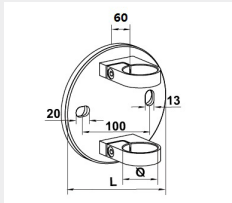

MODEL	Ø			€
<b>15.0551.042.15</b>	42,4 mm	AISI 304 Satin	1	46,50 p/s
<b>15.0551.042.16</b>	42,4 mm	AISI 316 Satin	1	63,95 p/s
<b>15.0551.048.15</b>	48,3 mm	AISI 304 Satin	1	48,80 p/s
<b>15.0551.048.16</b>	48,3 mm	AISI 316 Satin	1	66,95 p/s

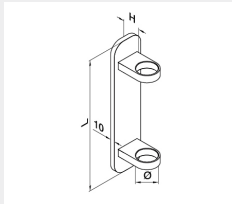

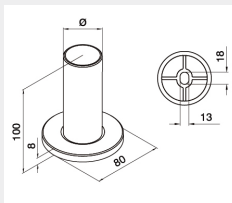

MODEL	Ø			€
<b>15.0557.042.15</b>	42,4 mm	AISI 304 Satin	1	45,95 p/s
<b>15.0557.042.16</b>	42,4 mm	AISI 316 Satin	1	60,65 p/s
<b>15.0557.048.15</b>	48,3 mm	AISI 304 Satin	1	49,35 p/s
<b>15.0557.048.16</b>	48,3 mm	AISI 316 Satin	1	64,10 p/s

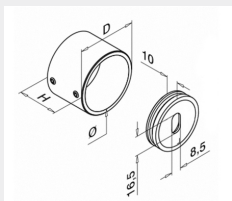

MODEL	Ø			€
<b>15.0946.242.15</b>	42,4 x 2 mm	AISI 304 Satin	2	24,55 p/s
<b>15.0946.242.16</b>	42,4 x 2 mm	AISI 316 Satin	2	29,30 p/s



MODEL	Ø			€
<b>15.0504.033.15</b>	33,7 mm x D 41 mm x H 30 mm	AISI 304 Satin	2	7,90 p/s
<b>15.0504.033.16</b>	33,7 mm x D 41 mm x H 30 mm	AISI 316 Satin	2	10,40 p/s
<b>15.0504.042.15</b>	42,4 mm x D 50 mm x H 35 mm	AISI 304 Satin	2	11,35 p/s
<b>15.0504.042.16</b>	42,4 mm x D 50 mm x H 35 mm	AISI 316 Satin	2	14,85 p/s



**AANDACHT  
VOOR VEILIGHEID**

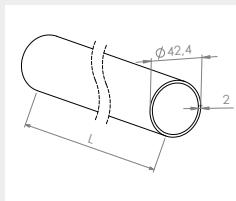

MODEL	Ø	L		€
<b>20.8929.242.15</b>	42,4 x 2,0 mm	2995	1	77,70 p/s
<b>20.8929.242.16</b>	42,4 x 2,0 mm	2995	1	101,60 p/s
<b>20.8959.242.15</b>	42,4 x 2,0 mm	5990	1	155,40 p/s
<b>20.8959.242.16</b>	42,4 x 2,0 mm	5990	1	203,20 p/s

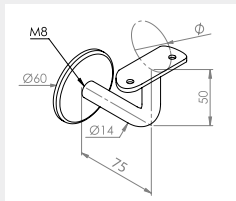

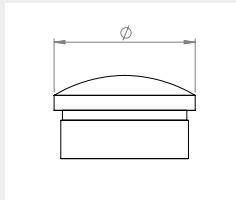

MODEL	Ø			€
<b>20.0111.042.15</b>	42,4 mm	AISI 304 Polish	2	12,20 p/s
<b>20.0111.042.16</b>	42,4 mm	AISI 316 Satin	2	17,55 p/s



MODEL	Ø			€
<b>20.0729.242.15</b>	42,4 mm x 2,0 mm	AISI 304 Polish	2	4,70 p/s
<b>20.0729.242.16</b>	42,4 mm x 2,0 mm	AISI 316 Satin	2	6,75 p/s

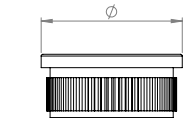



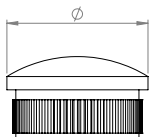
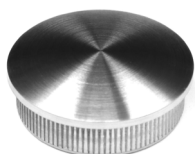

MODEL	Ø			€
<b>15.5732.033.15</b>	33,7 mm x 2.0 mm	AISI 304 Satin	2	3,55 p/s
<b>15.5732.242.15</b>	42,4 mm x 2.0 mm	AISI 304 Satin	2	3,80 p/s
<b>15.5732.242.16</b>	42,4 mm x 2.0 mm	AISI 316 Satin	2	4,85 p/s
<b>15.5732.042.15</b>	42,4 mm x 2.6 mm	AISI 304 Satin	2	3,80 p/s
<b>15.5732.042.16</b>	42,4 mm x 2.6 mm	AISI 316 Satin	2	4,85 p/s
<b>15.5732.048.15</b>	48,3 mm x 2.0 mm	AISI 304 Satin	2	3,90 p/s
<b>15.5732.048.16</b>	48,3 mm x 2.0 mm	AISI 316 Satin	2	5,05 p/s

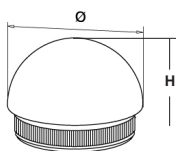

MODEL	Ø			€
<b>15.5729.033.15</b>	33,7 mm x 2.0 mm	AISI 304 Satin	2	3,55 p/s
<b>15.5729.242.15</b>	42,4 mm x 2.0 mm	AISI 304 Satin	2	3,80 p/s
<b>15.5729.242.16</b>	42,4 mm x 2.0 mm	AISI 316 Satin	2	4,85 p/s
<b>15.5729.042.15</b>	42,4 mm x 2.6 mm	AISI 304 Satin	2	3,80 p/s
<b>15.5729.042.16</b>	42,4 mm x 2.6 mm	AISI 316 Satin	2	4,85 p/s
<b>15.5729.048.15</b>	48,3 mm x 2.0 mm	AISI 304 Satin	2	3,90 p/s
<b>15.5729.048.16</b>	48,3 mm x 2.0 mm	AISI 316 Satin	2	5,05 p/s





MODEL	Ø			€
<b>15.5732.033.15</b>	33,7 mm x 2.0 mm	AISI 304 Satin	2	3,95 p/s
<b>15.5732.242.15</b>	42,4 mm x 2.0 mm	AISI 304 Satin	2	4,05 p/s
<b>15.5732.242.16</b>	42,4 mm x 2.0 mm	AISI 316 Satin	2	5,35 p/s
<b>15.5732.042.15</b>	42,4 mm x 2.6 mm	AISI 304 Satin	2	4,05 p/s
<b>15.5732.042.16</b>	42,4 mm x 2.6 mm	AISI 316 Satin	2	5,35 p/s
<b>15.5732.048.15</b>	48,3 mm x 2.0 mm	AISI 304 Satin	2	4,90 p/s
<b>15.5732.048.16</b>	48,3 mm x 2.0 mm	AISI 316 Satin	2	6,25 p/s

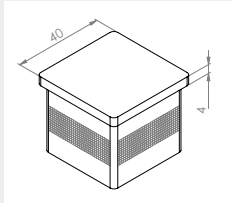



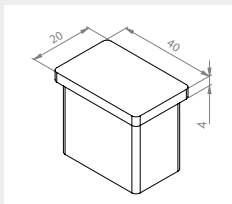



MODEL				€
<b>15.5728.040.15</b>	40 x 40 x 2 mm	AISI 304 Satin	2	5,70 p/s
<b>15.5728.040.16</b>	40 x 40 x 2 mm	AISI 316 Satin	2	6,85 p/s

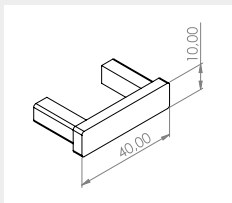

MODEL				€
<b>15.5728.402.15</b>	40 x 20 x 2 mm	AISI 304 Satin	2	4,70 p/s



MODEL				€
<b>15.4732.041.15</b>	40 x 10 x 1,5 mm	AISI 304 Satin	2	4,25 p/s
<b>15.4732.041.16</b>	40 x 10 x 1,5 mm	AISI 316 Satin	2	5,60 p/s

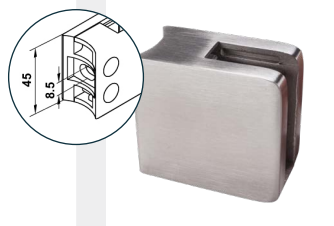

MODEL	Ø			€
<b>Glasdikte 8,76 mm</b>				
<b>16.4545.042.15</b>	45 mm x 45 mm x 42,4 mm	AISI 304 Satin	4	9,35 p/s
<b>16.4545.042.16</b>	45 mm x 45 mm x 42,4 mm	AISI 316 Satin	4	10,75 p/s
Rubber Gaskets worden meegeleverd (€ 0,30 p/s)				
<b>Glasdikte 10,76 mm</b>				
<b>16.4545.242.15</b>	45 mm x 45 mm x 42,4 mm	AISI 304 Satin	4	9,35 p/s
<b>16.4545.242.16</b>	45 mm x 45 mm x 42,4 mm	AISI 316 Satin	4	10,75 p/s
Rubber Gaskets worden meegeleverd (€ 0,30 p/s)				

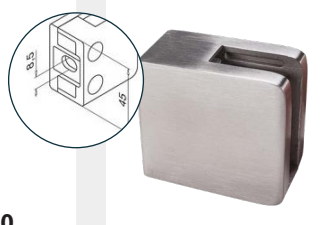
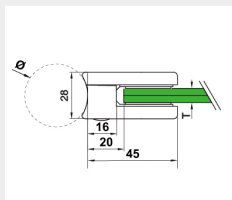

MODEL	□			€
<b>Glasdikte 8,76 mm</b>				
<b>15.4545.000.15</b>	45 mm x 45 mm x flat	AISI 304 Satin	4	9,35 p/s
<b>15.4545.000.16</b>	45 mm x 45 mm x flat	AISI 316 Satin	4	10,75 p/s
Rubber Gaskets worden meegeleverd (€ 0,30 p/s)				
<b>Glasdikte 10,76 mm</b>				
<b>15.4545.200.15</b>	45 mm x 45 mm x flat	AISI 304 Satin	4	9,35 p/s
<b>15.4545.200.16</b>	45 mm x 45 mm x flat	AISI 316 Satin	4	10,75 p/s
Rubber Gaskets worden meegeleverd (€ 0,30 p/s)				

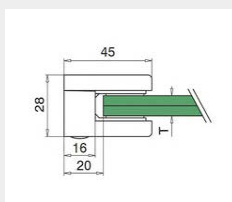



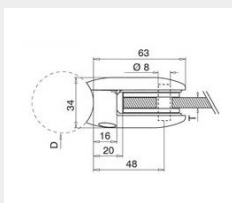
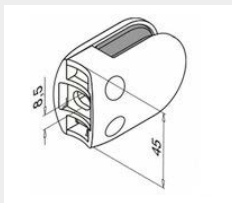

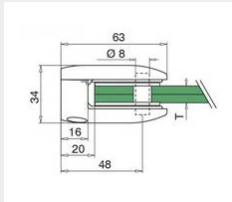
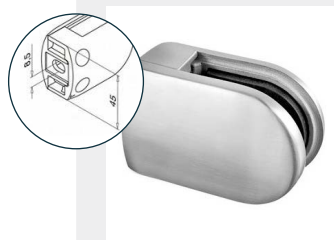

MODEL	Ø			€
<b>Glasdikte 8,76 mm</b>				
<b>15.2809.042.15</b>	45 mm x 63 mm x 42,4 mm	AISI 304 Satin	4	11,00 p/s
<b>15.2809.042.16</b>	45 mm x 63 mm x 42,4 mm	AISI 316 Satin	4	12,30 p/s
Rubber Gaskets worden meegeleverd (€ 0,30 p/s)				
<b>Glasdikte 10,76 mm</b>				
<b>15.2809.242.15</b>	45 mm x 63 mm x 42,4 mm	AISI 304 Satin	4	11,00 p/s
<b>15.2809.242.16</b>	45 mm x 63 mm x 42,4 mm	AISI 316 Satin	4	12,30 p/s
Rubber Gaskets worden meegeleverd (€ 0,30 p/s)				
<b>Glasdikte 8,76 mm</b>				
<b>15.2809.048.15</b>	45 mm x 63 mm x 48,3 mm	AISI 304 Satin	4	11,00 p/s
<b>15.2809.048.16</b>	45 mm x 63 mm x 48,3 mm	AISI 316 Satin	4	12,30 p/s
Rubber Gaskets worden meegeleverd (€ 0,30 p/s)				
<b>Glasdikte 10,76 mm</b>				
<b>15.2809.248.15</b>	45 mm x 63 mm x 48,3 mm	AISI 304 Satin	4	11,00 p/s
<b>15.2809.248.16</b>	45 mm x 63 mm x 48,3 mm	AISI 316 Satin	4	12,30 p/s
Rubber Gaskets worden meegeleverd (€ 0,30 p/s)				

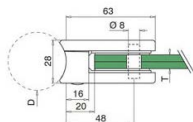
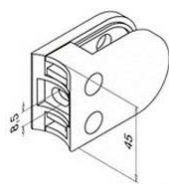

MODEL	□			€
<b>Glasdikte 8,76 mm</b>				
<b>15.2809.000.15</b>	45 mm x 63 mm x 42,4 mm	AISI 304 Satin	4	11,00 p/s
<b>15.2809.000.16</b>	45 mm x 63 mm x 42,4 mm	AISI 316 Satin	4	12,30 p/s
Rubber Gaskets worden meegeleverd (€ 0,30 p/s)				
<b>Glasdikte 10,76 mm</b>				
<b>15.2809.200.15</b>	45 mm x 63 mm x 42,4 mm	AISI 304 Satin	4	11,00 p/s
<b>15.2809.200.16</b>	45 mm x 63 mm x 42,4 mm	AISI 316 Satin	4	12,30 p/s
Rubber Gaskets worden meegeleverd (€ 0,30 p/s)				



MODEL	Ø			€
<b>Glasdikte 8,76 mm</b>				
<b>15.2209.042.15</b>	45 mm x 63 mm x 42,4 mm	AISI 304 Satin	4	11,00 p/s
<b>15.2209.042.16</b>	45 mm x 63 mm x 42,4 mm	AISI 316 Satin	4	12,30 p/s
Rubber Gaskets worden meegeleverd (€ 0,30 p/s)				
<b>Glasdikte 10,76 mm</b>				
<b>15.2209.242.15</b>	45 mm x 63 mm x 42,4 mm	AISI 304 Satin	4	11,00 p/s
<b>15.2209.242.16</b>	45 mm x 63 mm x 42,4 mm	AISI 316 Satin	4	12,30 p/s
Rubber Gaskets worden meegeleverd (€ 0,30 p/s)				
<b>Glasdikte 8,76 mm</b>				
<b>15.2209.048.15</b>	45 mm x 63 mm x 48,3 mm	AISI 304 Satin	4	11,00 p/s
<b>15.2209.048.16</b>	45 mm x 63 mm x 48,3 mm	AISI 316 Satin	4	12,30 p/s
Rubber Gaskets worden meegeleverd (€ 0,30 p/s)				
<b>Glasdikte 10,76 mm</b>				
<b>15.2209.248.15</b>	45 mm x 63 mm x 48,3 mm	AISI 304 Satin	4	11,00 p/s
<b>15.2209.248.16</b>	45 mm x 63 mm x 48,3 mm	AISI 316 Satin	4	12,30 p/s
Rubber Gaskets worden meegeleverd (€ 0,30 p/s)				

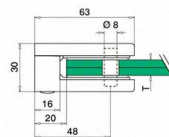
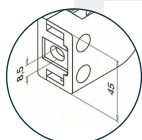

MODEL	□			€
<b>Glasdikte 8,76 mm</b>				
<b>15.2209.000.15</b>	45 mm x 63 mm x 42,4 mm	AISI 304 Satin	4	11,00 p/s
<b>15.2209.000.16</b>	45 mm x 63 mm x 42,4 mm	AISI 316 Satin	4	12,30 p/s
Rubber Gaskets worden meegeleverd (€ 0,30 p/s)				
<b>Glasdikte 10,76 mm</b>				
<b>15.2209.200.15</b>	45 mm x 63 mm x 42,4 mm	AISI 304 Satin	4	11,00 p/s
<b>15.2209.200.16</b>	45 mm x 63 mm x 42,4 mm	AISI 316 Satin	4	12,30 p/s
Rubber Gaskets worden meegeleverd (€ 0,30 p/s)				

34



**STRAK EN  
STIJLVOL**

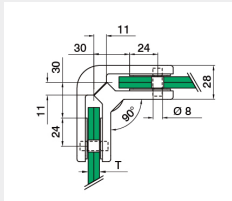

MODEL	<input type="checkbox"/>			€
<b>Glasdikte 8,76 mm</b>				
<b>15.2906.000.15</b>	45 mm x 35 mm x 35 mm	AISI 304 Satin	4	36,35 p/s
<b>15.2906.000.16</b>	45 mm x 35 mm x 35 mm	AISI 316 Satin	4	44,90 p/s
Rubber Gaskets worden meegeleverd (€ 0,30 p/s)				
<b>Glasdikte 10,76 mm</b>				
<b>15.2906.200.15</b>	45 mm x 35 mm x 35 mm	AISI 304 Satin	4	36,35 p/s
<b>15.2906.200.16</b>	45 mm x 35 mm x 35 mm	AISI 316 Satin	4	44,90 p/s
Rubber Gaskets worden meegeleverd (€ 0,30 p/s)				

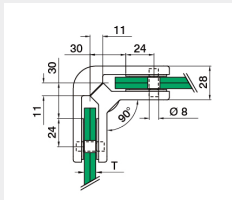

MODEL	<input type="checkbox"/>			€
<b>Glasdikte 8,76 mm</b>				
<b>15.3006.000.15</b>	45 mm x 35 mm x 35 mm	AISI 304 Satin	4	39,90 p/s
<b>15.3006.000.16</b>	45 mm x 35 mm x 35 mm	AISI 316 Satin	4	44,90 p/s
Rubber Gaskets worden meegeleverd (€ 0,30 p/s)				
<b>Glasdikte 10,76 mm</b>				
<b>15.3006.200.15</b>	45 mm x 35 mm x 35 mm	AISI 304 Satin	4	39,90 p/s
<b>15.3006.200.16</b>	45 mm x 35 mm x 35 mm	AISI 316 Satin	4	44,90 p/s
Rubber Gaskets worden meegeleverd (€ 0,30 p/s)				







# CREATIEVE OPLOSSINGEN

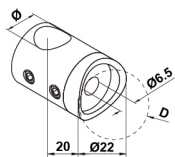
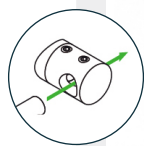

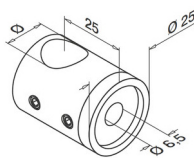
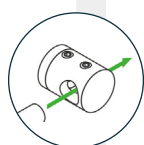

MODEL	Ø			€
<b>15.0830.042.15</b>	42,4 mm x 12 mm	AISI 304 Satin	4	2,90 p/s
<b>15.0830.042.16</b>	42,4 mm x 12 mm	AISI 316 Satin	4	4,90 p/s
<b>15.0830.048.15</b>	48,3 mm x 12 mm	AISI 304 Satin	4	2,90 p/s
<b>15.0830.048.16</b>	48,3 mm x 12 mm	AISI 316 Satin	4	4,90 p/s



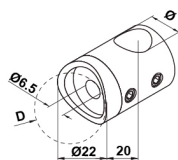
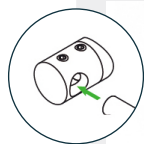

MODEL	□			€
<b>15.0830.000.15</b>	12 mm x flat	AISI 304 Satin	4	2,90 p/s
<b>15.0830.000.16</b>	12 mm x flat	AISI 316 Satin	4	4,90 p/s

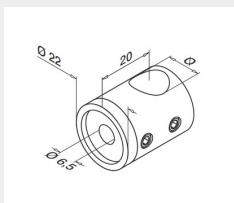
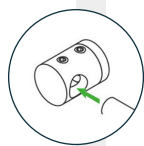

MODEL	Ø			€
<b>15.0833.042.15</b>	42,4 mm x 12 mm	AISI 304 Satin	4	2,90 p/s
<b>15.0833.042.16</b>	42,4 mm x 12 mm	AISI 316 Satin	4	4,90 p/s
<b>15.0833.048.15</b>	48,3 mm x 12 mm	AISI 304 Satin	4	2,90 p/s
<b>15.0833.048.16</b>	48,3 mm x 12 mm	AISI 316 Satin	4	4,90 p/s



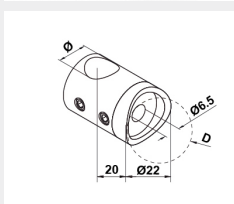

MODEL	□			€
<b>15.0833.000.15</b>	12 mm x flat	AISI 304 Satin	4	2,90 p/s
<b>15.0833.000.16</b>	12 mm x flat	AISI 316 Satin	4	4,90 p/s



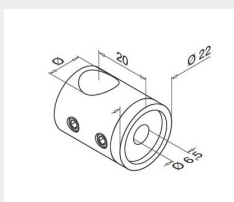
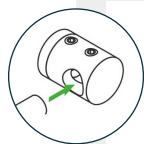

MODEL	∅			€
<b>15.0832.042.15</b>	42,4 mm x 12 mm	AISI 304 Satin	4	2,90 p/s
<b>15.0832.042.16</b>	42,4 mm x 12 mm	AISI 316 Satin	4	4,90 p/s
<b>15.0832.048.15</b>	48,3 mm x 12 mm	AISI 304 Satin	4	2,90 p/s
<b>15.0832.048.16</b>	48,3 mm x 12 mm	AISI 316 Satin	4	4,90 p/s

38



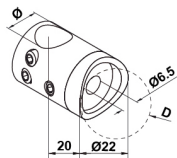
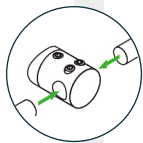

MODEL	□			€
<b>15.0832.000.15</b>	12 mm x flat	AISI 304 Satin	2	2,90 p/s
<b>15.0832.000.16</b>	12 mm x flat	AISI 304 Satin	2	4,90 p/s

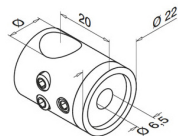
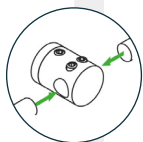

MODEL	Ø			€
<b>15.0831.042.15</b>	42,4 mm x 12 mm	AISI 304 Satin	4	2,90 p/s
<b>15.0831.042.16</b>	42,4 mm x 12 mm	AISI 316 Satin	4	4,90 p/s
<b>15.0830.048.15</b>	48,3 mm x 12 mm	AISI 304 Satin	4	2,90 p/s
<b>15.0830.048.16</b>	48,3 mm x 12 mm	AISI 316 Satin	4	4,90 p/s



MODEL	□			€
<b>15.0831.000.15</b>	12 mm x flat	AISI 304 Satin	4	2,90 p/s
<b>15.0831.000.16</b>	12 mm x flat	AISI 316 Satin	4	4,90 p/s

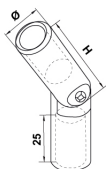

MODEL	Ø			€
<b>15.0302.012.15</b>	12 x 36 mm	AISI 304 Satin	6	11,15 p/s
<b>15.0302.012.16</b>	12 x 36 mm	AISI 316 Satin	6	14,65 p/s

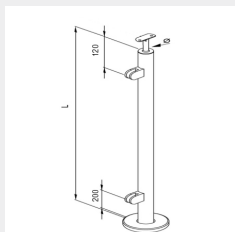
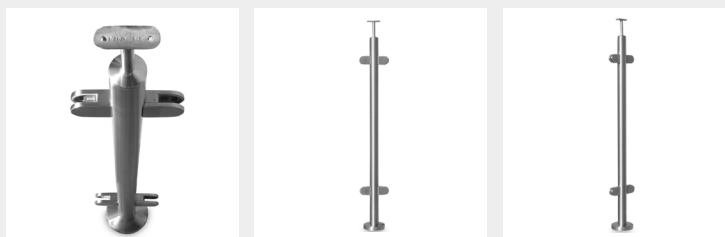

MODEL	Ø	L		€
<b>15.0922.242.15</b>	42,4 x 2,0 mm	900	1	51,40 p/s
<b>15.0922.042.15</b>	42,4 x 2,6 mm	900	1	55,40 p/s
<b>15.0922.242.16</b>	42,4 x 2,0 mm	900	1	63,60 p/s
<b>15.0922.042.16</b>	42,4 x 2,6 mm	900	1	67,60 p/s

40

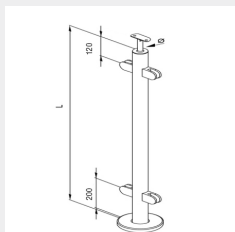

MODEL	Ø	L		€
<b>15.0944.242.15</b>	42,4 x 2,0 mm	900	1	51,40 p/s
<b>15.0944.042.15</b>	42,4 x 2,6 mm	900	1	55,40 p/s
<b>15.0944.242.16</b>	42,4 x 2,0 mm	900	1	63,60 p/s
<b>15.0944.042.16</b>	42,4 x 2,6 mm	900	1	67,60 p/s

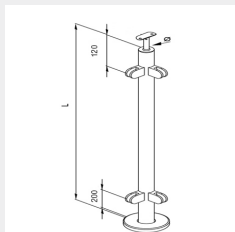

MODEL	Ø	L		€
<b>15.0966.242.15</b>	42,4 x 2,0 mm	900	1	51,40 p/s
<b>15.0966.042.15</b>	42,4 x 2,0 mm	900	1	55,40 p/s
<b>15.0966.242.16</b>	42,4 x 2,0 mm	900	1	63,60 p/s
<b>15.0966.042.16</b>	42,4 x 2,0 mm	900	1	67,60 p/s

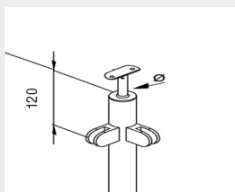

**LET OP:**

Bovenstaande staanders zijn niet voorzien van doppen/handrailingsteunen aan de bovenzijde. Ook de glasklemmen worden niet standaard bijgeleverd, de gaten zijn wel voorberekt. De staanders zijn standaard voorzien van een flens en bijbehorende afdekkap. Kies de gewenste doppen/handrailingsteunen en glasklemmen onder de rubriek 'eindkappen', 'handrailingsteunen' en 'glasklemmen'.



**FUNCTIONEEL  
MAATWERK**



**ONZE SPECIALISTEN  
DENKEN MET U MEE**



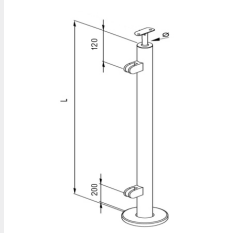
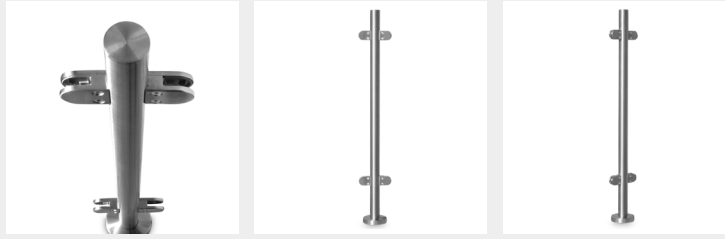

MODEL	Ø	L		€
<b>15.0933.242.15</b>	42,4 x 2,0 mm	970	1	51,40 p/s
<b>15.0933.042.15</b>	42,4 x 2,6 mm	970	1	55,40 p/s
<b>15.0933.242.16</b>	42,4 x 2,0 mm	970	1	63,60 p/s
<b>15.0933.042.16</b>	42,4 x 2,6 mm	970	1	67,60 p/s

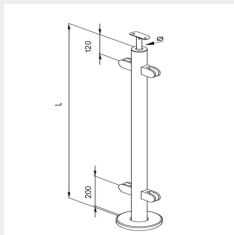

MODEL	Ø	L		€
<b>15.0955.242.15</b>	42,4 x 2,0 mm	970	1	51,40 p/s
<b>15.0955.042.15</b>	42,4 x 2,6 mm	970	1	55,40 p/s
<b>15.0955.242.16</b>	42,4 x 2,0 mm	970	1	63,60 p/s
<b>15.0955.042.16</b>	42,4 x 2,6 mm	970	1	67,60 p/s

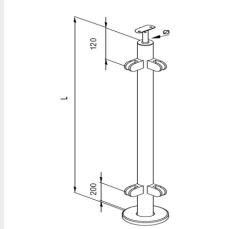

MODEL	Ø	L		€
<b>15.0977.242.15</b>	42,4 x 2,0 mm	970	1	51,40 p/s
<b>15.0977.042.15</b>	42,4 x 2,0 mm	970	1	55,40 p/s
<b>15.0977.242.16</b>	42,4 x 2,0 mm	970	1	63,60 p/s
<b>15.0977.042.16</b>	42,4 x 2,0 mm	970	1	67,60 p/s

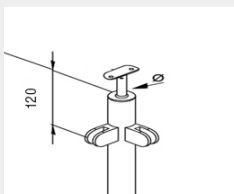
**LET OP:**

Bovenstaande staanders zijn niet voorzien van doppen/handrailingsteunen aan de bovenzijde. Ook de glasklemmen worden niet standaard bijgeleverd, de gaten zijn wel voorberekt. De staanders zijn standaard voorzien van een flens en bijbehorende afdekkap. Kies de gewenste doppen/handrailingsteunen en glasklemmen onder de rubriek 'eindkappen', 'handrailingsteunen' en 'glasklemmen'.

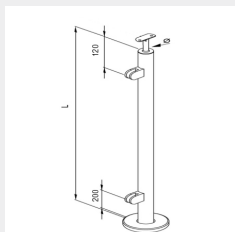
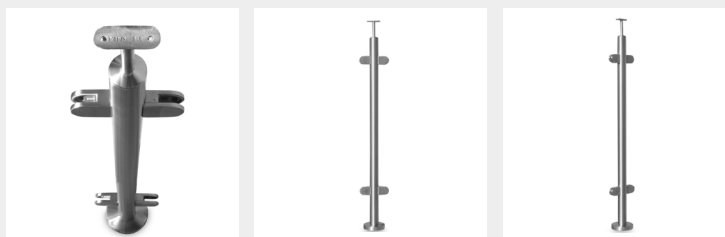

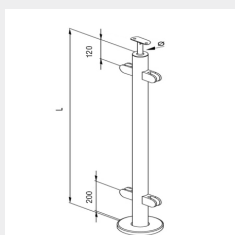

MODEL	Ø	L		€
<b>15.0922.248.15</b>	42,4 x 2,0 mm	900	1	57,40 p/s
<b>15.0922.048.15</b>	42,4 x 2,6 mm	900	1	61,40 p/s
<b>15.0922.248.16</b>	42,4 x 2,0 mm	900	1	69,60 p/s
<b>15.0922.048.16</b>	42,4 x 2,6 mm	900	1	73,60 p/s

44

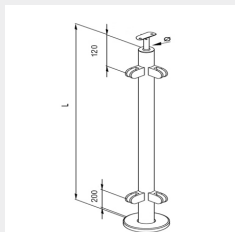

MODEL	Ø	L		€
<b>15.0944.248.15</b>	42,4 x 2,0 mm	900	1	57,40 p/s
<b>15.0944.048.15</b>	42,4 x 2,6 mm	900	1	61,40 p/s
<b>15.0944.248.16</b>	42,4 x 2,0 mm	900	1	69,60 p/s
<b>15.0944.048.16</b>	42,4 x 2,6 mm	900	1	73,60 p/s



MODEL	Ø	L		€
<b>15.0966.248.15</b>	42,4 x 2,0 mm	900	1	57,40 p/s
<b>15.0966.048.15</b>	42,4 x 2,0 mm	900	1	61,40 p/s
<b>15.0966.248.16</b>	42,4 x 2,0 mm	900	1	69,60 p/s
<b>15.0966.048.16</b>	42,4 x 2,0 mm	900	1	73,60 p/s

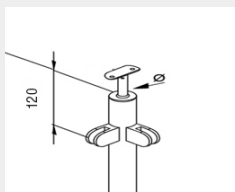

**LET OP:**

Bovenstaande staanders zijn niet voorzien van doppen/handrailingsteunen aan de bovenzijde. Ook de glasklemmen worden niet standaard bijgeleverd, de gaten zijn wel voorberekt. De staanders zijn standaard voorzien van een flens en bijbehorende afdekkap. Kies de gewenste doppen/handrailingsteunen en glasklemmen onder de rubriek 'eindkappen', 'handrailingsteunen' en 'glasklemmen'.



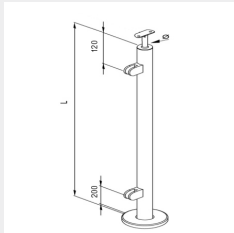

MODEL	Ø	L		€
<b>15.0933.248.15</b>	42,4 x 2,0 mm	970	1	57,40 p/s
<b>15.0933.048.15</b>	42,4 x 2,6 mm	970	1	61,40 p/s
<b>15.0933.248.16</b>	42,4 x 2,0 mm	970	1	69,60 p/s
<b>15.0933.048.16</b>	42,4 x 2,6 mm	970	1	73,60 p/s

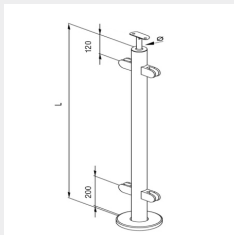

MODEL	Ø	L		€
<b>15.0955.248.15</b>	42,4 x 2,0 mm	970	1	57,40 p/s
<b>15.0955.048.15</b>	42,4 x 2,6 mm	970	1	61,40 p/s
<b>15.0955.248.16</b>	42,4 x 2,0 mm	970	1	69,60 p/s
<b>15.0955.048.16</b>	42,4 x 2,6 mm	970	1	73,60 p/s

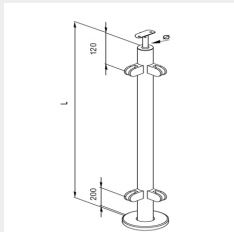

MODEL	Ø	L		€
<b>15.0977.248.15</b>	42,4 x 2,0 mm	970	1	57,40 p/s
<b>15.0977.048.15</b>	42,4 x 2,0 mm	970	1	61,40 p/s
<b>15.0977.248.16</b>	42,4 x 2,0 mm	970	1	69,60 p/s
<b>15.0977.048.16</b>	42,4 x 2,0 mm	970	1	73,60 p/s

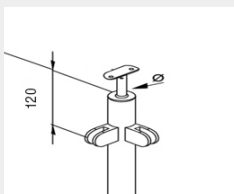

**LET OP:**

Bovenstaande staanders zijn niet voorzien van doppen/handrailingsteunen aan de bovenzijde. Ook de glasklemmen worden niet standaard bijgeleverd, de gaten zijn wel voorbereid. De staanders zijn standaard voorzien van een flens en bijbehorende afdekkap. Kies de gewenste doppen/handrailingsteunen en glasklemmen onder de rubriek 'eindkappen', 'handrailingsteunen' en 'glasklemmen'.

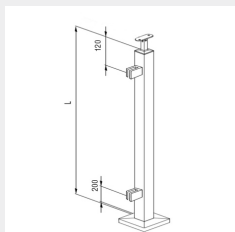

MODEL	□	L	📦	€
<b>15.0922.040.15</b>	40 x 40 x 2,0 mm	900	1	72,60 p/s
<b>15.0922.040.16</b>	40 x 40 x 2,0 mm	900	1	79,60 p/s
<b>15.0933.040.15</b>	40 x 40 x 2,0 mm	970	1	72,60 p/s
<b>15.0933.040.16</b>	40 x 40 x 2,0 mm	970	1	79,60 p/s

46

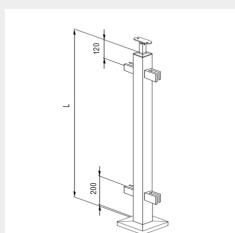

MODEL	□	L	📦	€
<b>15.0944.040.15</b>	40 x 40 x 2,0 mm	900	1	72,60 p/s
<b>15.0944.040.16</b>	40 x 40 x 2,0 mm	900	1	79,60 p/s
<b>15.0955.040.15</b>	40 x 40 x 2,0 mm	970	1	72,60 p/s
<b>15.0955.040.16</b>	40 x 40 x 2,0 mm	970	1	79,60 p/s

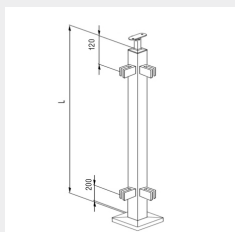

MODEL	□	L	📦	€
<b>15.0966.040.15</b>	40 x 40 x 2,0 mm	900	1	72,60 p/s
<b>15.0966.040.16</b>	40 x 40 x 2,0 mm	900	1	79,60 p/s
<b>15.0977.040.15</b>	40 x 40 x 2,0 mm	970	1	72,60 p/s
<b>15.0977.040.16</b>	40 x 40 x 2,0 mm	970	1	79,60 p/s

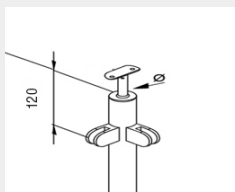

**LET OP:**

Bovenstaande staanders zijn niet voorzien van doppen/handrailingsteunen aan de bovenzijde. Ook de glasklemmen worden niet standaard bijgeleverd, de gaten zijn wel voorberekt. De staanders zijn standaard voorzien van een flens en bijbehorende afdekkap. Kies de gewenste doppen/handrailingsteunen en glasklemmen onder de rubriek 'eindkappen', 'handrailingsteunen' en 'glasklemmen'.



**STOER EN  
FUNCTIONEEL**

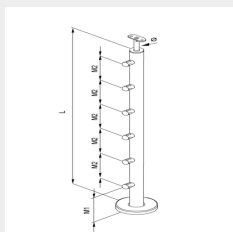

MODEL	Ø	L		€
<b>15.0906.242.15</b>	42,4 x 2,0 mm	900	1	56,20 p/s
<b>15.0906.042.15</b>	42,4 x 2,6 mm	900	1	58,20 p/s
<b>15.0906.242.16</b>	42,4 x 2,0 mm	900	1	74,20 p/s
<b>15.0906.042.16</b>	42,4 x 2,6 mm	900	1	76,20 p/s

48

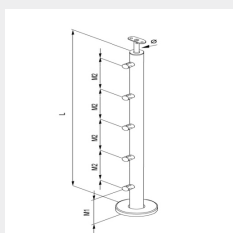

MODEL	Ø	L		€
<b>15.0905.242.15</b>	42,4 x 2,0 mm	900	1	55,20 p/s
<b>15.0905.042.15</b>	42,4 x 2,6 mm	900	1	57,20 p/s
<b>15.0905.242.16</b>	42,4 x 2,0 mm	900	1	73,20 p/s
<b>15.0905.042.16</b>	42,4 x 2,6 mm	900	1	75,20 p/s

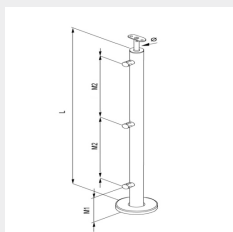

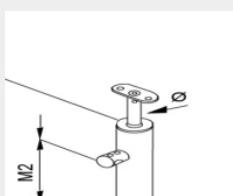

MODEL	Ø	L		€
<b>15.0903.242.15</b>	42,4 x 2,0 mm	900	1	53,20 p/s
<b>15.0903.042.15</b>	42,4 x 2,6 mm	900	1	55,20 p/s
<b>15.0903.242.16</b>	42,4 x 2,0 mm	900	1	71,20 p/s
<b>15.0903.042.16</b>	42,4 x 2,6 mm	900	1	73,20 p/s



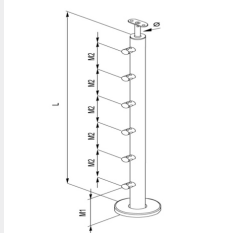

**LET OP:**

Bovenstaande staanders zijn niet voorzien van doppen/handrailingsteunen aan de bovenzijde. Ook de asverbinders worden niet standaard bijgeleverd, de gaten zijn wel voorberekt. De staanders zijn standaard voorzien van een flens en bijbehorende afdekkap. Kies de gewenste doppen/handrailingsteunen en asverbinders onder de rubriek 'eindkappen', 'handrailingsteunen' en 'asverbinders'.

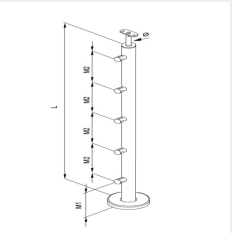

MODEL	Ø	L		€
<b>15.0976.242.15</b>	42,4 x 2,0 mm	970	1	56,20 p/s
<b>15.0976.042.15</b>	42,4 x 2,6 mm	970	1	58,20 p/s
<b>15.0976.242.16</b>	42,4 x 2,0 mm	970	1	74,20 p/s
<b>15.0976.042.16</b>	42,4 x 2,6 mm	970	1	76,20 p/s



MODEL	Ø	L		€
<b>15.0975.242.15</b>	42,4 x 2,0 mm	970	1	55,20 p/s
<b>15.0975.042.15</b>	42,4 x 2,6 mm	970	1	57,20 p/s
<b>15.0975.242.16</b>	42,4 x 2,0 mm	970	1	73,20 p/s
<b>15.0975.042.16</b>	42,4 x 2,6 mm	970	1	75,20 p/s

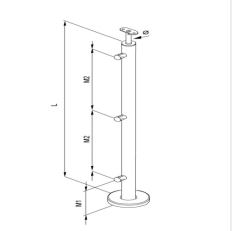

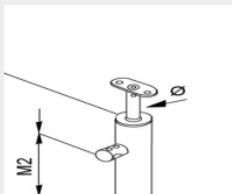

MODEL	Ø	L		€
<b>15.0973.242.15</b>	42,4 x 2,0 mm	970	1	53,20 p/s
<b>15.0973.042.15</b>	42,4 x 2,6 mm	970	1	55,20 p/s
<b>15.0973.242.16</b>	42,4 x 2,0 mm	970	1	71,20 p/s
<b>15.0973.042.16</b>	42,4 x 2,6 mm	970	1	73,20 p/s

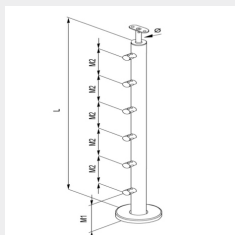

**LET OP:**

Bovenstaande standers zijn niet voorzien van doppen/handrailingsteunen aan de bovenzijde. Ook de asverbinders worden niet standaard bijgeleverd, de gaten zijn wel voorbereid. De standers zijn standaard voorzien van een flens en bijbehorende afdekkap. Kies de gewenste doppen/handrailingsteunen en asverbinders onder de rubriek 'eindkappen', 'handrailingsteunen' en 'asverbinders'.



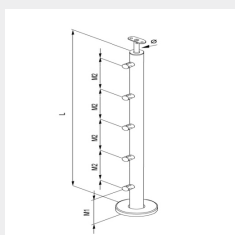

MODEL	Ø	L		€
<b>15.0906.248.15</b>	42,4 x 2,0 mm	900	1	62,20 p/s
<b>15.0906.048.15</b>	42,4 x 2,6 mm	900	1	64,20 p/s
<b>15.0906.248.16</b>	42,4 x 2,0 mm	900	1	80,20 p/s
<b>15.0906.048.16</b>	42,4 x 2,6 mm	900	1	84,20 p/s

50

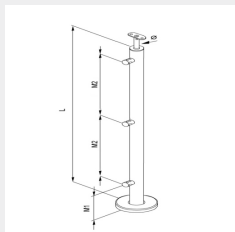

MODEL	Ø	L		€
<b>15.0905.248.15</b>	42,4 x 2,0 mm	900	1	59,20 p/s
<b>15.0905.048.15</b>	42,4 x 2,6 mm	900	1	63,20 p/s
<b>15.0905.248.16</b>	42,4 x 2,0 mm	900	1	79,20 p/s
<b>15.0905.048.16</b>	42,4 x 2,6 mm	900	1	81,20 p/s



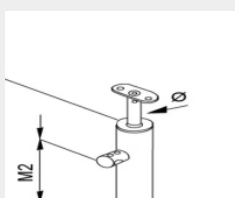

MODEL	Ø	L		€
<b>15.0903.248.15</b>	42,4 x 2,0 mm	900	1	59,20 p/s
<b>15.0903.048.15</b>	42,4 x 2,6 mm	900	1	61,20 p/s
<b>15.0903.248.16</b>	42,4 x 2,0 mm	900	1	77,20 p/s
<b>15.0903.048.16</b>	42,4 x 2,6 mm	900	1	79,20 p/s



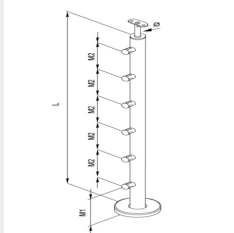

**LET OP:**

Bovenstaande staanders zijn niet voorzien van doppen/handrailingsteunen aan de bovenzijde. Ook de asverbinders worden niet standaard bijgeleverd, de gaten zijn wel voorberekt. De staanders zijn standaard voorzien van een flens en bijbehorende afdekkap. Kies de gewenste doppen/handrailingsteunen en asverbinders onder de rubriek 'eindkappen', 'handrailingsteunen' en 'asverbinders'.

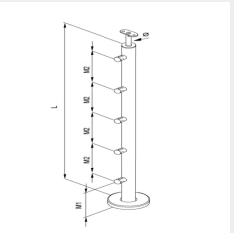

MODEL	Ø	L		€
<b>15.0976.248.15</b>	42,4 x 2,0 mm	970	1	62,20 p/s
<b>15.0976.048.15</b>	42,4 x 2,6 mm	970	1	54,20 p/s
<b>15.0976.248.16</b>	42,4 x 2,0 mm	970	1	80,20 p/s
<b>15.0976.048.16</b>	42,4 x 2,6 mm	970	1	84,20 p/s



MODEL	Ø	L		€
<b>15.0975.248.15</b>	42,4 x 2,0 mm	970	1	59,20 p/s
<b>15.0975.048.15</b>	42,4 x 2,6 mm	970	1	63,20 p/s
<b>15.0975.248.16</b>	42,4 x 2,0 mm	970	1	79,20 p/s
<b>15.0975.048.16</b>	42,4 x 2,6 mm	970	1	81,20 p/s

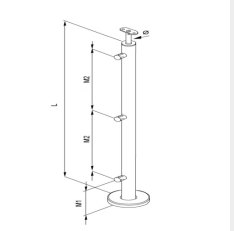

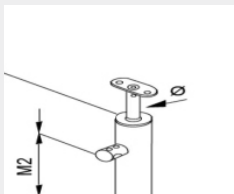

MODEL	Ø	L		€
<b>15.0973.248.15</b>	42,4 x 2,0 mm	970	1	59,20 p/s
<b>15.0973.048.15</b>	42,4 x 2,6 mm	970	1	61,20 p/s
<b>15.0973.248.16</b>	42,4 x 2,0 mm	970	1	77,20 p/s
<b>15.0973.048.16</b>	42,4 x 2,6 mm	970	1	79,20 p/s



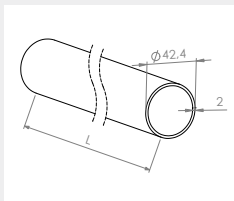

**LET OP:**

Bovenstaande standers zijn niet voorzien van doppen/handrailingsteunen aan de bovenzijde. Ook de asverbinders worden niet standaard bijgeleverd, de gaten zijn wel voorberekt. De standers zijn standaard voorzien van een flens en bijbehorende afdekkap. Kies de gewenste doppen/handrailingsteunen en asverbinders onder de rubriek 'eindkappen', 'handrailingsteunen' en 'asverbinders'.

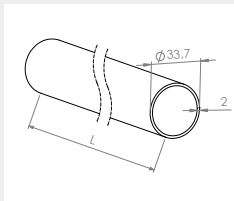

MODEL	$\emptyset$	L		€
<b>15.8929.242.15</b>	42,4 x 2,0 mm	2995	1	51,50 p/s
<b>15.8929.242.16</b>	42,4 x 2,0 mm	2995	1	73,30 p/s
<b>15.8959.242.15</b>	42,4 x 2,0 mm	5990	1	103,00 p/s
<b>15.8959.242.16</b>	42,4 x 2,0 mm	5990	1	146,60 p/s
<b>15.8929.042.15</b>	42,4 x 2,6 mm	2995	1	67,40 p/s
<b>15.8929.042.16</b>	42,4 x 2,6 mm	2995	1	92,60 p/s
<b>15.8959.042.15</b>	42,4 x 2,6 mm	5990	1	134,80 p/s
<b>15.8959.042.16</b>	42,4 x 2,6 mm	5990	1	185,20 p/s



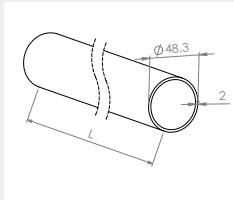

MODEL	$\emptyset$	L		€
<b>15.8929.233.15</b>	33,7 x 2,0 mm	2995	1	41,40 p/s
<b>15.8929.233.16</b>	33,7 x 2,0 mm	2995	1	56,90 p/s
<b>15.8959.233.15</b>	33,7 x 2,0 mm	5990	1	82,80 p/s
<b>15.8959.233.16</b>	33,7 x 2,0 mm	5990	1	113,80 p/s



MODEL	$\emptyset$	L		€
<b>15.8929.248.15</b>	48,3 x 2,0 mm	2995	1	62,40 p/s
<b>15.8929.248.16</b>	48,3 x 2,0 mm	2995	1	82,20 p/s
<b>15.8959.248.15</b>	48,3 x 2,0 mm	5990	1	124,80 p/s
<b>15.8959.248.16</b>	48,3 x 2,0 mm	5990	1	164,40 p/s

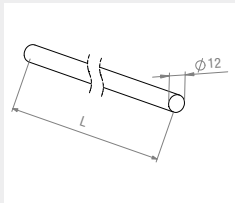



MODEL	Ø	L		€
<b>15.8929.012.15</b>	12 mm	2995	1	24,80 p/s
<b>15.8929.012.16</b>	12 mm	2995	1	37,10 p/s
<b>15.8959.012.15</b>	12 mm	5990	1	49,60 p/s
<b>15.8959.012.16</b>	12 mm	5990	1	74,20 p/s

54



**EXACTE  
MAATVOERING**

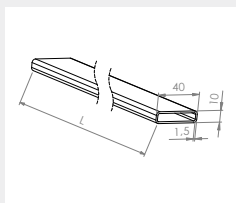

MODEL	□	L	📦	€
<b>15.4929.041.15</b>	40 x 10 x 1,5 mm	2995	1	37,10 p/s
<b>15.4929.041.16</b>	40 x 10 x 1,5 mm	2995	1	51,00 p/s
<b>15.4959.041.15</b>	40 x 10 x 1,5 mm	5990	1	74,20 p/s
<b>15.4959.041.16</b>	40 x 10 x 1,5 mm	5990	1	102,00 p/s

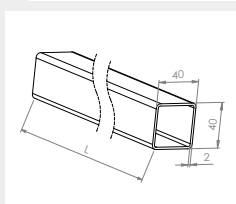

MODEL	□	L	📦	€
<b>15.4929.040.15</b>	40 x 40 x 2,0 mm	2995	1	73,10 p/s
<b>15.4929.040.16</b>	40 x 40 x 2,0 mm	2995	1	98,20 p/s
<b>15.4959.040.15</b>	40 x 40 x 2,0 mm	5990	1	146,20 p/s
<b>15.4959.040.16</b>	40 x 40 x 2,0 mm	5990	1	196,40 p/s

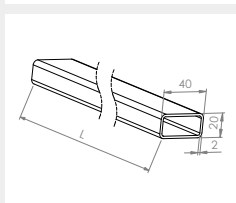

MODEL	□	L	📦	€
<b>15.4929.402.15</b>	40 x 20 x 2,0 mm	2995	1	42,50 p/s
<b>15.4929.402.16</b>	40 x 20 x 2,0 mm	2995	1	58,40 p/s
<b>15.4959.402.15</b>	40 x 20 x 2,0 mm	5990	1	85,00 p/s
<b>15.4959.402.16</b>	40 x 20 x 2,0 mm	5990	1	116,80 p/s





# METAALTECHNIEK

handelsonderneming b.v.

**Metaaltechniek is een technische groothandel die zich gespecialiseerd heeft in het schuur- en slijpproces. Onze meerwaarde ligt in het advies op de werkvloer om zo efficiënt mogelijk te werken. Naast een breed pakket aan schuur- en slijpmiddelen kunt u bij ons ook terecht voor diverse PBM's en tapes & lijmen.**

## Schuur- en slijpmiddelen

Schuur- en slijpmiddelen zijn het belangrijkste deel van ons pakket. Hier zijn we echt sterk in omdat er veel waarde valt toe te voegen voor de gebruiker. Bij ons advies laten we altijd de cijfers spreken. 'Testen' is voor ons dan ook het cruciale woord. De beste schijf is wat ons betreft die schijf die het snelst verspaant of slijpt, kortom waar het werk het snelst mee gedaan is. Arbeidskosten zijn nu eenmaal de zwaarst wegende factor.

Bij het bepalen van het beste slijpproduct vergelijken we niet alleen hetzelfde type van verschillende merken, maar kijken we ook of het gekozen product wel het meest geschikt is voor de klus.

## Altijd op de hoogte van de nieuwste ontwikkelingen

Welke schijven zijn er nieuw in de markt? We houden het allemaal voor u in de gaten. We doen zelf vergelijkende testen en als we denken dat een nieuw product voor u interessant kan zijn, dan zullen we die zeker bij u introduceren. Zo nemen we u veel werk uit handen en weet u zeker dat u altijd met de beste materialen werkt.

Naast de verbruiksmiddelen leveren we ook diverse pneumatische en elektrische handmachines en zijn we partner van Q-Fin, producent van automatische ontbraammachines.

## PBM's

Bij persoonlijke beschermingsmiddelen staat draagcomfort voorop. Een PBM mag het werk niet belemmeren. Wat comfortabel voelt verschilt van persoon tot persoon. Daarom voert Metaaltechniek een brede lijn las-, montage en werkhandschoenen, gehoor- en oogbescherming. Een kleine greep uit ons assortiment vindt u op de volgende pagina's.

## Tapes en lijmen

Zeker in de reling-wereld kan een tapeverbinding heel toepasbaar zijn. Advies over welke tape of lijm voor uw toepassing geschikt is, geven we graag bij u op de werkvloer. Eventueel nemen we de expert van 3M mee. Hij weet alles over eigenschappen met betrekking tot vocht, temperatuur en verschillende materialen. Maak vrijblijvend gebruik van zijn expertise. Naast bevestigingstape leveren wij ook afplak-, markeringstape en diverse beschermfolies.

Bij gebruik van tapes en lijmen is de voorbehandeling van het oppervlak belangrijk. Uiteraard kunt u bij ons ook terecht voor de ontvettingsmiddelen en diverse cleaners.

## Eigen label

Naast veel bekende merken voert Metaaltechniek ook een lijn producten onder eigen label. Producten waar we onze naam aan hebben verbonden en waar we dus ook vierkant achter staan. Meestal net wat gunstiger geprijsd, maar altijd een kwaliteitsproduct.

## METAC

Tot slot wijzen we nog op ons opleidingscentrum, de METAC. Hier worden ééndaagse trainingen gegeven op het juiste gebruik van schuur- en slijpmiddelen. Na een stuk theorie en veel praktijk keren de deelnemers veel wijzer terug naar huis.



**U kunt bij Metaaltechniek terecht voor veel verschillende veiligheids-handschoenen. Snijbestendig, montage- of lashandschoenen. Onze bestsellers vindt u hieronder op een rijtje. Zoekt u iets anders, neem dan gerust contact op.**

58



**Corium Welder handschoen**

Artikel MT34415  
€ 3,42 per paar  
verpakking per 12 paar

De MT34415 is een TIG lashandschoen met een rundnerfleder palm van 1,0 - 1,2 mm dikte en een splitleder rug en kap. De kritische naden zijn paspoil versterkt. Deze ongevoerde handschoen is voorzien van een splitleder polsversterking.



**Allround Nitrile handschoen**

Artikel MT10570  
€ 2,32 per paar  
verpakking per 12 paar

De MT10570 is een handschoen met een ademende nitril foam coating op de palm. Op de rug en vingers is de handschoen opengewerkt, wat zorgt voor goede ventilatie. De handschoen heeft een goede grip op droge, natte en olie-achtige ondergronden.



**Corium Canadian handschoen**

Artikel MT36170  
€ 1,89 per paar  
verpakking per 12 paar

De MT36170 is een werkhandschoen, type 'Amerikaantje', gemaakt van eersteklas rondsplitleer van 0,9 mm dikte. De handschoen heeft een goede molton voering voor extra comfort en vochtopname.



**Snijbestendige handschoen**

Artikel MT15600  
€ 5,22 per paar  
verpakking per 12 paar

De MT15600 is een snijbestendige handschoen klasse 5 met 13G HDPE/polyester liner met snijbestendige bescherming en PU handpalm. Op de rug en vingers is de handschoen opengewerkt wat zorgt voor goede ventilatie.



**3M Ear plugs**

Artikel 3MPP01002  
€ 0,13

Deze klassieke single-use oordoppen bieden een beschermingswaarde van 28 Db. Ideaal voor bezoekers maar ook voor eigen personeel. Bieden de hele dag maximale bescherming en geschikt voor vrijwel iedere gehoorgang.

**U kunt bij Metaaltechniek terecht voor diverse PBM's, waaronder de innovatieve Speedglas laskappen van 3M, slijpkappen, verschillende producten voor ademhalings-, gezichts- en gehoorbescherming.**



#### **Veiligheidsbril**

Artikel MT155440  
€ 2,01 per stuk

Deze heldere veiligheidsbril 568 Polycarbonaat heeft een uitstekende pasvorm en is krasvast. De MT1554400 is onze best verkochte bril, maar een getinte bril of een bril op sterkte is ook leverbaar.



#### **Peltor gehoorkap**

Artikel 3MOPTIME1  
€ 12,89  
inclusief gehoorbescherming

Uw (Peltor) gehoorkap bestelt u bij Metaaltechniek. De bekende gele kap biedt een bescherming van minimaal 27 db. Liever een andere gehoorbescherming? Neem contact met ons op!



#### **Speedglas lashelmen**

Metaaltechniek is Speedglas-dealer. Speedglas staat voor innovatie, comfort, veiligheid en gebruiksgemak. Veel modellen liggen op voorraad, inclusief onderdelen. Vraag vrijblijvend prijzen op of maak een afspraak voor een demo

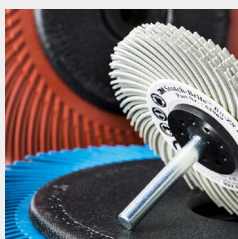

**Bristle Discs**

Prijs op aanvraag

Bristle discs worden gebruikt voor het verwijderen van lasverkleuringen, reinigen en licht ontbraamwerk. De kunststof haren bevatten een Cubitron korrel. Leverbaar in diverse uitvoeringen: met asgat, op stift of met roloc systeem.



**Combi-lamellenschijf K60**

Artikel KL312559 K60/coarse (geel/bruin)  
 Artikel KL312560 K80/medium (rood/bruin)  
 € 9,50 per stuk

Deze 125mm lamellenschijf bevat schuurlijnen gecombineerd met slijpvlies, zorgt voor materiaalafname en finishen in één stap.



**Lamellenschijf**

Artikel MFLAP12522CZ60  
 € 1,46 per stuk

De MFLAP is een uitstekende lamellenschijf. De standaard uitvoering is 125 x 22 Z060 en wordt gebruikt om af te ronden of een radius aan te brengen. Leverbaar in korrel 40-120 en in een vlakke of conische uitvoering.



**MSPEED Doorslijpschijf 1mm**

Artikel MSPEED12510INOX  
 € 0,99 per stuk

Na veel interne testen hebben we een doorslijpschijf gevonden die de naam van Metaaltechniek mag dragen. Geschikt voor staal en RVS. 125 x 1 x 22 mm.



**MSHINE Unitized Schijf**

Artikel Mshine125222AMED  
 € 6,65  
 Artikel Mshine125226AMED  
 € 8,32

Deze unitized schijf op glasvezel drager wordt gebruikt om lasverkleuringen te verwijderen en het oppervlak te verbeteren. Ø 125mm en leverbaar in 2A medium en 6A medium.



**Unitized Fast cut**

Ø 125mm x3x22mm € 13,05  
 Ø 125mm x6x22mm € 17,51  
 Ø 150mm x3x25.4mm € 18,27  
 Ø 150mm x6x25.4mm € 24,51

Deze schijf is uitstekend geschikt voor het afwerken van binnenhoeklassen. Beschikbaar in vier uitvoeringen.





**PTL Lamellenrollen**  
 Artikel MTPTL10050COCRS  
 € 8,12  
 Artikel MTPTL10050CRS  
 € 7,84  
 Artikel MTPTLAS100M14 (as)  
 € 52,99

PTL staat voor Push-Turn-Lock: zonder gereedschap uw rollen en schijven bevestigen. Beschikbaar met schuurlinnen, slijpvlies of een combinatie hiervan.



**Polijsmiddelen en slijpvetten**

Prijzen op aanvraag

Metaaltechniek is dealer van Menzerna, fabrikant van polijstpasta's. Daarnaast bieden we nog andere pasta's en vetten aan die nodig zijn bij het polijstproces.



**Haakse slijper**  
 Artikel MBWE15-125Q  
 € 199,00

De 1500W elektrische haakse slijper van Metabo is sterk genoeg om echt te verspanen. Stem vermogen en toerental af op uw applicatie! 11.000 Rpm, 125mm



**Plattekop Slijper**  
 Artikel SMFASET  
 € 319,00

De plattekop slijper wordt vaak gebruikt in combinatie met unitized schijven voor het bewerken van binnenhoeklassen. 1000W, 2000-7600 Rpm, 150 mm kap. Ook leverbaar met 125 mm kap.



**PTL Lappenschijven**  
 Artikel MTPTL15025KAT  
 150x25mm Katoen € 13,65  
 Artikel MTPTL15025SIKA  
 150x25mm Sisal/katoen € 17,28  
 Artikel MTPTL15025FLAN  
 150x25mm Flanel € 15,75  
 Artikel MTPTLAS50M14  
 50 mm as € 46,24

Er zijn ook verschillende lappenschijven verkrijgbaar met het PTL systeem. Zonder uitstekend boutje, dus minder kans op beschadigingen.



**MT-One Polijstmachine**  
 Artikel MT-ONE  
 € 288,00  
 Artikel MT-ONE-Guard  
 € 112,09

De MT-One is een 1200W machine en heeft een regelbaar toerental van 900-2810 Rpm. Uitgevoerd met een satineerkap is de machine uitermate geschikt voor satineren en borstelen.



**Metabo  
Buizenslijper**

Artikel MBRBE15-180  
€ 1.019,00

Een 1550W Buizenslijper met hoge treksterkte en grote omvatingshoek van 270°. De marathon-motor is extra beschermd tegen stof. Geschikt voor een maximale buisdiameter van 180 mm.

62



**Wilt u grote aantallen bestellen?  
Bel 033 - 455 87 88, we kijken samen  
naar de mogelijkheden.**

**Scotch Brite producten zijn ontwikkeld voor reinigen, afwerken en licht ontbraamwerk. Omdat het flexibel materiaal is, kunnen ook contouren heel goed bewerkt worden. We laten hier de handvellen en rollen zien, maar wilt u andere Scotch Brite producten, neem dan gerust contact op.**



**Schuurbanden**

Prijs afhankelijk van uitvoering, op aanvraag

Schuurbanden zijn leverbaar in alle soorten en maten. Van Powerfile-bandjes tot breed- of langbanden en alles wat er tussen in zit. Van een agressieve CubitronII tot een Scotch Brite band om te finishen. Alles is op maat te maken.



**Scotch Brite handpads**

Artikel 3M07447 (A-Very fine) € 1,37  
 Artikel 3M07440 (Medium) € 2,64

De handpads bevatten een schuurkorrel voor reinigen, finishen en verwijderen van imperfecties. Het non-woven nylon web zorgt voor maximale flexibiliteit. Afmeting 158x224 mm.



**Surface Condition Discs**

Artikel 3M60982 SC-DH SCD € 2,84

Deze schijf mag niet ontbreken als u RVS verwerkt. Ideaal voor licht ontbraamwerk, reinigen en finishen. Metaaltechniek levert diverse uitvoeringen tegen een uiterst scherpe prijs. Gebruik een SCD schijf altijd met de juiste steunschijf. 115 mm x 22 mm A MED



**Voorgeperforeerde handpads**

Artikel 3M07903 (A-Very fine) € 21,65  
 3M07904 (Ultra fine) € 23,03

De Scotch Brite Clean & Finish handpads zijn vooraf gesneden op rol aangebracht. De pads rafelen en roesten niet gedurende het gebruik en het laat een mooie finish achter.

**Metaaltechniek voert de complete lijn tapes en lijmen van 3M. Denk hierbij ook aan beschermfolie of alle reinigings- en ontvettingsmiddelen die nodig zijn voor een goede hechting. Laat u vrijblijvend adviseren over de mogelijkheden.**

64



### RVS Cleaner

Artikel 3MRVS12  
€ 9,47

Onmisbaar voor iedereen die RVS schoon wil maken en houden. Laat een onzichtbare beschermende film achter waardoor vuil zich minder kan hechten. Laat het product weer mooi glanzen. Bus, 600 ml.



### Universele biologische reiniger

Artikel MTCLEANER-1  
€ 9,02  
Artikel MTCLEANER-5  
€ 26,52

Een krachtige reiniger voor het reinigen van ruiten, meubilair, leuningen maar ook transportbanden. In spuitflacon of jerrycan.



### Beschermfolie 50 x 35.000 mm

Artikel 3M8009RX-50mm  
€ 26,80  
Andere afmetingen prijs op  
aanvraag

Aanbevolen voor de bescherming van gevoelige oppervlakken tegen vuil, stof, vingerafdrukken en beschadigingen gedurende de verwerking en transport van de materialen.





**Wilt u advies over welk product voor u het meest geschikt is en het snelst werkt? Bel 033 - 455 87 88, we kijken samen naar de mogelijkheden.**

# KIEZEN VOOR 4RAILING IS KIEZEN VOOR KWALITEIT

Alle producten vindt u op **[www.4railing.com](http://www.4railing.com)** en bestelt u eenvoudig. Komt u er niet helemaal uit? Dan zijn onze specialisten telefonisch bereikbaar, bel +31 (0)478 85 32 41, zij helpen u graag. Producten die op voorraad zijn worden dezelfde dag nog verstuurd.

Vindt u niet wat u zoekt? Neem gerust contact met ons op en daag onze specialisten uit. We leveren ook maatwerk als dat nodig is. Profiteer van onze kennis en ruime ervaring.

U bent van harte welkom!

**Team 4Railing**

#### **DISCLAIMER**

Alle informatie, maten en prijzen in deze catalogus zijn onder voorbehoud van typefouten en wijzigingen.

Alle rechten voorbehouden.

Niets uit deze catalogus mag worden verveelvoudigd, opgeslagen en/of openbaar worden gemaakt, zonder voorafgaande schriftelijke toestemming van 4Railing BV.



**4Railing BV**

T +31 (0)478 85 32 41

[info@4railing.com](mailto:info@4railing.com)

[www.4railing.com](http://www.4railing.com)