

ETHERNET NETWORKING

Installation and Operations Manual

531906-3EN_A

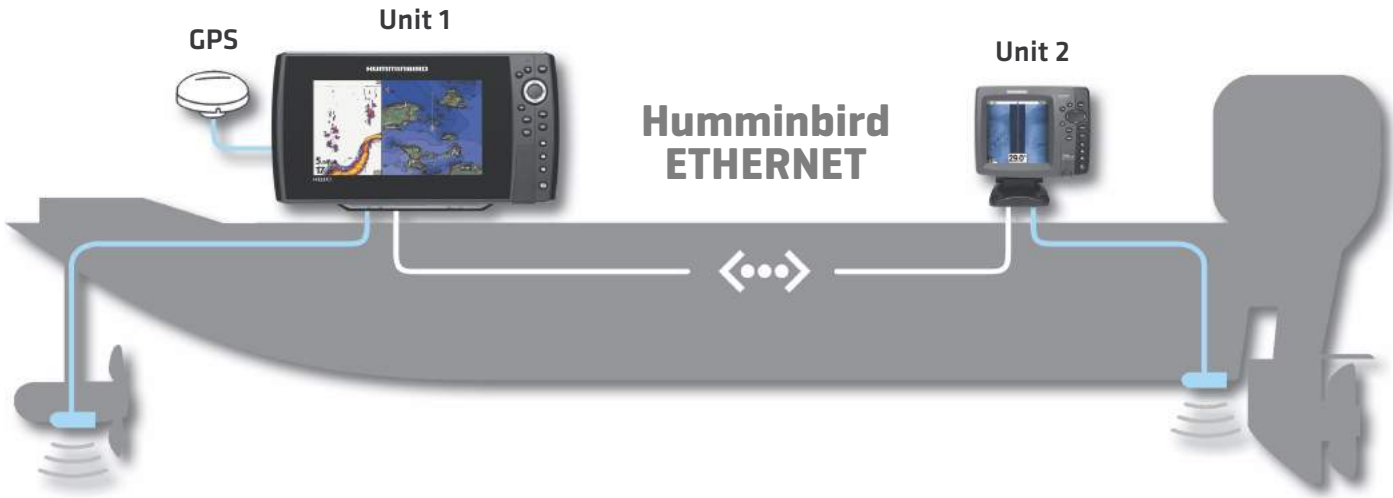



SIMPLY. CLEARLY. BETTER.

THANK YOU!

Thank you for choosing Humminbird®, the #1 name in marine electronics. Humminbird has built its reputation by designing and manufacturing top quality, thoroughly reliable marine equipment. Your Humminbird is designed for trouble-free use in even the harshest marine environment. We encourage you to read this manual carefully in order to get the full benefit from all the features and applications of your Humminbird product.

Contact Humminbird Customer Service at humminbird.com or call **1-800-633-1468**.

 **WARNING!** This device should not be used as a navigational aid to prevent collision, grounding, boat damage, or personal injury. When the boat is moving, water depth may change too quickly to allow time for you to react. Always operate the boat at very slow speeds if you suspect shallow water or submerged objects.

 **WARNING!** The electronic chart in your Humminbird unit is an aid to navigation designed to facilitate the use of authorized government charts, not to replace them. Only official government charts and notices to mariners contain all of the current information needed for the safety of navigation, and the captain is responsible for their prudent use.

 **WARNING!** Disassembly and repair of this electronic unit should only be performed by authorized service personnel. Any modification of the serial number or attempt to repair the original equipment or accessories by unauthorized individuals will void the warranty.

 **WARNING!** This product contains chemicals known to the State of California to cause cancer and birth defects or reproductive harm.

 **WARNING!** Humminbird is not responsible for the loss of data files (waypoints, routes, tracks, groups, recordings, etc.) that may occur due to direct or indirect damage to the unit's hardware or software. It is important to back up your control head's data files periodically. Data files should also be saved to your PC before restoring the unit's defaults or updating the software. See your Humminbird online account at humminbird.com, the Waypoint Management Guide, and your control head operations guide for details.

 **NOTE:** Some features discussed in this manual require a separate purchase, and some features are only available on international models. Every effort has been made to clearly identify those features. Please read the manual carefully in order to understand the full capabilities of your model.

 **NOTE:** The Ethernet accessory is compatible with many Humminbird models, and every effort has been made to note the differences between the models and functions throughout this manual. The illustrations in this manual may look different than your display, but your model will operate in a similar way.

 **NOTE:** To purchase accessories for your control head, visit our Web site at humminbird.com or contact Humminbird Customer Service at **1-800-633-1468**.

 **NOTE:** The procedures and features described in this manual are subject to change without notice. This manual was written in English and may have been translated to another language. Humminbird is not responsible for incorrect translations or discrepancies between documents.

 **NOTE:** Product specifications and features are subject to change without notice.

 **NOTE:** Humminbird verifies maximum stated depth in saltwater conditions, however actual depth performance may vary due to transducer installation, water type, thermal layers, bottom composition, and slope.

ROHS STATEMENT: Product designed and intended as a fixed installation or part of a system in a vessel may be considered beyond the scope of Directive 2002/95/EC of the European Parliament and of the Council of 27 January 2003 on the restriction of the use of certain hazardous substances in electrical and electronic equipment.

ATTENTION INTERNATIONAL CUSTOMERS: Products sold in the U.S. are not intended for use in the international market. Humminbird international units provide international features and are designed to meet country and regional regulations. Languages, maps, time zones, units of measurement, and warranty are examples of features that are customized for Humminbird international units purchased through our authorized international distributors.

To obtain a list of authorized international distributors, please visit our Web site at humminbird.com or contact Humminbird Customer Service at **(334) 687-6613**.

ENVIRONMENTAL COMPLIANCE STATEMENT: It is the intention of Johnson Outdoors Marine Electronics, Inc. to be a responsible corporate citizen, operating in compliance with known and applicable environmental regulations, and a good neighbor in the communities where we make or sell our products.

WEEE DIRECTIVE: EU Directive 2002/96/EC “Waste of Electrical and Electronic Equipment Directive [WEEE]” impacts most distributors, sellers, and manufacturers of consumer electronics in the European Union. The WEEE Directive requires the producer of consumer electronics to take responsibility for the management of waste from their products to achieve environmentally responsible disposal during the product life cycle.

WEEE compliance may not be required in your location for electrical & electronic equipment (EEE), nor may it be required for EEE designed and intended as fixed or temporary installation in transportation vehicles such as automobiles, aircraft, and boats. In some European Union member states, these vehicles are considered outside of the scope of the Directive, and EEE for those applications can be considered excluded from the WEEE Directive requirement.



This symbol [WEEE wheelie bin] on product indicates the product must not be disposed of with other household refuse. It must be disposed of and collected for recycling and recovery of waste EEE. Johnson Outdoors Marine Electronics, Inc. will mark all EEE products in accordance with the WEEE Directive. It is our goal to comply in the collection, treatment, recovery, and environmentally sound disposal of those products; however, these requirements do vary within European Union member states. For more information about where you should dispose of your waste equipment for recycling and recovery and/or your European Union member state requirements, please contact your dealer or distributor from which your product was purchased.

360 Imaging®, 700 Series™, 800 Series™, 900 Series™, 1100 Series™, Down Imaging®, DualBeam PLUS™, Fish ID+™, HELIX™, Humminbird®, InterLink™, RTS Window™, Side Imaging®, SwitchFire®, WhiteLine™, and X-Press™ Menu are trademarked by or registered trademarks of Johnson Outdoors Marine Electronics, Inc.

TABLE OF CONTENTS

Introduction	7
1. Install an Ethernet Connection	8
2. Power On	12
Ethernet Network Overview	13
Customize the Unit Name	14
Open the Network Source Setup Dialog Box	15
Sonar Source Overview	17
Set up Sonar	18
Select a Sonar Source	19
Change from a Lost Sonar Source	22
Temperature Source Overview	23
Select a Temperature Source	23
Change from a Lost Temperature Source	26
GPS Source and Sharing Waypoints Overview	28
Select a GPS Source	29
Change from a Lost GPS Source	30
Share Waypoints	31
Restore Defaults (Setup Menu Tab)	32
Troubleshooting	33
Fishing System Doesn't Power Up	33
Fishing System Defaults to Simulator with a Transducer Attached	33
Contact Humminbird	34

INTRODUCTION

This manual will guide you through the following network setup instructions:

- 1. Connect two Humminbird units together**
- 2. Power On**
- 3. Configure your Humminbird Ethernet Network**
- 4. Share Waypoints**

Alarms, navigation, sonar data, and the menu system are all affected by the Ethernet network settings. We encourage you to read this manual completely so that you may understand the full capabilities of your Humminbird Ethernet network.

1. INSTALL AN ETHERNET CONNECTION

If your Humminbird control head has a built-in Ethernet connector, the unit can be connected to the Ethernet network. When you connect the units together, data is shared between the two units.

Before you start, please note that the Ethernet network installation has the following requirements:

- **Update Software:** Your model may require a software update to enable Ethernet. Log in to your account at humminbird.com to download the latest software update. For assistance, contact Customer Service.
- **Install the control heads and sources** (GPS, transducers, temp/speed accessories, etc.) for your Fishing System. See the equipment installation guides for details.
- **Purchase Ethernet Connection Cables (separate purchase required):** Your network configuration and Ethernet port shape will determine which Humminbird connection cables you will need to purchase.

Purchase Ethernet Cables and Equipment

1. **Review the illustrations on the following pages.** Find your control head models and locate the Ethernet port on each control head.

The shape of the Ethernet port determines the cable(s) you need to purchase, as shown in the following table. The Ethernet port will be round or shaped like an hourglass.

Ethernet Cable Information	
Control Heads	Required Cables
[2] Units with Hourglass-shaped Ethernet Ports	[2] AS EC QDE & [1] AS EC [length]E
[1] Unit with an Hourglass-Shaped Port and [1] Unit with a Round Ethernet Port	[1] AS EC QDE & [1] AS EC [length]E
[2] Units with Round Ethernet Ports	[1] AS EC [length]E



NOTE: The AS EC [length]E cable is available in a variety of lengths. To purchase the Ethernet Cables and extension cables, visit our Web site at humminbird.com. To network more than two units, purchase the Humminbird AS ETH 5PXG.

1100ci Series HD Control Head with Hourglass-shaped Ethernet Port

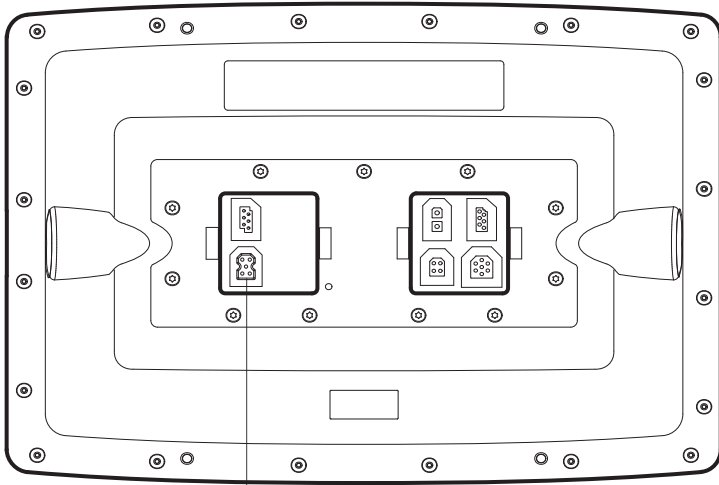

Ethernet port

1100c Series Control Head with Round Ethernet Port

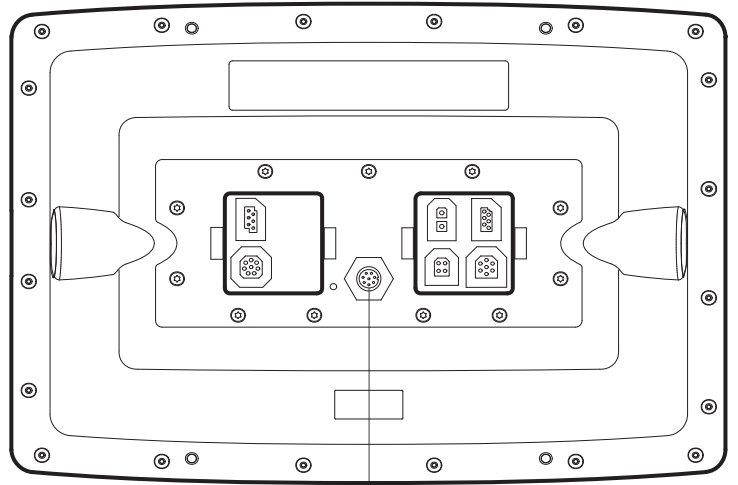

Ethernet port

800ci Series/900ci Series HD Control Head with Hourglass-shaped Ethernet Port

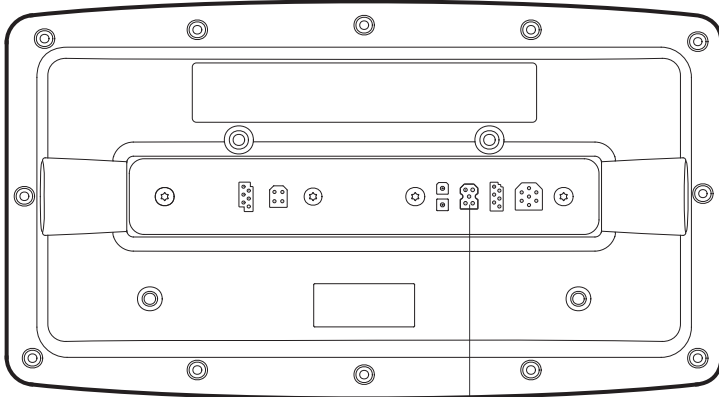

Ethernet port

800c Series/900c Series Control Head with Round Ethernet Port

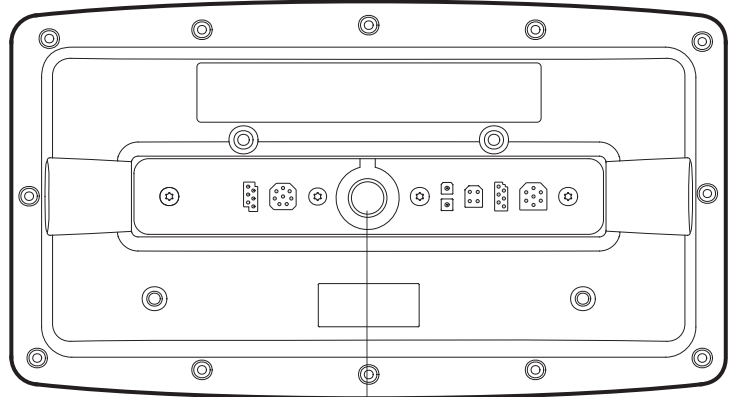

Ethernet port

700 Series HD Cable Collector with Hourglass-shaped Ethernet Port

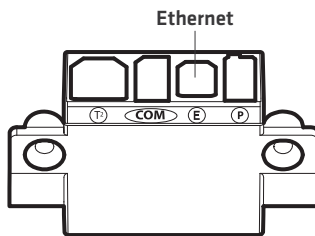

Ethernet

HELIX 9, 10, 12 [Cable Tray] with Hourglass-shaped Ethernet Port

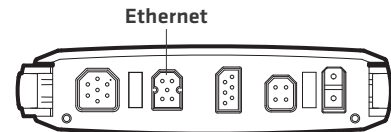

Ethernet

Connect the Control Heads

1. Confirm that the control heads are powered off.
2. Review the illustrations on the preceding pages. Find your control head models and locate the Ethernet port on each control head.
3. Connect the Ethernet cable[s] together and route them to each control head. Connect the Ethernet cable[s] to each Ethernet port, noting the following:
 - The connectors are keyed to prevent incorrect installation, so be careful not to force the connectors into the port.
 - On round cable connectors, hand-tighten the screw nut to secure the connection.
 - If the control head has a round Ethernet port, the Ethernet cable can be connected directly to the control head. If the control head has an hourglass-shaped port, it will connect to the unit through a cable collector or cable tray. Consult your control head installation guide for details.

CAUTION! Do NOT mount the cables where the connectors could be submerged in water or flooded. If cables are installed in a splash-prone area, it may be helpful to apply dielectric grease to the inside of the connectors to prevent corrosion. Dielectric grease can be purchased separately from a general hardware or automotive store.

HELIX 9, 10, 12 [Cable Tray] with Hourglass-shaped Ethernet Port

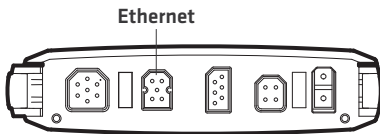

Connecting the Cable Tray to the Control Head [HELIX 9, 10, 12]

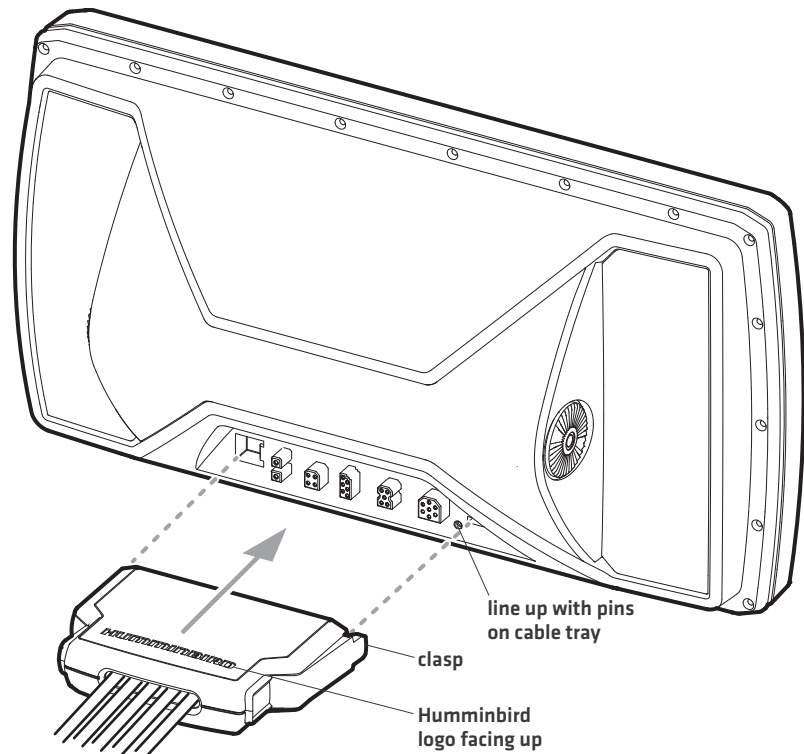

Connecting to a Round Ethernet Port

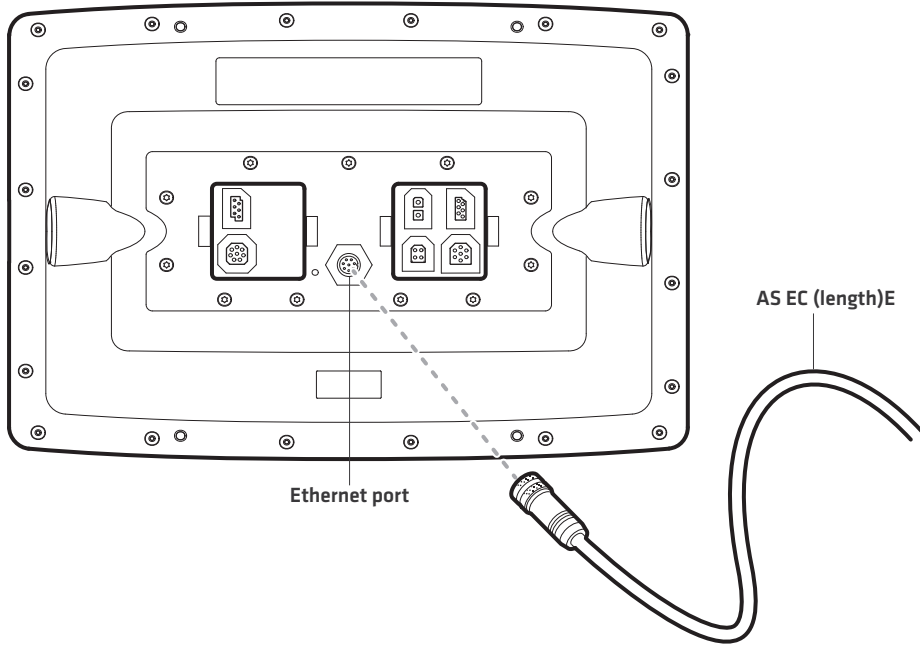

Hand-Tightening the Screw Nut

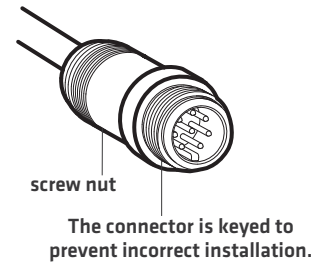

700 Series HD Quick Disconnect Mount Cable Collector

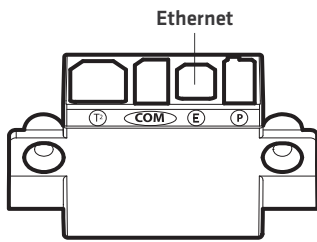

Connecting the Ethernet Cables to a 700 Series HD Unit

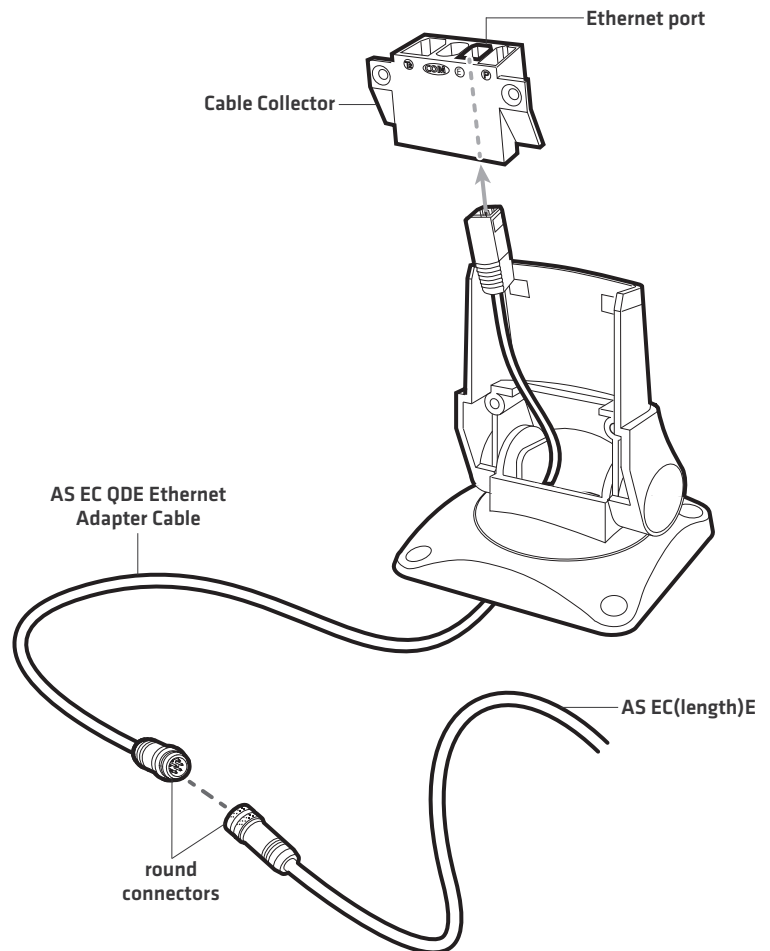

2. POWER ON

When you have installed an Ethernet network, the power on process is the same as powering on a single control head, however, your transducer connections will determine how the control head starts normal operation.

If there is a transducer connected to only one of the control heads, and you intend to share the transducer on the network, power on the control head with the connected transducer first.

Power On

1. If there is a transducer connected to only one of the control heads, power it on first. Press the  POWER/LIGHT key.
2. When you power on the control head, it will start Normal mode automatically if a functioning transducer is detected.
 - **If a transducer is not attached to the control head**, but there is another transducer connected to the network, press the MENU key when the Title screen is displayed. Select Normal from the Start-up Menu. [This step is only required for first-time setup or after defaults have been restored on the unit.]
 - **If you are prompted to select a sonar source at start up**, see *Select a Sonar Source* for more information.
3. Repeat steps 1 and 2 until all the control heads in the network are powered on.



NOTE: If you have an **InterLink** connected to the network, the Ethernet will disable the InterLink because both network systems cannot be used at the same time.

ETHERNET NETWORK OVERVIEW

When the Humminbird network is installed, each control head automatically selects a primary source [transducer, temperature, and GPS]. The control head selects the equipment connected to it as its primary source, but you can choose any compatible source on the network.

For example, if you have more than one GPS receiver installed on the network, whether internal or external, you can select one GPS receiver to be the shared source for all control heads on the network.

Local [default]: The source is connected directly to the control head, and it is only reporting data to that control head.

Shared: The source is set up to send data to both control heads in the network, so they share the same information.

It is important to note that when a source is shared on the network, the source's data will be synchronized between units. The Menu System and View Rotation will change to match the shared source's capabilities. Review each source section to understand how a shared source will affect your control head.

CHIRP Models: A CHIRP unit can use sources from any other control heads on the network. If a unit is not CHIRP-capable, it cannot use sources connected to the CHIRP control head [unless CHIRP mode is turned off]. See **Set up Sonar** for details.

Example of a Network Configuration

GPS (Shared)

Note that the Speed Digital Readout is the same on both control head views

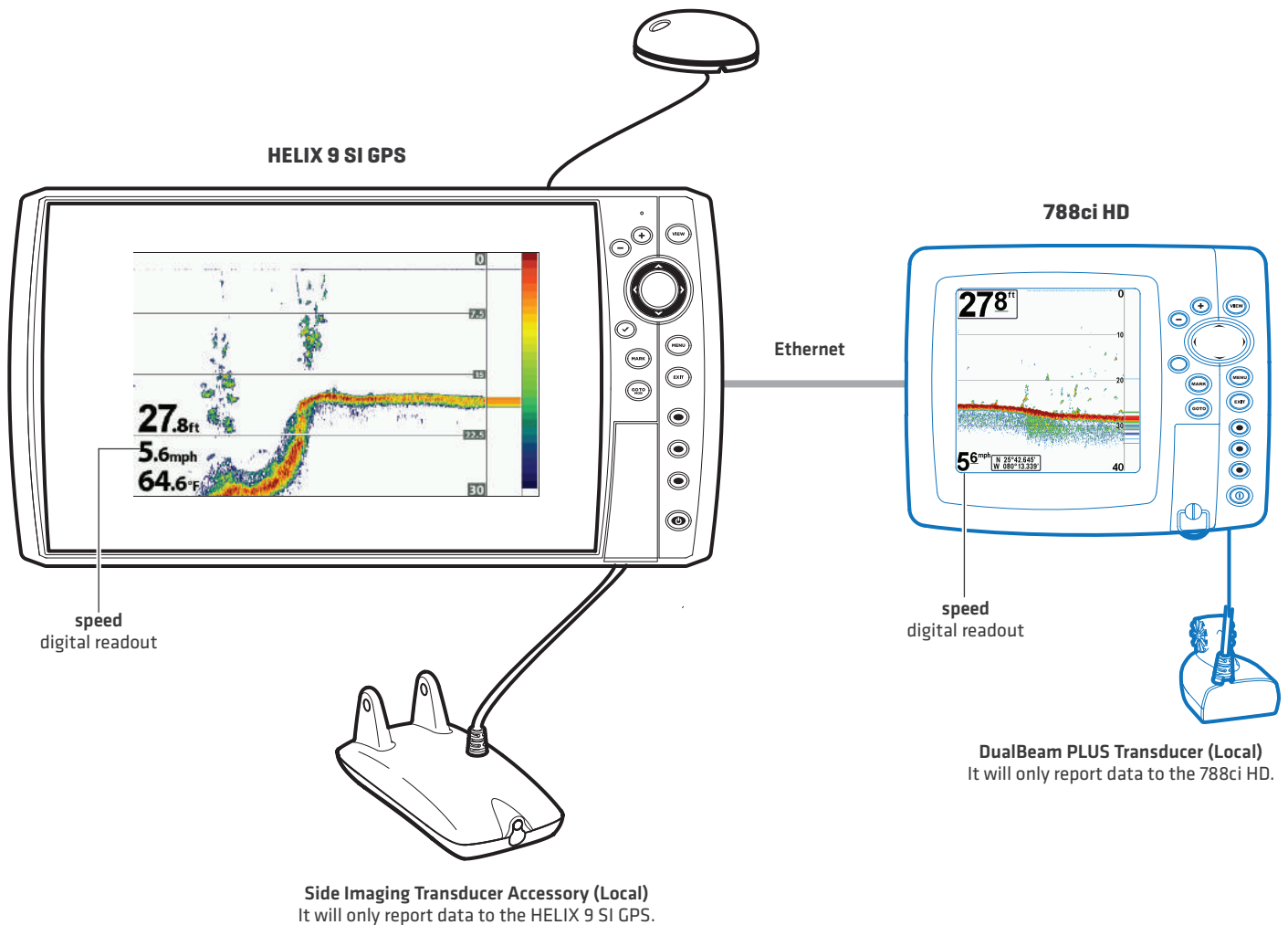

CUSTOMIZE THE UNIT NAME

Each control head is assigned a unit name, which is based on its model number and serial number. Use the following instructions to edit the unit name, so it is easier to identify each unit on the network.

1. **Main Menu:** Press the MENU key twice. Select the **Network** tab.
2. Select **Unit Name** [700, 800, 900, 1100 Series] or the **Name of the Unit** [HELIX models]. Press the RIGHT Cursor key.

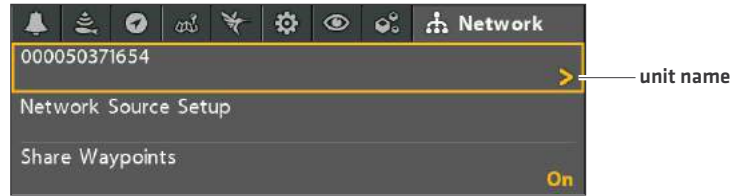

3. Use the Cursor Control key to edit the name.
4. Follow the on-screen prompts to save your changes.

Changing the Unit Name

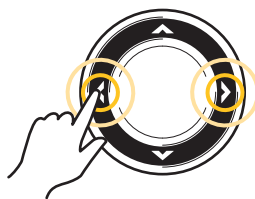

Move from Space to Space

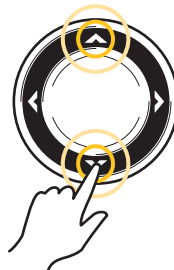

Select a Letter, Number, or Symbol



Save

OPEN THE NETWORK SOURCE SETUP DIALOG BOX

The Network Source Setup dialog box displays all the sources connected to the network. The sources may be shared on the network or operating locally with their connected control head.

Open the Network Source Setup Dialog Box

1. **Main Menu:** Press the MENU key twice. Select the **Network** tab.
2. Select Network Source Setup. Press the RIGHT Cursor key.

Status Tab: Review the status tab to see all detected sources in the network. If a source is grayed out, the source is detected, but the connection is lost or unavailable.

Select a Source: Review each source section in this manual to select a data source for each control head and understand how a shared source will affect your control head.

CHIRP Models: A CHIRP unit can use sources from any other control heads on the network. If a unit is not CHIRP-capable, it cannot use sources connected to the CHIRP control head [unless CHIRP Mode is turned off]. See **Set up Sonar** for details.

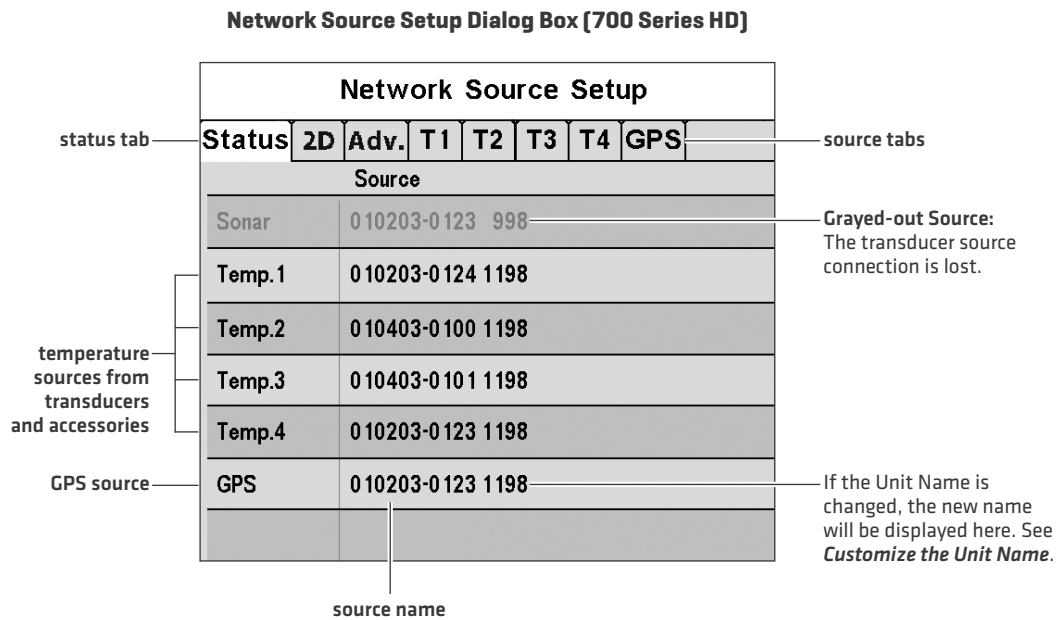

Network Source Setup Dialog Box (HELIX Series)

Network Source Setup

status tab — **Status** 2D Adv. T1 T2 T3 GPS — source tabs

Source	Name
Sonar	
360	
Temp.1	000050371654 Transducer
Temp.2	000050371654 Transducer
Temp.3	000050371654 Transducer
Temp.4	
GPS	000050371654

sonar sources —

temperature sources from transducers and accessories —

GPS source —

source name —

Grayed-out Source: The transducer source connection is lost.

If the Unit Name is changed, the new name will be displayed here. See *Customize the Unit Name.*

SONAR SOURCE OVERVIEW

When you select a new transducer source, the alarms, menu settings, view rotation, and digital readouts will update automatically on the control head.

- **Menu Settings:** If the sonar source is shared, the control heads will synchronize menu settings [Shared], while other menu settings will continue to operate individually [Local] on each control head. When you change a shared menu setting on one control head, it will be updated on the other control heads that are sharing the source.
- **Views:** The view rotation will update to display views that are compatible with the selected transducer.
- **Alarms:** When Sonar sources are shared on the network, the alarms are also shared. The shared alarm settings can be controlled from either control head, and the alarms will display or sound on both control heads. **To turn off a shared alarm**, press the EXIT key on any control head.

Shared Sonar Menu Settings		
Beam Select	Lower Range	SI Range
Depth Alarm	Max Depth	SwitchFire
Depth Offset	Noise Filter	Water Type
Fish ID+	Ping Rate	Units - Depth
Fish ID Sensitivity		

Local Sonar Menu Settings		
83 kHz Sensitivity	Quad Layout	Sonar Colors
455 kHz Sensitivity	RTS Window	Ping Rate
Bottom Lock	Sensitivity [Down]	SI Range
Bottom Range	SI Colors	SwitchFire
Bottom View	SI Enhance	Transducer Select
Chart Speed	SI Sensitivity	Upper Range
Depth Lines	SI Side	Water Type



NOTE: The Shared and Local menu options may change to accommodate new product features.

Set up Sonar

Use the instructions below to select sonar sources for each control head. Before you can select frequencies from the network, the control heads must be set up with their connected transducer.

1. Set up the Transducer

The following instructions are only required the first time you set up each control head with an attached transducer.

1. **Main Menu:** Press the Menu key twice.
2. Select the Sonar tab > Connected Transducer [or Transducer Select].
3. Press the Right or Left Cursor keys to scroll through the compatible transducers for that model. Select the transducer that is attached to the control head.
4. Repeat steps 1 to 3 for each control head.

If there is not a transducer attached to a control head, you can skip this section for that control head.

2. Turn on/off CHIRP Mode

A CHIRP unit can use sources from any other control head on the network. If a unit is not CHIRP-capable, it cannot use sources connected to the CHIRP control head [unless CHIRP Mode is turned off].

1. **Main Menu:** Press the Menu key twice.
2. Select the Sonar tab > CHIRP Mode.
3. Select on or off.

In the following example, the HELIX 9 SI GPS Network Source Setup dialog box shows the HELIX 12 CHIRP SI GPS transducer is listed, but it is grayed out to show it cannot be used by the HELIX 9 [because the HELIX 9 it is not CHIRP-capable]. However, the sonar source on the CHIRP unit will be available to the HELIX 9 if you turn off CHIRP mode on the HELIX 12.

Network Source Setup Dialog Box (HELIX 9 SI GPS)

Network Source Setup					
Status	2D	Adv.	T1	T2	GPS
Name	Model				
000071147184	HELIX 9 SI GPS	High Definition Side Imaging			83/200 kHz <input checked="" type="checkbox"/>
xy0050371654	HELIX 12 CHIRP SI GPS	High Definition Side Imaging			83/200 kHz <input type="checkbox"/>

sonar sources

grayed-out source

Select a Sonar Source

When you first set up the network, the control head will automatically choose the transducer connected to it. Use the Network Source Setup dialog box to change the sonar source.

The transducer you select on the 2D tab will provide the data for the 2D Sonar Views and related digital readouts.

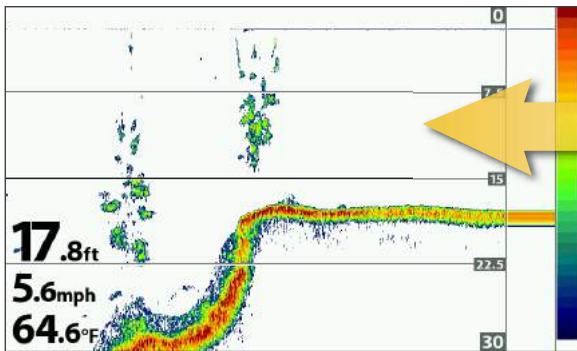

2D Sonar View Readouts:
 17.8ft
 5.6mph
 64.6°F

Network Source Setup							
Status	2D	Adv.	360	T1	T2	T3	GPS
Name	Model						
000033391693		HELIX 9 DI GPS		DI 200/455 kHz			200/455 kHz <input checked="" type="checkbox"/>
000145251715		HELIX 10 DI GPS		DI 200/455 kHz			200/455 kHz <input type="checkbox"/>

If you select a Down Imaging transducer on the Adv. tab, it will provide the data for the Down Imaging Views and related digital readouts.

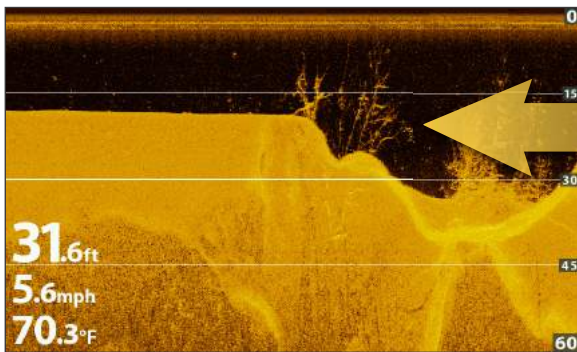

Down Imaging Sonar View Readouts:
 31.6ft
 5.6mph
 70.3°F

Network Source Setup							
Status	2D	Adv.	360	T1	T2	T3	GPS
Name	Model						
000033391693		HELIX 9 DI GPS		DI 200/455 kHz			455/800 <input checked="" type="checkbox"/>
000039114206		HELIX 12 CHIRP SI GPS		High Definition Side Imaging			455/800 <input type="checkbox"/>
000145251715		HELIX 10 DI GPS		DI 200/455 kHz			455/800 <input type="checkbox"/>
8E29		AS 360		AS 360			455 <input type="checkbox"/>

If you select a Side Imaging transducer on the Adv. tab, it will provide the data for the Side Imaging Views and related digital readouts.



Side Imaging Sonar View Readouts:
 31.7ft
 5.6mph
 58.5°F

Network Source Setup							
Status	2D	Adv.	360	T1	T2	T3	GPS
Name	Model						
000033391693		HELIX 9 DI GPS		DI 200/455 kHz			455/800 <input type="checkbox"/>
000039114206		HELIX 12 CHIRP SI GPS		High Definition Side Imaging			455/800 <input checked="" type="checkbox"/>
000145251715		HELIX 10 DI GPS		DI 200/455 kHz			455/800 <input type="checkbox"/>
8E29		AS 360		AS 360			455 <input type="checkbox"/>

As you select sonar sources for each view, it is important to consider the following information:

Default: When you first set up the network, the control head will automatically choose the transducer source connected to it. You can use the default settings, or you can select which transducer you want to use.

Compatibility: If your 700, 800, 900, or 1100 Series model number ends in 8, your control head must be compatible with the transducer you select on the network to use it as a sonar source. All other models can select any other transducer from the network as a sonar source. However, if a model is not CHIRP-capable, it cannot network with other CHIRP units unless CHIRP Mode is turned off on the CHIRP unit. See **Set up Sonar** for details.

Down Imaging Units: If you select a Down Imaging transducer on the network, you must choose the 2D beams [2D tab] and the Down Imaging beams [Adv. tab] from the same Down Imaging transducer. The beams cannot be split in this scenario.

Accessories: If you have installed an accessory transducer, and it is not displayed in the transducer list, see **Set up Sonar**.

Select Sonar Sources

1. Open the Network Source Setup dialog box.
2. Select the 2D tab.

The 2D tab lists the beams available for the 2D Sonar Views.

3. **Select:** Press the DOWN or UP Cursor keys to choose a source.
4. Press the RIGHT Cursor key or the CHECK/INFO key to select it [check mark = selected].
5. Select the Adv. tab, and repeat steps 3 and 4.

The Advanced tab lists the Side Imaging and Down Imaging beams available for the Side Imaging and Down Imaging Views.

6. **Save:** Press the EXIT key twice to close the dialog box. Network settings are saved even after the unit is powered off.
7. Repeat the steps in this section on each control head to choose a sonar source.

Local Setup (default): To use separate transducers for each control head, repeat these steps on each control head until you've set a transducer for each unit.

Shared Setup: To use the same transducer with more than one control head, repeat these steps on each control head and select the same transducer for all units.



NOTE: It is not recommended to ping two transducers of the same frequency at the same time.

Selecting Beams for the Side Imaging View (HELIX Series)

Network Source Setup							
Status	2D	Adv.	T1	T2	T3	GPS	
Name		Model					
000050371654		HELIX 12 CHIRP SI GPS	High Definition Side Imaging			455/800	<input checked="" type="checkbox"/>
000071147184		HELIX 9 SI GPS	High Definition Side Imaging			455/800	<input type="checkbox"/>

available sonar sources



Scroll through the List

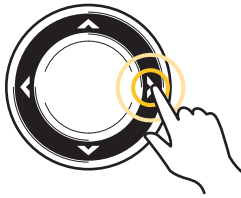

Select

OR



Select

Change from a Lost Sonar Source

If the control head cannot detect the selected transducer, follow the on-screen prompts to switch to another transducer in the network. If you switch to a Local source, you are selecting the transducer connected directly to the control head.

Changing the Sonar Source (700 Series HD)

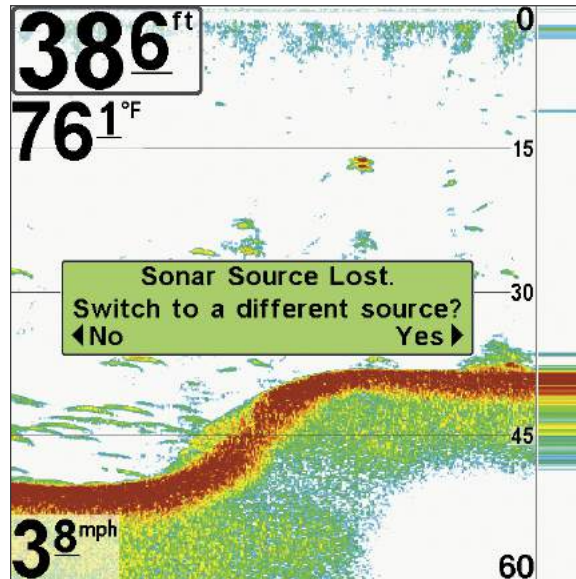

Changing the Sonar Source (HELIX Series)

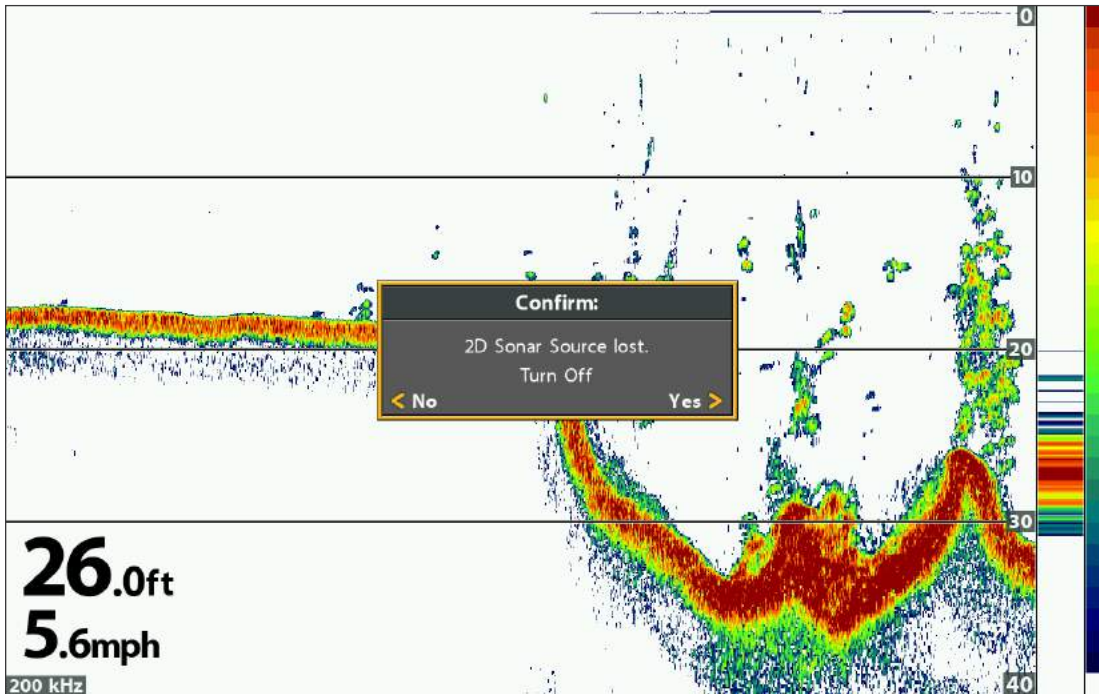

TEMPERATURE SOURCE OVERVIEW

When you select a new temperature source, the alarms, menu settings, view rotation, and digital readouts will automatically update on the control head.

- **Menu Settings:** If the temperature source is shared, the control heads will synchronize menu settings [Shared], while other menu settings will continue to operate individually [Local] on each control head. When you change a shared menu setting on one control head, it will be updated on the other control heads that are sharing the source.
- **Views:** The view rotation will update to display views or digital readouts that are compatible with the selected temperature source.
- **Alarms:** When temperature sources are shared on the network, the alarms are also shared. The shared alarm settings can be controlled from either control head, and the alarms will display or sound on both control heads. **To turn off a shared alarm**, press the EXIT key on each control head.

Shared Temperature Menu Settings		
Temp. Alarm	Units - Temp	Aux. Temp Alarm

 **NOTE:** The remaining temperature menu options are controlled locally. The Shared and Local menu options may change to accommodate new product features.

Select a Temperature Source

Temperature sources can be detected from a transducer’s built-in temperature feature or from optional-purchase temperature/speed accessories connected to the network.

- **Default:** When you first set up the network, the control head will automatically choose the temperature source connected to it.
- **Temperature Tabs:** The T1, T2, T3, and T4 tabs at the top of the Network Source Setup dialog box represent the digital readout positions on the screen. You can choose a different temperature source for each digital readout box, so each control head can display up to four temperature digital readouts on the display.

 **NOTE:** There will be less than four temperature tabs displayed if there aren’t four temperature sources connected to the network.

Temperature Readout Sources

Press the
RIGHT or LEFT
Cursor key
to select a tab.

Network Source Setup							
Status	2D	Adv.	Temp. 1	T2	T3	T4	GPS
Name		Model	Source				
	010203-0123	1198c SI	Auxiliary Temp.				<input checked="" type="checkbox"/>
	010203-0123	1198c SI	Transducer				<input type="checkbox"/>
	010203-0124	1198c SI	Auxiliary Temp.				<input type="checkbox"/>
	010203-0124	1198c SI	Transducer				<input type="checkbox"/>
	010403-0100	1198c SI	Auxiliary Temp.				<input type="checkbox"/>
	010403-0100	1198c SI	Transducer				<input type="checkbox"/>
	010403-0101	1198c SI	Auxiliary Temp.				<input type="checkbox"/>
	010403-0101	1198c SI	Transducer				<input type="checkbox"/>

temperature tabs

available
temperature sources

The Temperature Source tabs correspond with the digital readout positions on the screen.

Temperature Digital Readouts (1100 Series)

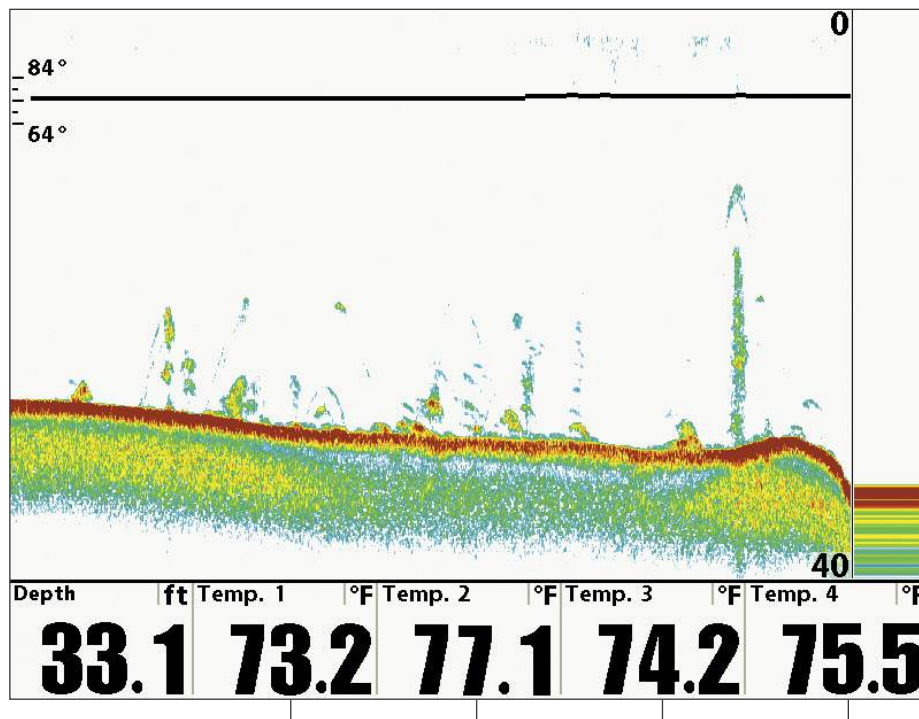

The Temperature Digital Readout positions correspond with the T1, T2, T3, and T4 tabs in the Network Source Setup dialog box.

Select Temperature Sources

1. Open the Network Source Setup dialog box.
2. Select the tab for T1, T2, T3, or T4. Each tab represents a digital readout position on the screen.



NOTE: The temperature readout positions may vary with the Humminbird model. See the Views section and Select Readouts section of your Humminbird Operations Manual for more information.

3. **Select:** Press the DOWN or UP Cursor keys to choose a source.
4. Press the RIGHT Cursor key or the CHECK/INFO key to select it [check mark = selected].
5. Repeat steps 2 through 4 to select a different temperature tab.
6. **Save:** Press the EXIT key twice to close the dialog box. Network settings are saved even after the unit is powered off.
7. Repeat the steps in this section on each control head to choose a temperature source for each tab. You can select the same source or a different source.

Local Setup: To use separate temperature sources for each control head, repeat these steps on each control head until you've set a temperature source for each unit and each digital readout.

Shared Setup: To use the same temperature sources on more than one control head, repeat these steps on each control head and select the same temperature sources on all units.

Selecting a Temperature Source for Digital Readout Position 1

Temp 1 tab sets the temperature source for digital readout 1 on the screen.

The control head detects all the temperature sources in the network.

Network Source Setup							
Status	2D	Adv.	Temp. 1	T2	T3	T4	GPS
Name	Model	Source					
010203-0123	1198c SI	Auxiliary Temp.	<input checked="" type="checkbox"/>				
010203-0123	1198c SI	Transducer	<input type="checkbox"/>				
010203-0124	1198c SI	Auxiliary Temp.	<input type="checkbox"/>				
010203-0124	1198c SI	Transducer	<input type="checkbox"/>				
010403-0100	1198c SI	Auxiliary Temp.	<input type="checkbox"/>				
010403-0100	1198c SI	Transducer	<input type="checkbox"/>				
010403-0101	1198c SI	Auxiliary Temp.	<input type="checkbox"/>				
010403-0101	1198c SI	Transducer	<input type="checkbox"/>				

selected

unit name column (see *Customize the Unit Name*)

unit model number column

temperature source type column (from transducers or accessories)

Temperature Graph (1100 Series)

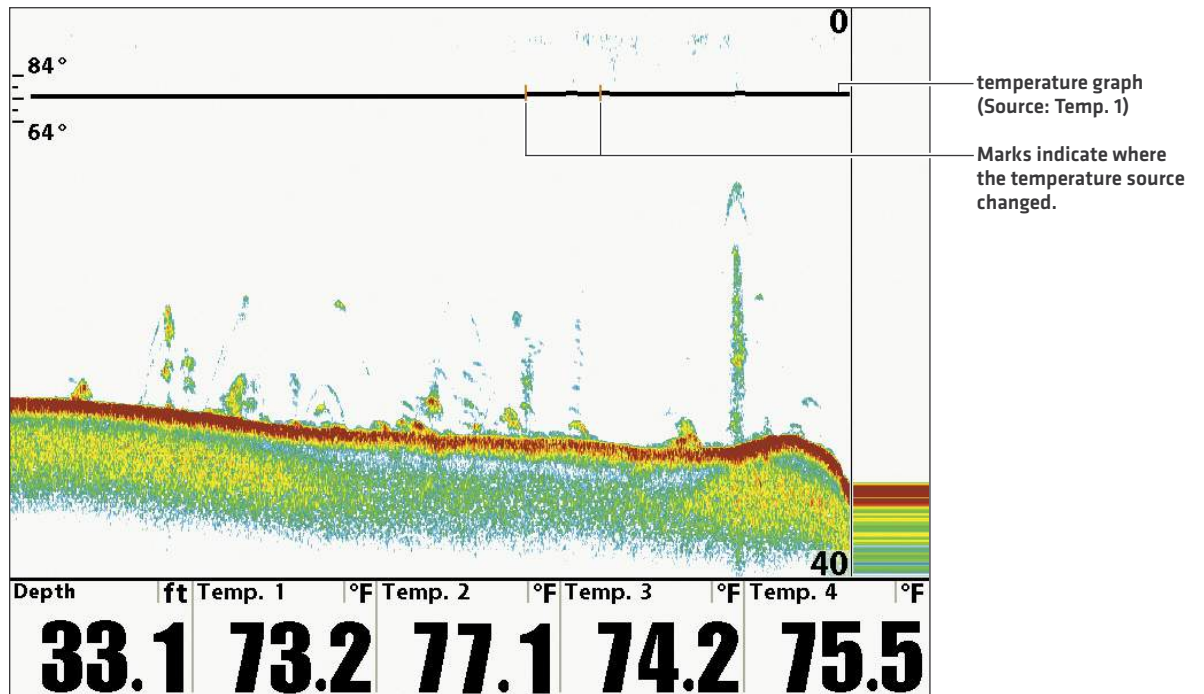

Change from a Lost Temperature Source

To change the temperature source after the network has been configured, open the Network Source Setup dialog box to change the temperature sources at any time [see *Select a Temperature Source*]. Network settings are saved even after the unit is powered off.

- **Temperature Graph [1100 Series, HELIX Series]:** Temperature Source 1 provides the data for the temperature graph on the display. When the temperature source is changed, the temperature graph displays a red mark to show where the temperature source was changed.



NOTE: The Temperature Graph menu setting is not shared on the network. It is a local menu setting.

- **If the control head cannot detect the set temperature source,** the digital readout box will flash. If the digital readout box is blank, the source has been lost. Open the Network Source Setup dialog box to assign a temperature source to the digital readout box. See *Select a Temperature Source* for details.

Temperature Source Lost (1100 Series)

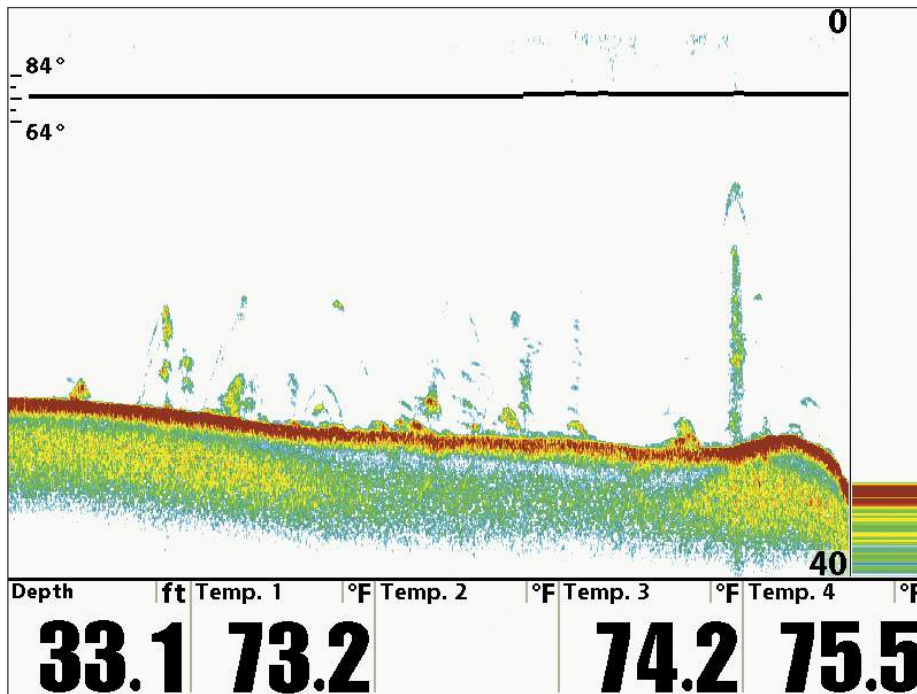

The Temp 2 (T2) Source is not detected on the network.

Temperature Source Lost (HELIX Series)

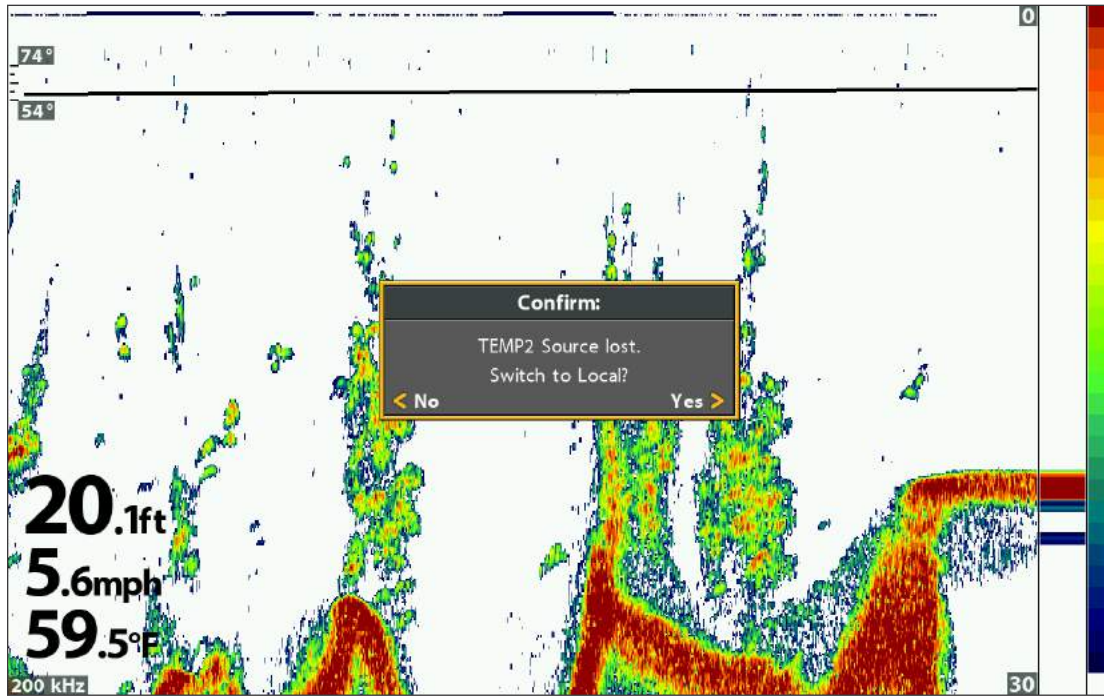

If you switch to a Local source, you are selecting the transducer or temperature accessory connected directly to the control head.

GPS SOURCE AND SHARING WAYPOINTS OVERVIEW

When you select a new GPS source, the position, menu settings, view rotation, and digital readouts will automatically update on the control head. To view waypoint data on the network, it is important to understand the GPS source and how to share waypoint data.

- **Menu Settings:** If the GPS source is shared, the control heads will synchronize menu settings [Shared], while other menu settings will continue to operate individually [Local] on each control head. When you change a shared menu setting on one control head, it will be updated on the other control heads that are sharing the GPS source.
- **Views:** The view rotation will update to correspond with the GPS receiver. If a networked control head is not a chartplotter, it will display chart information in trackplotter format [if it is trackplotter-capable].
- **Navigation:** Waypoint data can be shared, and you can build a route on either control head with the shared waypoints. See **Share Waypoints** for more information.

Select a GPS Source

When you power on the network for the first time, the control head will automatically choose the connected or internal GPS receiver to provide data to the control head. Use the instructions below to change the GPS source for the selected control head.

Select a GPS Source

1. Open the Network Source Setup dialog box.
2. Select the GPS Tab.
3. **Select:** Press the DOWN or UP Cursor keys to choose a source.
4. Press the RIGHT Cursor key or the CHECK/INFO key to select it [check mark = selected].
5. **Save:** Press the EXIT key twice to close the dialog box. Network settings are saved even after the unit is powered off.
6. Repeat the steps in this section on each control head to choose a GPS source for each tab. You can select the same source or a different source.

Local Setup: To use separate GPS receivers for each control head, repeat these steps on each control head until you've set a GPS receiver for each unit.

Shared Setup: To use the same GPS receiver with more than one control head, repeat these steps on each control head and select the same GPS receiver on all units.

Selecting a GPS Source

Network Source Setup

Status	2D	Adv.	T1	T2	T3	T4	GPS
Name	Model	Type	Fix				
010203-0123	1198c SI	Ext.	Enhanced	<input type="checkbox"/>			
010203-0123	1198c SI	Int.	Enhanced	<input type="checkbox"/>			
010203-0124	1198c SI	External	None	<input type="checkbox"/>			
010203-0124	1198c SI	Int.	None	<input checked="" type="checkbox"/>			
010403-0100	1198c SI	Ext.	Enhanced	<input type="checkbox"/>			
010403-0100	1198c SI	Int	Enhanced	<input type="checkbox"/>			
010403-0101	1198c SI	Ext.	None	<input type="checkbox"/>			
010403-0101	1198c SI	Int	Enhanced	<input type="checkbox"/>			

GPS tab

selected

The control head detects all GPS sources in the network.

unit name column (see <i>Customize the Unit Name</i>)	unit model number column	GPS type column (internal or external)	GPS Fix column
---	--------------------------	---	----------------



NOTE: The current GPS Fix is reported as No Fix, Fixed, or Enhanced. An Enhanced Fix has been augmented using information from WAAS, EGNOS, or MSAS. An Enhanced Fix is required for navigation.

Change from a Lost GPS Source

If the control head cannot detect the set GPS receiver, the control head will display an error message so that you can reset the GPS source as follows:

- If the shared GPS receiver is not detected, the control head will switch automatically to the local GPS receiver (internal or connected to the control head). Follow the on-screen instructions to save the local GPS receiver as the selected source.
- If the local GPS receiver is not detected, the GPS data will flash. If there isn't data displayed in the digital readout box, the source has been lost. See *Select a GPS Source* to select another GPS receiver in the network.

Finding the GPS Source (700 Series HD)

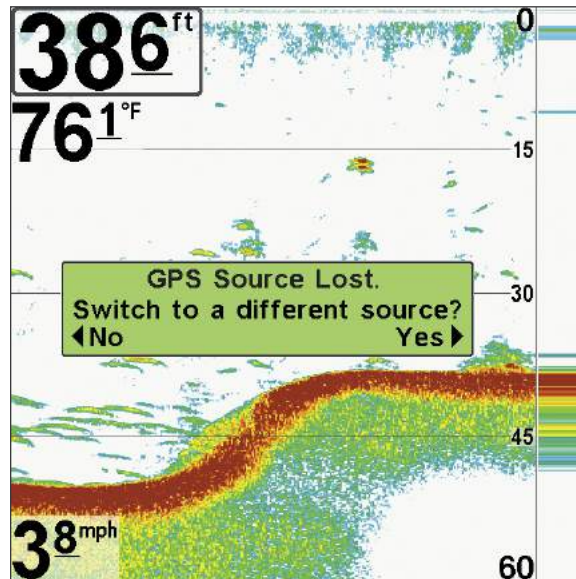

GPS Source Lost (HELIX Series)

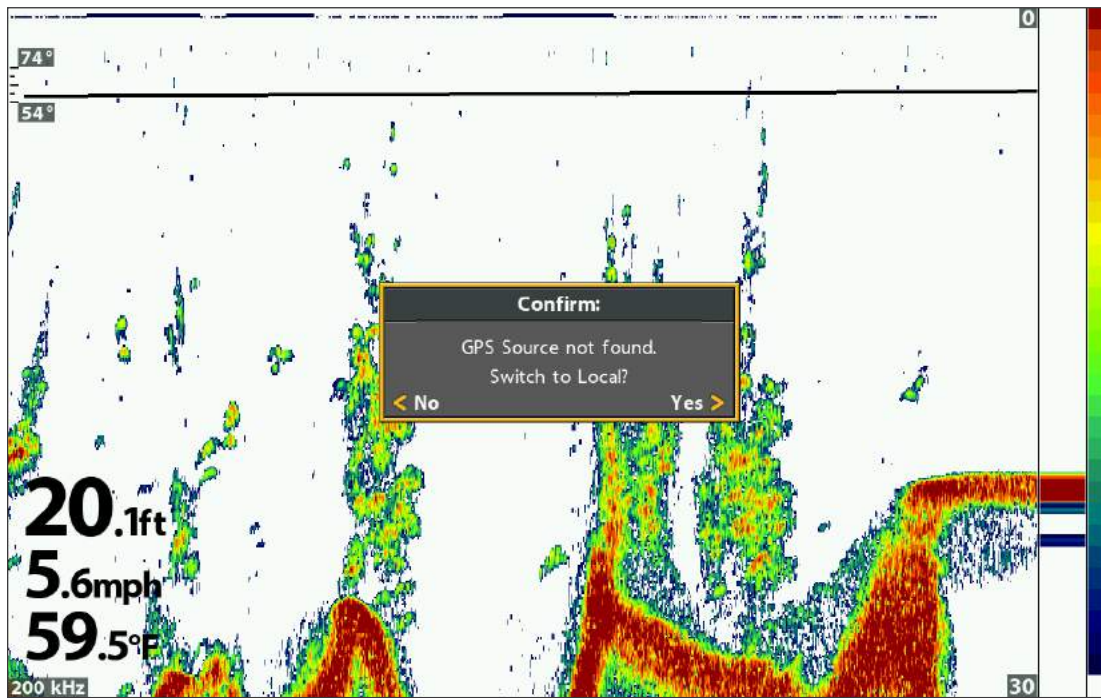

If you switch to a Local source, you are selecting the internal GPS.

Share Waypoints

To share waypoints on the network, **turn on Share Waypoints on each control head**. You can then observe the following:

- When a **waypoint** is marked on one control head, the waypoint will also be displayed on the other control head. If the waypoint is saved, it will be saved to the local control head where it was marked.
- **Routes:** When waypoints are viewed on both control heads, you can build a route from either control head using the shared waypoints. The route is saved to the control head where it was created.



NOTE: When the units are powered off, the waypoint data is saved only on its local control head where it was originally marked.

Routes and tracks are not shared on the network.



NOTE: Although the navigation data is viewable, it is not copied on every control head. In other words, a new route will be saved to the control head where the route was initiated. If you edit navigation data, the data will be saved back to its local control head.

Share Waypoints

1. **Main Menu:** Press the MENU key twice. Select the **Network** tab.
2. Select Share Waypoints. Press the RIGHT Cursor key to select On. [On, Off; Default = Off].
3. Repeat steps 1 and 2 on each control head so that each control head is sharing [or broadcasting] its waypoint data on the network.



NOTE: The remaining navigation menu options are controlled locally. The Shared and Local menu options may change to accommodate new product features.

If you choose to restore defaults on a Humminbird control head, it is important to note that the menu settings, including your saved network settings, will be reset to their factory defaults. See your Humminbird control head operations manual for more information.



CAUTION! Use this menu with caution!

1. **Main Menu:** Press the MENU key twice. Select the **Setup** tab.
2. Select Restore Defaults.
3. Press the RIGHT Cursor key.
4. Follow the on-screen prompts to confirm the reset.

TROUBLESHOOTING

Before contacting Humminbird Customer Service, please read the following section. Taking the time to review these troubleshooting guidelines may allow you to solve a performance problem yourself, and therefore avoid sending your unit back for repair.

Fishing System Doesn't Power Up

If your Fishing System doesn't power up, use the installation guide that is included with your Fishing System to confirm specific details, making sure that:

- the power cable is properly connected to the Fishing System control head,
- the power cable is wired correctly, with red to positive battery terminal and black to negative terminal or ground,
- the fuse is operational, and
- the battery voltage of the power connector is at least 10 Volts.

Correct any known problems, including removing corrosion from the battery terminals or wiring, or actually replacing the battery if necessary.

Fishing System Defaults to Simulator with a Transducer Attached

A connected and functioning transducer will cause the newly-started Fishing System to go into Normal operating mode automatically. If, when you power up the Fishing System, it goes into Simulator mode automatically, even though a transducer is already connected, this means that the control head is not detecting the transducer. Perform the following troubleshooting tasks:

- Using the Installation Guide that also comes with your Fishing System, check to make sure that the transducer cable is securely connected to the Fishing System. Reconnect if necessary, and power up the Fishing System again to see if this fixes the problem.
- Replace the non-functioning transducer with a known good transducer if available and power up the control head again.
- Check the transducer cable. Replace the transducer if the cable is damaged or corroded.

CONTACT HUMMINBIRD

Contact Humminbird Customer Service in any of the following ways:

Web site:

humminbird.com

E-mail:

service@humminbird.com

Telephone:

1-800-633-1468

Direct Shipping:

Humminbird
Service Department
678 Humminbird Lane
Eufaula, AL 36027 USA

Hours of Operation:

Monday - Friday

8:00 a.m. to 4:30 p.m. [Central Standard Time]

Social Media Resources:



[Facebook.com/HumminbirdElectronics](https://www.facebook.com/HumminbirdElectronics)



[Twitter.com \[@humminbirdfish\]](https://twitter.com/@humminbirdfish)



[YouTube.com/humminbirdtv](https://www.youtube.com/humminbirdtv)

