



BayMax Cat Litter Box

SCOOPER SE User Manual



Toll free: +1 833 440 2772 Email: support@catlink.cn

Thank you for purchasing the CATLINK BayMax Cat Litter Box - SCOOPER SE!

As a company, CATLINK is committed to developing innovative products that cater to your pet's needs and make your life easier. This user manual has been designed to help you get the most out of your SCOOPER SE, with detailed instructions for setting it up and helpful tips and advice for optimal usage.

The SCOOPER SE offers a variety of features that make it an indispensable addition to your home. To ensure you can fully explore and utilize these features, we recommend keeping this manual within easy reach for future reference. In case you require further assistance or have any queries, please feel free to email us at support@catlink.cn or call us at +1 833 440 2772.

We hope you and your pets enjoy the freedom that comes with the CATLINK BayMax Cat Litter Box - SCOOPER SE!

Thank you again for choosing CATLINK.

Important Safety Instructions

- ① Always be sure any cat in your household that might use the SCOOPER SE weighs at least 3.3 lbs. Cats must weigh 3.3 to 22 lbs to safely use the SCOOPER SE.
- ② Always place the SCOOPER SE on a firm, level surface. Avoid soft, uneven, or unstable flooring, which may affect the ability of the Unit to detect your cat.
- ③ Always unplug the Unit before servicing.
- ④ Never force your cat into the SCOOPER SE.
- ⑤ Never put anything in the Unit other than clumping litter or litter beads that are small enough to pass through the screen.
- ⑥ Never sit on or place anything on top of the SCOOPER SE.
- ⑦ Never push the SCOOPER SE against a wall or into a corner (must not be touching any walls).
- ⑧ Never remove the Globe or Cover while the Unit is rotating or turn the Unit on if the Globe or Cover is removed.
- ⑨ Never wet or submerge the Cover or Base.
- ⑩ Never allow children and people with reduced physical, sensory, or mental capabilities or lack of experience and knowledge to use, clean, or maintain the SCOOPER SE without supervision, instruction concerning its use in a safe way, and understanding of the hazards involved. Children under 8 years of age should not be allowed contact with the SCOOPER SE.
- ⑪ Never allow children or others to play with the SCOOPER SE.
- ⑫ Never use an external power supply other than the one provided with the Unit. Only use the power supply provided with the Unit. If it is damaged, contact us for a replacement.

Table of Contents

① Packing List	1	④ Clean Modes	8
② Product Structure	2	⑤ Button Functions	8
③ Setting Up Your SCOOPER SE	3	⑥ Indicator	9
1. Check the Items	3	⑦ How to Empty	10
2. Check Installation	3	⑧ Move the Unit	11
3. Placement	3	⑨ How to Clean	11
4. Check the Trash Liner	4	⑩ Safety Protection System	12
5. Power On and Test Cycle	4	⑪ Troubleshooting	12
6. Wi-Fi Connection	5	⑫ Product Specifications	14
7. Cat Litter	6	⑬ Customer Service	15
8. Activate and Place Deodorization Hydrogel	7		

01 Packing List

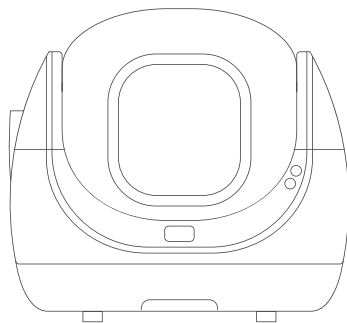

SCOOPER SE x1

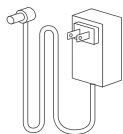

Power Adapter x1



Trash Liner x1

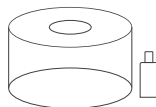

Deodorization
Hydrogel x1



User Manual

02 Product Structure

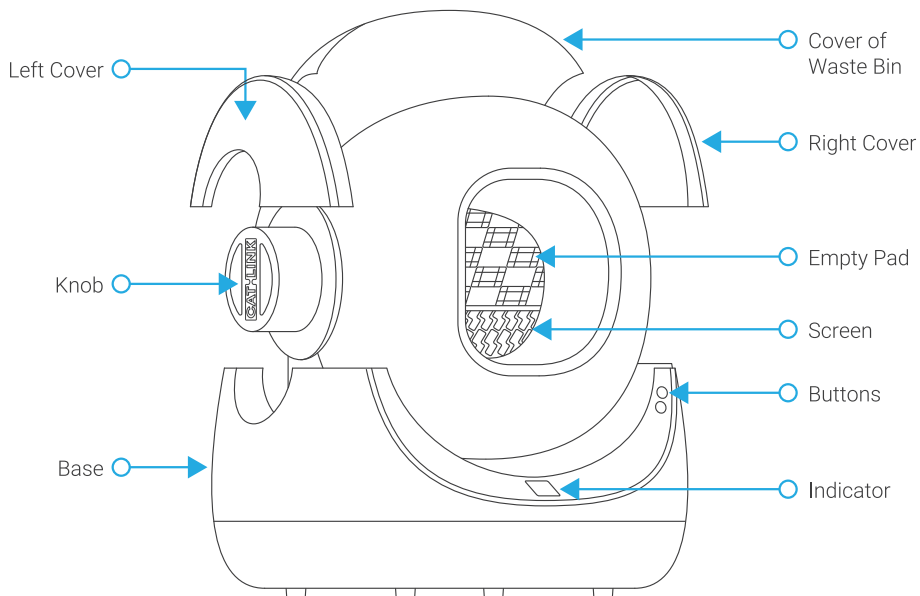

03 Setting Up Your SCOOPER SE

Once you have assembled the item and confirmed that the package is complete, get started by following the steps below.

- 1 Check the items:** Confirm that the item and accessories are present.
- 2 Check the installation:** Ensure that all items are installed correctly to avoid any issues.

(1) Make sure that the Trigger under the Right Cover is firmly locked in place.

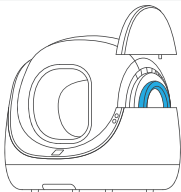

(2) Confirm that both Covers are properly installed and free from warping.

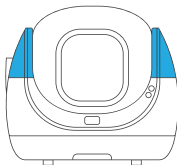

(3) Make sure that the Knob is set to the Clean position and that the Screen is not covered by the Empty Pad used for emptying litter.



- 3 Placement:** Place the Unit as required.

(1) Make sure that the Unit is placed on a level and sturdy surface with no objects beneath it. Soft, uneven, or unstable flooring should be avoided.

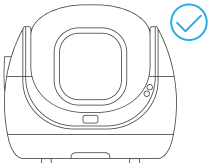

(2) Locate the Unit near a power outlet, with no walls or corners touching it, and nothing on top of it.

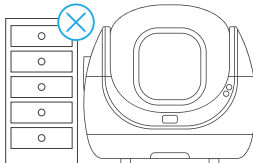

(3) Place the Unit close to a stable WiFi signal and far from devices that may cause WiFi interference.

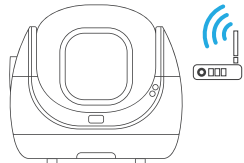

- 4 Check the Trash Liner:** Check that the Trash Liner is properly fitted and the cover of the Waste Bin is closed.
- 5 Power-on:** If the Globe is incorrectly positioned after powering on, the device will automatically reset it through a self-check.

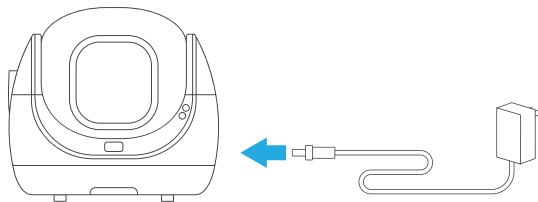

6 Wi-Fi connection

NOTE:

- Place the Unit as close to the router as possible, and make sure the Unit is powered on.
 - Authorize location information, and turn on GPS on your Android phone.
 - Use only letters and numbers in the WiFi name to avoid connection issues.
 - Use a 2.4GHz WiFi network to connect the product. 5GHz WiFi is not supported, and certain locations such as hotels and airports that require special certification of WiFi may also not be supported.
- ① Download the CATLINK app in the application market of your phone or scan the QR code.



CATLINK app



For Android & iOS

- ② Connect your phone to 2.4GHz Wi-Fi.
- ③ Register your account in the app and log in. (Make sure to authorize location information and turn on GPS for your Android phone). On the DEVICE page, click the '+' in the upper right corner, select the SCOOPER SE, and follow the instructions to complete the Wi-Fi connection. If the Unit can't be searched, click SCOOPER SE to add it manually at the bottom of the page, and follow the prompts.
- ④ If you need to add the device manually, press and hold the Clean Button [] for 10 seconds. You will hear two initial beeps, followed by two more beeps. Release the button once the Indicator flashes.
- ⑤ Connect SCOOPER SE to Wi-Fi according to the prompts in the CATLINK app.
- ⑥ After the Wi-Fi connection is successful, the Indicator of the Unit will turn on.
- ⑦ After completing the above steps, you can use the functions in the CATLINK app.

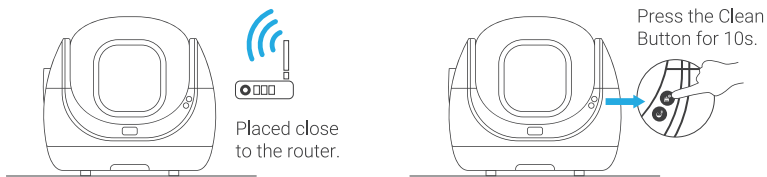

Connection Failed

If you experience connection failure, turn off the power and repeat the steps outlined above. Be sure to read the NOTE under the [WiFi Connection] section of this chapter to ensure that you follow the process correctly and avoid any errors.

If you fail to connect the device, please feel free to contact us.

7 Cat litter

- (1) Press the Add/Empty Button [] to turn the Globe upwards.
- (2) Once the rotation has stopped, add 4L of cat litter.
- (3) After adding litter, press the Add/Empty Button again to level the litter and reset the Globe.
- (4) After leveling litter, make sure that the amount added does not exceed the Max line to avoid wasting litter.

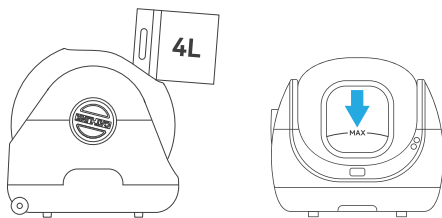

NOTE: Press the Add/Empty Button once before adding litter each time. After adding litter, press the Add/Empty Button again to level it. If you forget to press the Add/Empty Button before adding litter, be sure to run a cleaning cycle after adding litter.

8 Activate and place the Deodorization Hydrogel

(1) Pull out the left Knob.

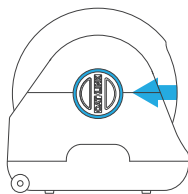

(2) Insert the Deodorization Hydrogel into the Knob.

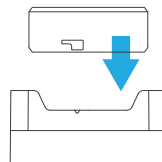

(3) Rotate the Deodorization Hydrogel counter-clockwise to secure it in place.



(4) Peel off the seal of the Deodorization Hydrogel and add the activator.

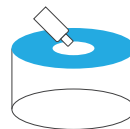

(5) Insert the Knob with the activated Deodorization Hydrogel back into place.

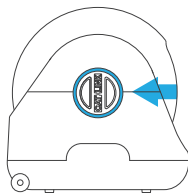

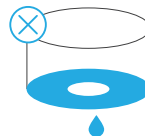

(6) During installation, do not turn the bottle mouth down to avoid the outflow of activation liquid.







NOTE: The Deodorization Hydrogel should be replaced every 60 days.

Congratulations!
Your SCOOPER SE is now ready to use.













04 Clean Modes

Indicator	Mode	Explanation	Note
	Timer	You can schedule regular cleanings in the app. Only clean litter according to the schedule you have set.	It can only be set via app when the WIFI is connected.
	Auto	The litter box will automatically clean itself when your cat exits the Globe.	You can modify the Wait Time in the app, which determines when the litter box will automatically clean up after the cat leaves the Globe. By default, it is set to 5 minutes.
	Manual	You can manually start and pause the cleaning process.	For kittens under 6 months old or weighing less than 3.3 lbs, it is recommended to use Manual mode.

05 Button Functions

Button	Operation	Explanation	Sound
Clean 	Press	Start cleaning	One beep
	Press during cleaning process	Pause cleaning	One beep
	Long press for 3 seconds	Switch clean modes	Two beeps
	Long press for 10 seconds	Enter Wi-Fi connecting mode	Two beeps, and two beeps
Add / Empty 	Press	Add litter	One beep
	Press after adding litter	Level litter	One beep
	Long press for 3 seconds	Start emptying	Two beeps
	Long press for 3 seconds during emptying litter	Cancel emptying	Two beeps
	Long press for 10 seconds	Calibrate weight	Two beeps, and two beeps
Combination Buttons  + 	Long press the two buttons for 3 seconds	Open/close Panel Lock	Two beeps

06 Indicator

Indicator Lights	Status	Explanation	Note
 Panel Lock	ON	Panel Lock On	
	OFF	Panel Lock Off	
 Wi-Fi	Flashing	Wi-Fi connecting	
	ON	Wi-Fi connected	
	OFF	Wi-Fi not connected	
 Empty Mode	ON	The Unit is in Empty Mode.	The Unit in this state can't clean.
	OFF	The Unit is in Clean Mode.	The Unit in this state can't empty.
 Safety Indicator	 Blue Light On	Infrared induction protection	The Unit suspends the operation.
	 Red Light On	Weighing induction protection	The Unit suspends the operation.
	 Purple Light On	Motor failure	The Unit suspends the operation.
	 Purple Light Flashing Fast	The left/right/both Side Covers are not installed properly.	The Unit suspends the operation.
	 Red and Blue Alternately Flashing	Waste Bin Full	
	 Blue Light Flashing	Weighing calibration	
 Safety Indicator	ON	The Unit is in timer Mode.	
 Safety Indicator	ON	The Unit is in auto Mode.	
 Manual Mode	ON	The Unit is in manual Mode.	

07 How to Empty

Empty means removing all the litter from the Globe.

- ① To prevent the Waste Bin from overflowing during the emptying process, replace the Trash Liner with a new one.
**Do not attempt to empty the Waste Bin when it is full.*
- ② Rotate the Knob to the Empty position, and the Empty Pad will cover the Screen.
**Do not rotate the Knob while the Unit is in motion.*
- ③ To start the emptying process, either long press the Add/Empty Button for 3 seconds or select Empty in the app.
**Empty cannot be performed when the Knob is not in the Empty position.*
- ④ Once emptying is complete, rotate the Knob to the Clean position and the Empty Pad will return to its home position.
**Cleaning cannot be performed when the Knob is not in the Clean position.*
- ⑤ After the Knob returns to the Clean position, open the Waste Bin cover and replace the Trash Liner.

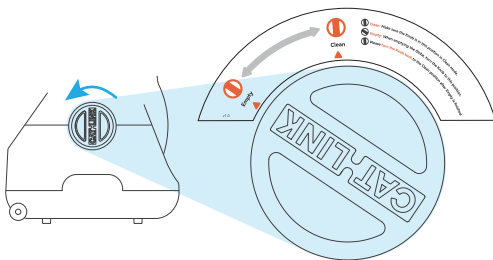

Rotate the Knob to the Empty position.

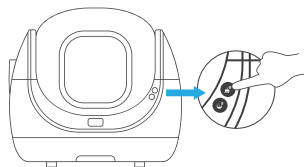

Press and hold the Add/Empty Button for 3 seconds.

08 Move the Unit

(1) Avoid dragging the Unit directly on the floor. Instead, it is recommended to lift the Unit with your hands.

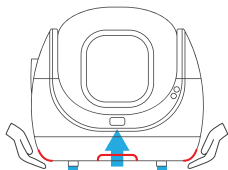

(2) Alternatively, gently lift and slide the SCOOPER SE using the method shown in the figure.

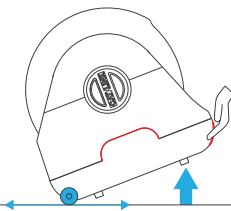

09 How to Clean

Do not wash the Base and avoid spraying any liquids on it. Instead, use a damp cloth to wipe it clean.

The Globe and Side Covers can be washed directly with water. Once done, make sure to dry them thoroughly before reinstalling.

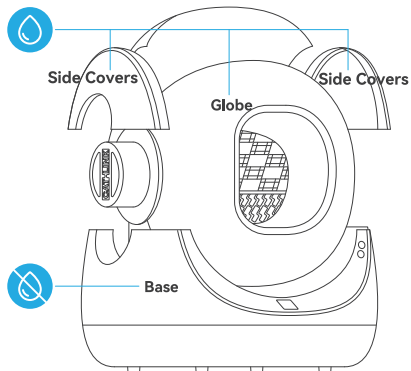

10 Safety Protection System

Protection	Priority	Explanation
Infrared Sensor	Level 1	If an object enters while the Globe is rotating, the infrared protection will be triggered, causing the Globe to stop rotating. The blue safety indicator light will remain on, and an abnormal notification will appear in the app. Once the object has been detected to leave, the Globe will resume rotating.
Gravity Sensor	Level 2	If an object weighing over 3.3 lbs enters during the rotation of the Globe, the weighing protection will automatically stop the rotation. Once the object leaves, the Globe will resume rotating.
Injury Prevention Sensor	Level 3	While the Globe is rotating, if Side Covers are not properly in place, the anti-pinch protection will be triggered, causing the Globe to stop rotating. The safety indicator light will flash purple quickly and an abnormal notification will be sent through the app. This protection can only be lifted after manual intervention.
Motor Protection	Level 4	In the event of unexpected motor resistance during rotation, the Globe will stop rotating and an abnormal notification will appear in the app. The Globe will automatically resume after 10 seconds.

11 Troubleshooting

Trouble	Solution
The Unit stops working due to infrared sensor protection.	<ol style="list-style-type: none">1. Wipe the Indicator clean with a damp cloth.2. Press the Clean Button once to let it perform a self-cleaning.
The Unit stops working due to load cell protection.	Press the Clean Button once to let it perform a self-cleaning.
The Unit stops working due to anti-pinch protection.	Reinstall the Side Covers.

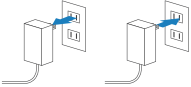
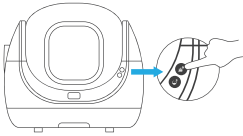
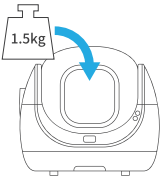
Trouble	Solution	Steps
<p>The weighing data is inaccurate (The inaccuracy caused by the use environment has been excluded)</p>	<p>Weighing calibration</p>	<p>1. Choose a reference. It can be any item that weighs 3.3 lbs such as three 16.9 fl oz bottles of water.</p>
		<p>2. Unplug and restart. </p>
		<p>3. Press and hold the Add/Empty Button for 10 seconds, and release it after hearing 2 beeps. The Safety Indicator light will flash blue.</p> 
		<p>4. Put the reference in the Globe. </p>
		<p>5. The blue light of the Safety Indicator is on, and after hearing a beep, the weighing calibration is completed.</p>

12 Product Specifications

Product Name	CATLINK BayMax Cat Litter Box - SCOOPER SE
Product Model	CL - CA - 01
Main Material	PP
Product Size	23.58 x 20.98 x 21.45 inches
Rated Voltage	12V / 2A
Applicable Scope	Cat (3.3-22 lbs)
Weight	24.25 lbs
Carried Standard	GB 4706.1-2005
Brand	CATLINK
Website	www.catlinkus.com

13 Customer Service

We will provide customers with a one-year free warranty service.

If you have questions or need assistance, contact us!

Phone Support

+1 833 440 2772

Mon-Fri: 10AM-6PM EST

Email Support

support@catlink.cn 24/7



Toll free: +1 833 440 2772 Email: support@catlink.cn