

**BARBECUES : 3 SERIES  
WOODY L - LD - LD G**

**CAMPINGGAZ®**



**3 SERIES WOODY L**



**3 SERIES WOODY LD - LD G**

# BARBECUES : 3 SERIES WOODY L - LD - LD G

5010004931



5010002634

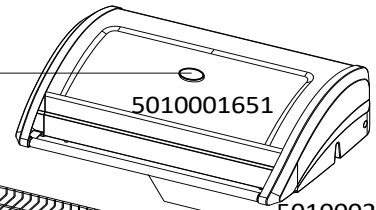

5010002193



5010003147

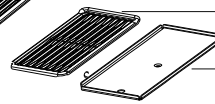

5010001637



5010001598

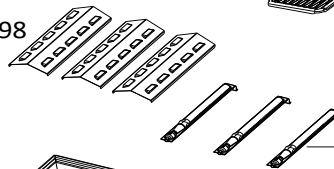

5010002165  
5010002446

5010004726

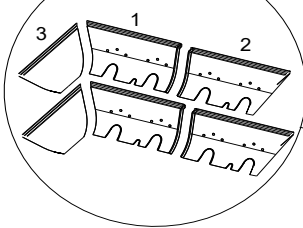

5010002352

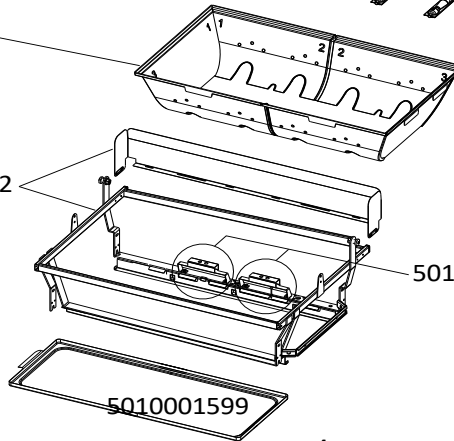

5010002163 (Exp)  
5010002439 (De)  
Butane / propane  
5010002441 (Fr)  
5010004990 (Ch)  
5010005663 (De)  
propane

### JET / INJECTEUR

5010002164 (28Mb)  
5010002448 (50Mb) - Butane and Propane  
5010005664 (50Mb) - Propane

5010002192

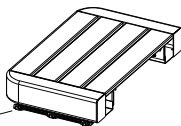

5010002162

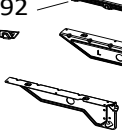

5010004124

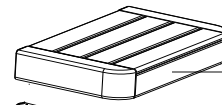

5010002169



5010002170



5010005365



5010004129



5010002168



5010002167



5010001639  
5010003160

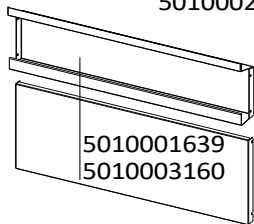

74881

5010005551



5010001593

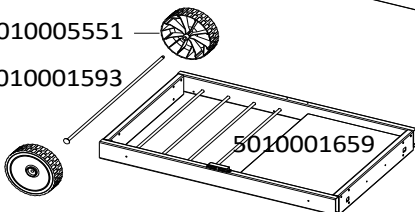

31906

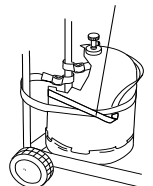

ACCESSORY BAG  
SACHET ACCESSOIRES  
5010004875

SCREW BAG  
SACHET DE VIS  
5010001641

# BARBECUES : 3 SERIES WOODY L - LD - LD G

CAMPINGAZ®

## GERÄTE FÜR DEUTSCHLAND UND ÖSTERREICH

### WARNING!

Gasgrillgeräte für Deutschland und Österreich können mit zwei verschiedenen Gasleitungen ausgestattet sein:

Butan und Propan (50 mbar)

Propan (50 mbar)

Um die für den Grill passende Gasleitung zu finden, schauen Sie bitte auf den am Grill angebrachten Aufkleber, der das



- Logo trägt.

In der mit **DE. AT.** überschriebenen Sektion auf dem Aufkleber (siehe Bilder unten) finden Sie die Version der Gasleitung.

## MODELS FOR GERMANY AND AUSTRIA

### WARNING!

A barbecue used in Germany and Austria is using one of 2 types of gas pipe:

Butane and Propane (50 Mbar)

Propane (50 Mbar)

To find out the type of gas pipe used by a barbecue, see the CE sticker containing the  logo.

In the **DE. AT.** part of the CE label (see pictures below), you will find the type of gas pipe used.

## MODELES DESTINES A L'ALLEMAGNE ET L'AUTRICHE

### ATTENTION !

Un barbecue destiné à l'Allemagne et l'Autriche utilise un des 2 types de tubulure gaz :

Butane et propane à 50 mbar

Propane à 50 mbar

Pour reconnaître le type de tubulure gaz utilisé, consulter l'étiquette CE reconnaissable par le logo 

Dans la partie **DE. AT.** de l'étiquette CE (voir les schémas ci-dessous) , le type de tubulure gaz est indiqué.

### Gasleitung nur für Propan - Propane gas pipe only - Tubulure gaz n'utilisant que le Propane

FR - ATTENTION: Des parties accessibles peuvent être très chaudes. Eloigner les jeunes enfants. A n'utiliser qu'à l'extérieur des locaux. Consulter la notice avant emploi.	
DE - ACHTUNG :Die zugänglichen Teile am Grill können sehr heiß werden. Halten Sie Kinder davon fern. Nur im Freien benützen. Vor Inbetriebnahme Gebrauchsanweisung lesen.	
IT - ATTENZIONE: Alcune parti esposte possono riscaldarsi. Tenere lontano dalla portata dei bambini. Da utilizzarsi solo all'aria aperta. Leggere le istruzioni per l'uso prima di utilizzare l'apparecchio.	
 1312 - YY 1312 CO 5855	<b>DE. AT. CH: Cat. I<sub>3P(50)</sub></b> Propane (G31) 50mbar
<b>APPLICATION DES GAZ</b> 219, Route de Brignais - BP 55 ,69563 Saint Genis Laval - France	

### Gasleitung für Butan und Propan - Butane and Propane gas pipe - Tubulure gaz utilisant le Butane et le Propane

FR - ATTENTION: Des parties accessibles peuvent être très chaudes. Eloigner les jeunes enfants. A n'utiliser qu'à l'extérieur des locaux. Consulter la notice avant emploi.	
DE - ACHTUNG :Die zugänglichen Teile am Grill können sehr heiß werden. Halten Sie Kinder davon fern. Nur im Freien benützen. Vor Inbetriebnahme Gebrauchsanweisung lesen.	
IT - ATTENZIONE: Alcune parti esposte possono riscaldarsi. Tenere lontano dalla portata dei bambini. Da utilizzarsi solo all'aria aperta. Leggere le istruzioni per l'uso prima di utilizzare l'apparecchio.	
 1312 - YY 1312 CO 5855	<b>DE. AT. CH: Cat. I<sub>3BP(50)</sub></b> Butane (G30) 50 mbar - Propane (G31) 50 mbar
<b>APPLICATION DES GAZ</b> 219, Route de Brignais - BP 55 ,69563 Saint Genis Laval - France	

# BARBECUES : 3 SERIES WOODY L - LD - LD G



SPARE PARTS REF.	POINTS	EN DESCRIPTIONS	FR DESCRIPTIONS	3 SERIES WOODY L	3 SERIES WOODY LD / LD G
31906	30	CYLINDER STRAP	SANGLE BOUTEILLE	X	X
74881	30	PLASTIC FOOT	PIED PLASTIQUE	X	X
5010001593	30	WHEEL AXLE	AXE DE ROUE	X	X
5010001596	80	WARMING GRID	GRILLE DE MIJOTAGE	X	X
5010001598	100	STEEL HEAT DIFFUSER (x1)	DIFFUSEUR DE CHALEUR ACIER (x1)	X	X
5010001599	50	GREASE PLATE	PLATEAU RAMASSE GRAISSE	X	X
5010001637	140	STEEL COOKING GRID - SHINY	GRILLE DE CUISSON ACIER - BRILLANTE	X	X
5010001638	160	SMALL THICK STEEL COOKING GRIDDLE - SHINY	PETITE PLAQUE DE CUISSON ACIER EPAIS - BRILLANTE	X	X
5010001639	140	FRONT SHEET (TOP + BOTTOM) - LIGHT GREY	JUPE TOLE (HAUT + BAS) - GRIS CLAIR	X	
5010001641	70	SCREW BAG	SACHET DE VIS	X	X
5010001651	550	LID WITH THERMOMETER - BLACK	COUVERCLE AVEC THERMOMETRE - NOIR	X	X
5010001659	220	CHASSIS (MOD. BEFORE 2018)	CHASSIS (MOD. AVANT 2018)	X	X
5010002162	70	KNOB (x2)	VOLANT (x2)	X	X
5010002163	200	GAS PIPE 28Mb (Export)	TUBULURE 28Mb (Export)	X	X
5010002164	30	JET 28Mb	INJECTEUR 28Mb	X	X
5010002165	120	STAINLESS STEEL BURNER 28Mb	BRULEUR INOX 28Mb	X	X
5010002167	350	KIT LEGS (x4) (MODEL BEFORE 2018)	KIT PIEDS (x4) (MODELE AVANT 2018)	X	X
5010002168	60	WELDED FRAME SUPPORT	RENFORT LATERAL SUPPORT CUVE	X	X
5010002169	60	RIGHT FLANK	FLANC DROIT	X	X
5010002170	60	LEFT FLANK	FLANC GAUCHE	X	X
5010002192	40	USTENSIL HOOK	PORTE USTENSILES	X	X
5010002193	70	STAINLESS STEEL HANDLE + INSULATING + ENDS	POIGNEE INOX + ISOLANT + EMBOUTS	X	X
5010002352	220	BASE FRAME + WINDSHIELD	CADRE SUPPORT DE CUVE + PAREVENT	X	X
5010002439	300	GAS PIPE 50Mb 1/4" (De) - BUTANE AND PROPANE MODELS	TUBULURE 50Mb 1/4" (De) - MODELES BUTANE ET PROPANE	X	X
5010002441	270	GAS PIPE 28Mb 1/2" (Fr)	TUBULURE 28Mb 1/2" (Fr)	X	X
5010002446	110	STAINLESS STEEL BURNER 50Mb	BRULEUR INOX 50Mb	X	X
5010002448	30	JET 50Mb - FOR BUTANE AND PROPANE GAS PIPE	INJECTEUR 50Mb - POUR TUBULURE GAZ BUTANE ET PROPANE	X	X
5010002634	50	THERMOMETER WITH BEZEL	THERMOMETRE AVEC COUPELLE	X	X
5010003147	110	SMALL STEEL ENAMELLED COOKING GRID - SHINY	PETITE GRILLE DE CUISSON EMAILLEE - BRILLANTE		X
5010003160	100	FRONT SHEET (TOP + BOTTOM) (DARK GREY)	JUPE TOLE (HAUT + BAS) (GRIS FONCE)	X	X
5010004124	220	LEFT OR RIGHT WOODY SIDE TABLE - TEXTURED DARK GREY	ETAGERE BOIS GAUCHE OU DROITE - GRAINE GRIS FONCE	X	X
5010004129	110	TOP + BOTTOM FRONT PANELS - TEXTURED DARK GREY	CONSOLES HAUT + BAS - GRAINE GRIS FONCE	X	X
5010004726	290	KIT OF REMOVABLE PARTS (FIREBOX)	KIT DE PARTIES AMOVIBLES (CUVE)	X	X
5010004875	100	ACCESSORY BAG	SACHET D'ACCESSOIRES	X	X
5010004931	50	LID PADS(x2) + BASE CUSHIONS(x2) + LEG GROMMETS(x4)	PATINS COUVERCLE(x2) + BOUCHONS CUVE(x2) + RONDELLES PIED(x4)	X	X
5010004990	250	GAS PIPE 28Mb 1/4" (Ch)	TUBULURE 28Mb 1/4" (Ch)	X	X
5010005365	50	PIEZO DOUBLE	PIEZO DOUBLE	X	X
5010005398	90	KIT OF ELECTRODES + HOUSINGS	KIT ELECTRODES + SUPPORTS	X	X
5010005551	50	WHEEL DIAMETER 160 (X 1) WITH CHROMED CAP	ROUE DIAMETRE 160 (X 1) AVEC ENJOLIVEUR CHROME	X	X
5010005663	300	GAS PIPE 50Mb 1/4" (De) - PROPANE MODELS ONLY	TUBULURE 50Mb 1/4" (De) - MODELES PROPANE UNIQUEMENT	X	X
5010005664	30	JET 50Mb - FOR PROPANE GAS PIPE ONLY	INJECTEUR 50Mb - POUR TUBULURE GAZ PROPANE UNIQUEMENT	X	X