

**BARBECUE : MASTER 3 SERIES  
CLASSIC LXS**  
(MOD. FROM / A PARTIR DE 2018)

**CAMPINGAZ**

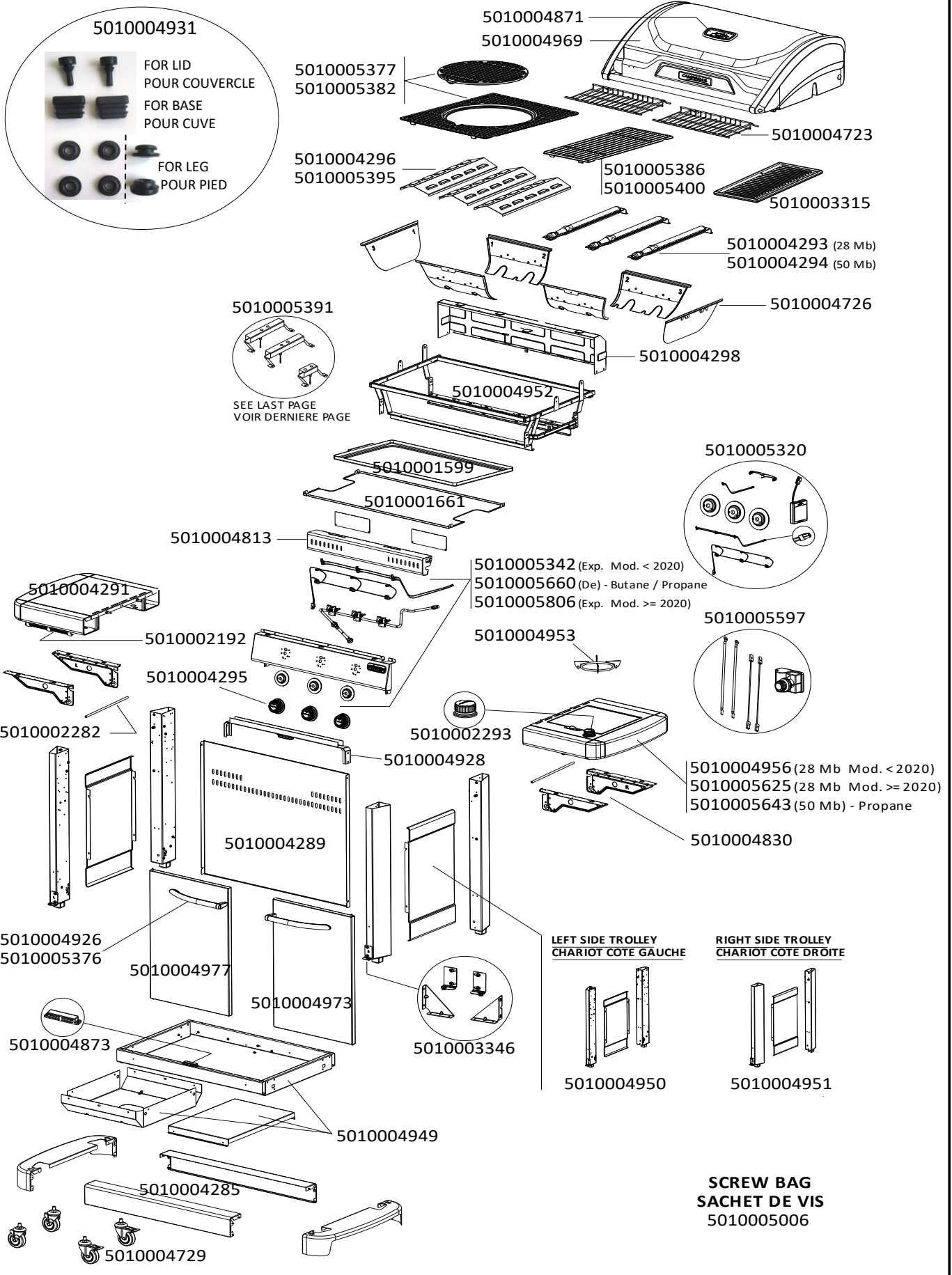

# BARBECUE : MASTER 3 SERIES CLASSIC LXS (MOD. FROM / A PARTIR DE 2018)



# BARBECUE : MASTER 3 SERIES CLASSIC LXS (MOD. FROM / A PARTIR DE 2018)

CAMPINGAZ®

## GERÄTE FÜR DEUTSCHLAND UND ÖSTERREICH

### WARNUNG!

Gasgrillgeräte für Deutschland und Österreich können mit zwei verschiedenen Gasleitungen ausgestattet sein:

Butan und Propan (50 mbar)

Propan (50 mbar)

Um die für den Grill passende Gasleitung zu finden, schauen Sie bitte auf den am Grill angebrachten Aufkleber, der das



Logo trägt (hinter der Rückwand angeordnet)

In der mit **DE. AT.** überschriebenen Sektion auf dem Aufkleber (siehe Bilder unten) finden Sie die Version der Gasleitung.

## MODELS FOR GERMANY AND AUSTRIA

### WARNING!

A barbecue used in Germany and Austria is using one of 2 types of gas pipe:

Butane and Propane (50 Mbar)

Propane (50 Mbar)

To find out the type of gas pipe used by a barbecue, see the CE sticker containing the  logo (located behind the rear panel).

In the **DE. AT.** part of the CE label (see pictures below), you will find the type of gas pipe used.

## MODELES DESTINES A L'ALLEMAGNE ET L'AUTRICHE

### ATTENTION !

Un barbecue destiné à l'Allemagne et l'Autriche utilise un des 2 types de tubulure gaz :

Butane et propane à 50 mbar

Propane à 50 mbar

Pour reconnaître le type de tubulure gaz utilisé, consulter l'étiquette CE (placée derrière le panneau arrière) reconnaissable par le logo 

Dans la partie **DE. AT.** de l'étiquette CE (voir les schémas ci-dessous) , le type de tubulure gaz est indiqué.

### Gasleitung nur für Propan - Propan gas pipe only - Tubulure gaz n'utilisant que le Propane

 1312 - YY 1312 CO 5855	<b>DE. AT. CH:</b> Cat. I <sub>3BP (50)</sub> Propane (G31) 50mbar
	<b>APPLICATION DES GAZ</b> 219, Route de Brignais - BP 55 ,69563 Saint Genis Laval - France

### Gasleitung für Butan und Propan - Butan and Propan gas pipe - Tubulure gaz utilisant le Butane et le Propane

 1312 - YY 1312 CO 5855	<b>DE. AT. CH:</b> Cat. I <sub>3BP (50)</sub> Butane (G30) 50 mbar - Propane (G31) 50 mbar
	<b>APPLICATION DES GAZ</b> 219, Route de Brignais - BP 55 ,69563 Saint Genis Laval - France

**BARBECUE : MASTER 3 SERIES  
CLASSIC LXS  
(MOD. FROM / A PARTIR DE 2018)**



SPARE PARTS REF.	POINTS	EN DESCRIPTIONS	FR DESCRIPTIONS
5010001599	50	GREASE PLATE	PLATEAU RAMASSE GRAISSE
5010001661	60	HEAT SHIELD	PARE CHALEUR
5010002192	40	USTENSIL HOOK	PORTE USTENSILES
5010002282	30	REINFORCEMENT WIRE SIDE SHELF	FIL RENFORT ETAGERE
5010002293	50	KNOB FOR SIDE STOVE	VOLANT POUR RECHAUD LATERAL
5010003315	200	REVERSIBLE SMALL ENAMELLED CAST IRON GRIDDLE - MATTE	PETITE PLAQUE DE CUISSON FONTE REVERSIBLE EMAILLEE - MATE
5010003346	40	AXLE SUPPORTS FOR DOORS (MOD. 2016 AND AFTER) + 2 CHASSIS SQUARES	SUPPORTS AXE PORTES (MOD. A PARTIR DE 2016) + 2 EQUERRES CHASSIS
5010004285	170	SKIRT	JUPE
5010004289	110	REAR PANEL	PANNEAU ARRIERE
5010004291	190	LEFT SIDE TABLE W/ USTENSIL HOOK	ETAGERE GAUCHE AVEC PORTE USTENSILES
5010004293	180	STAINLESS STEEL BURNER 28Mb	BRULEUR INOX 28Mb
5010004294	180	STAINLESS STEEL BURNER 50Mb	BRULEUR INOX 50Mb
5010004295	60	KNOB (X3)	VOLANT (X3)
5010004296	120	ENAMELLED STEEL HEAT DIFFUSER (X1)	DIFFUSEUR DE CHALEUR ACIER EMAILLE (X1)
5010004298	60	WINDSHIELD	PAREVENT
5010004723	80	WARMING GRID (X2)	GRILLE DE MIJOTAGE (X2)
5010004726	290	KIT OF REMOVABLE PARTS (FIREBOX)	KIT DE PARTIES AMOVIBLES (CUVE)
5010004729	70	SET OF WHEELS (x2)	ENSEMBLE ROUES (x2)
5010004813	60	TOP FRONT PANEL WITH SHIELD (X2)	CONSOLE HAUT AVEC ECRAN THERMIQUE (X2)
5010004830	60	SIDE SHELF SUPPORTS (RIGHT AND LEFT) - TEXTURED DARK GREY	SUPPORTS ETAGERE (DROITE ET GAUCHE) - GRAINE GRIS FONCE
5010004871	90	THERMOMETER WITH NUTS	THERMOMETRE AVEC ECROUS
5010004873	50	MAGNETS (X2)	AIMANTS (X2)
5010004926	50	CHROMED PLASTIC HANDLE (LEFT OR RIGHT) + SCREWS (MOD. BEFORE 2019)	POIGNEE PLASTIQUE CHROME (GAUCHE OU DROITE) + VIS (MOD. AVANT 2019)
5010004928	50	TROLLEY TOP REINFORCEMENT BAR	BARRE SUPERIEURE DE RENFORT CHARIOT
5010004931	50	LID PADS(x2) + BASE CUSHIONS(x2) + LEG GROMMETS(x4)	PATINS COUVERCLE(x2) + BOUCHONS CUVE(x2) + RONDELLES PIED(x4)
5010004949	250	CHASSIS (MOD. FROM 2018)	CHASSIS (MOD. A PARTIR DE 2018)
5010004950	210	LEFT SIDE PANEL W/ LEGS (MOD. 2018-2019)	PANNEAU GAUCHE AVEC PIEDS (MOD. 2018-2019)
5010004951	210	RIGHT SIDE PANEL W/ LEGS (MOD. 2018-2019)	PANNEAU DROITE AVEC PIEDS (MOD. 2018-2019)
5010004952	180	BASE FRAME (MOD. 2018)	CADRE SUPPORT DE CUVE (MOD. 2018)
5010004953	60	SIDE STOVE PAN SUPPORT	SUPPORT DE CASSEROLE RECHAUD LATERAL
5010004956	610	SIDE BURNER TABLE WITH STAINLESS STEEL GAS PIPE 28Mb	ETAGERE RECHAUD LATERAL AVEC TUBULURE INOX 28Mb
5010004969	750	BLACK ENAMELLED LID WITH THERMOMETER	COUVERCLE EMAILLE NOIR AVEC THERMOMETRE
5010004973	240	RIGHT DOOR WITHOUT HANDLE - DARK GREY	PORTE DROITE SANS POIGNEE - GRIS FONCE
5010004977	240	LEFT DOOR WITHOUT HANDLE - DARK GREY	PORTE GAUCHE SANS POIGNEE - GRIS FONCE
5010005006	80	SCREW BAG	SACHET DE VIS
5010005320	250	ELECTRONIC IGNITION SET	KIT ALLUMAGE ELECTRONIQUE
5010005342	600	CONTROL PANEL + WIRES (BACKLIGHTING+IGNITION) + STOVE PIPE 28Mb (Export)	CONSOLE + CABLAGE (ECLAIRAGE+IGNITION) + TUBULURE RECHAUD 28Mb (Export)
5010005376	120	CHROMED STEEL HANDLE (LEFT OR RIGHT) + SCREWS (MOD. FROM 2019)	POIGNEE ACIER CHROME (GAUCHE OU DROITE) + VIS (MOD. A PARTIR DE 2019)
5010005377	250	ENAMELLED CAST IRON GRID (FRAME + CIRCLE) - MATTE (MOD. FROM 2019)	GRILLE FONTE EMAILLEE (CADRE + CERCLE) - MATE (MOD. A PARTIR DE 2019)
5010005382	300	ENAMELLED CAST IRON GRID (FRAME + CIRCLE) - SHINY (MOD. FROM 2019)	GRILLE FONTE EMAILLEE (CADRE+CERCLE) - BRILLANTE (MOD. A PARTIR DE 2019)
5010005386	160	ENAMELLED CAST IRON GRID - SHINY (MOD. FROM 2019)	GRILLE DE CUISSON FONTE EMAILLEE - BRILLANTE (MOD. A PARTIR DE 2019)
5010005391	130	KIT OF ELECTRODES + HOUSINGS	KIT ELECTRODES + SUPPORTS
5010005395	60	STAINLESS STEEL HEAT DIFFUSOR (X1)	DIFFUSEUR DE CHALEUR INOX (X1)

# BARBECUE : MASTER 3 SERIES CLASSIC LXS (MOD. FROM / A PARTIR DE 2018)

SPARE PARTS REF.	POINTS	EN DESCRIPTIONS	FR DESCRIPTIONS
5010005400	140	SMALL ENAMELLED CAST IRON GRID - MATTE (MOD. FROM 2019)	PETITE GRILLE DE CUISSON FONTE EMAILLEE - MATE (MOD. A PARTIR DE 2019)
5010005597	180	ELECTRONIC IGNITION SET (2/4 OUTLETS) WITH CONNECTION WIRES	KIT ALLUMAGE ELECTRONIQUE (2/4 SORTIES) AVEC CABLES DE CONNECTIONS
5010005625	600	SIDE BURNER TABLE WITH STAINLESS STEEL GAS PIPE 28Mb	ETAGERE RECHAUD LATERAL AVEC TUBULURE INOX 28Mb
5010005643	590	SIDE BURNER TABLE WITH STAINLESS STEEL GAS PIPE 50Mb (De) - PROPANE MODELS ONLY	ETAGERE RECHAUD LATERAL AVEC TUBULURE INOX 50Mb (De) - MODELES PROPANE UNIQUEMENT
5010005660	740	CONTROL PANEL + WIRES (BACKLIGHTING + IGNITION) + PIPE 50Mb 1/2" (De) - BUTANE AND PROPANE MODELS	CONSOLE + CABLAGE (ECLAIRAGE + ALLUMAGE) + TUBULURE 50Mb (De) - MODELES BUTANE ET PROPANE
5010005806	600	CONTROL PANEL + WIRES (BACKLIGHTING+IGNITION) + STOVE PIPE 28Mb (Export)	CONSOLE + CABLAGE (ECLAIRAGE+IGNITION) + TUBULURE RECHAUD 28Mb (Export)

5010005391

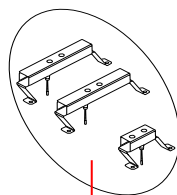

**1**

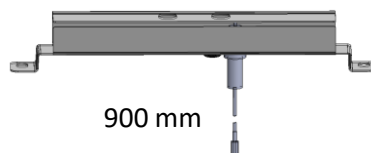

970 mm

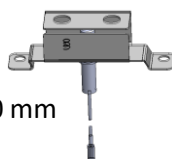

**2**

