

**BARBECUE : MASTER 3 SERIES
CLASSIC WL
(MOD. FROM / A PARTIR DE 2018)**

CAMPINGAZ

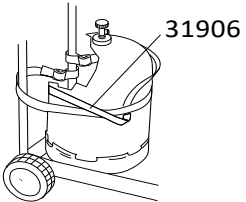

**BARBECUE : MASTER 3 SERIES
CLASSIC WL
(MOD. FROM / A PARTIR DE 2018)**

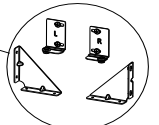
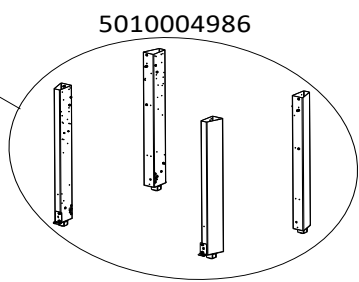
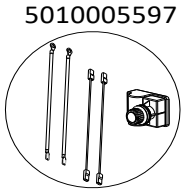
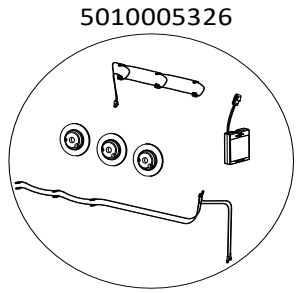

**SCREW BAG
SACHET DE VIS
5010005006**

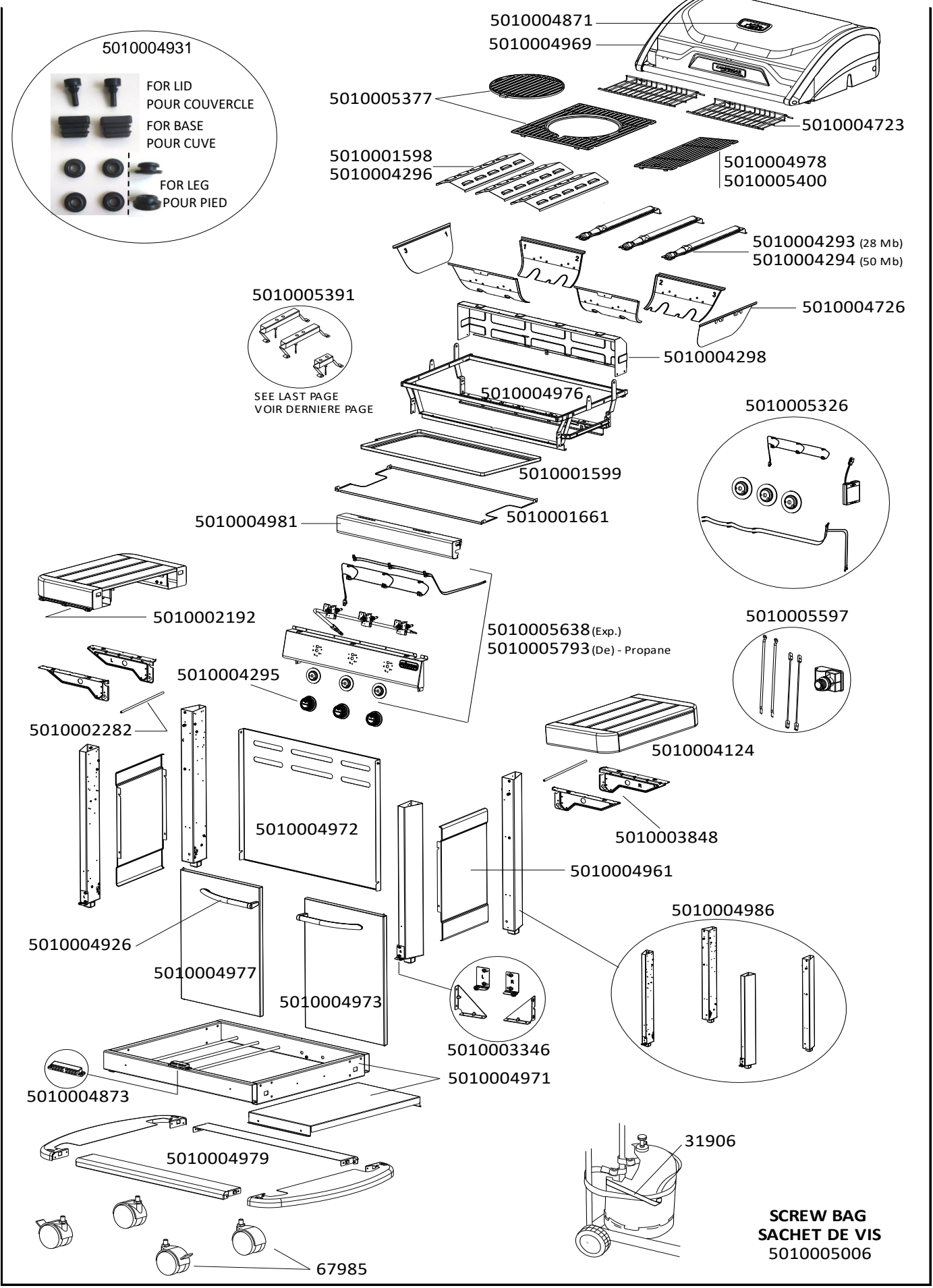

BARBECUE : MASTER 3 SERIES CLASSIC WL (MOD. FROM / A PARTIR DE 2018)

CAMPINGAZ®

GERÄTE FÜR DEUTSCHLAND UND ÖSTERREICH WARNUNG!

Gasgrillgeräte für Deutschland und Österreich können mit zwei verschiedenen Gasleitungen ausgestattet sein:

Butan und Propan (50 mbar)

Propan (50 mbar)

Um die für den Grill passende Gasleitung zu finden, schauen Sie bitte auf den am Grill angebrachten Aufkleber, der das



- Logo trägt (hinter der Rückwand angeordnet)

In der mit **DE. AT.** überschriebenen Sektion auf dem Aufkleber (siehe Bilder unten) finden Sie die Version der Gasleitung.

MODELS FOR GERMANY AND AUSTRIA WARNING!

A barbecue used in Germany and Austria is using one of 2 types of gas pipe:

Butane and Propane (50 Mbar)

Propane (50 Mbar)

To find out the type of gas pipe used by a barbecue, see the CE sticker containing the  logo (located behind the rear panel).

In the **DE. AT.** part of the CE label (see pictures below), you will find the type of gas pipe used.

MODELES DESTINES A L'ALLEMAGNE ET L'AUTRICHE ATTENTION !

Un barbecue destiné à l'Allemagne et l'Autriche utilise un des 2 types de tubulure gaz :

Butane et propane à 50 mbar

Propane à 50 mbar

Pour reconnaître le type de tubulure gaz utilisé, consulter l'étiquette CE (placée derrière le panneau arrière) reconnaissable par le logo 

Dans la partie **DE. AT.** de l'étiquette CE (voir les schémas ci-dessous) , le type de tubulure gaz est indiqué.

Gasleitung nur für Propan - Propan gas pipe only - Tubulure gaz n'utilisant que le Propane

FR - ATTENTION: Des parties accessibles peuvent être très chaudes. Eloigner les jeunes enfants. A n'utiliser qu'à l'extérieur des locaux. Consulter la notice avant emploi. DE - ACHTUNG :Die zugänglichen Teile am Grill können sehr heiß werden. Halten Sie Kinder davon fern. Nur im Freien benützen. Vor Inbetriebnahme Gebrauchsanweisung lesen. IT - ATTENZIONE: Alcune parti esposte possono riscaldarsi. Tenere lontano dalla portata dei bambini. Da utilizzarsi solo all'aria aperta. Leggere le istruzioni per l'uso prima di utilizzare l'apparecchio.	
 1312 - YY 1312 CO 5855	DE. AT. CH: Cat. I_{30/P (50)} Propane (G31) 50mbar APPLICATION DES GAZ 219, Route de Brignais - BP 55 ,69563 Saint Genis Laval - France

Gasleitung für Butan und Propan - Butan and Propan gas pipe - Tubulure gaz utilisant le Butane et le Propane

FR - ATTENTION: Des parties accessibles peuvent être très chaudes. Eloigner les jeunes enfants. A n'utiliser qu'à l'extérieur des locaux. Consulter la notice avant emploi. DE - ACHTUNG :Die zugänglichen Teile am Grill können sehr heiß werden. Halten Sie Kinder davon fern. Nur im Freien benützen. Vor Inbetriebnahme Gebrauchsanweisung lesen. IT - ATTENZIONE: Alcune parti esposte possono riscaldarsi. Tenere lontano dalla portata dei bambini. Da utilizzarsi solo all'aria aperta. Leggere le istruzioni per l'uso prima di utilizzare l'apparecchio.	
 1312 - YY 1312 CO 5855	DE. AT. CH: Cat. I_{30/P (50)} Butane (G30) 50 mbar - Propane (G31) 50 mbar APPLICATION DES GAZ 219, Route de Brignais - BP 55 ,69563 Saint Genis Laval - France

**BARBECUE : MASTER 3 SERIES
CLASSIC WL
(MOD. FROM / A PARTIR DE 2018)**



SPARE PARTS REF.	POINTS	EN DESCRIPTIONS	FR DESCRIPTIONS
31906	30	CYLINDER STRAP	SANGLE BOUTEILLE
67985	90	SET OF WHEELS (x2)	ENSEMBLE ROUES (x2)
5010001598	100	STEEL HEAT DIFFUSER (x1) (MOD. BEFORE 1019)	DIFFUSEUR DE CHALEUR ACIER (x1) (MOD. AVANT 2019)
5010001599	50	GREASE PLATE	PLATEAU RAMASSE GRAISSE
5010001661	60	HEAT SHIELD	PARE CHALEUR
5010002192	40	USTENSIL HOOK	PORTE USTENSILES
5010002282	30	REINFORCEMENT WIRE SIDE SHELF	FIL RENFORT ETAGERE
5010003346	40	AXLE SUPPORTS FOR DOORS (MOD. 2016 AND AFTER) + 2 CHASSIS SQUARES	SUPPORTS AXE PORTES (MOD. A PARTIR DE 2016) + 2 EQUERRES CHASSIS
5010003848	70	RIGHT AND LEFT SIDE SHELF SUPPORTS	SUPPORTS (DROITE ET GAUCHE) ETAGERE
5010004124	220	LEFT OR RIGHT WOODY SIDE TABLE - TEXTURED DARK GREY	ETAGERE BOIS GAUCHE OU DROITE - GRAINE GRIS FONCE
5010004293	180	STAINLESS STEEL BURNER 28Mb	BRULEUR INOX 28Mb
5010004294	180	STAINLESS STEEL BURNER 50Mb	BRULEUR INOX 50Mb
5010004295	60	KNOB (X3)	VOLANT (X3)
5010004296	120	ENAMELLED STEEL HEAT DIFFUSER (X1) (MOD. FROM 2019)	DIFFUSEUR DE CHALEUR ACIER EMAILLE (X1) (MOD. A PARTIR DE 2019)
5010004298	60	WINDSHIELD	PAREVENT
5010004723	80	WARMING GRID (X2)	GRILLE DE MIJOTAGE (X2)
5010004726	290	KIT OF REMOVABLE PARTS (FIREBOX)	KIT DE PARTIES AMOVIBLES (CUVE)
5010004871	90	THERMOMETER WITH NUTS	THERMOMETRE AVEC ECROUS
5010004873	50	MAGNETS (X2)	AIMANTS (X2)
5010004926	50	CHROMED PLASTIC HANDLE (LEFT OR RIGHT) + SCREWS (MOD. BEFORE 2019)	POIGNEE PLASTIQUE CHROME (GAUCHE OU DROITE) + VIS (MOD. AVANT 2019)
5010004931	50	LID PADS(x2) + BASE CUSHIONS(x2) + LEG GROMMETS(x4)	PATINS COUVERCLE(x2) + BOUCHONS CUVE(x2) + RONDELLES PIED(x4)
5010004961	70	LEFT OR RIGHT SIDE PANEL (TEXTURED DARK GREY)	PANNEAU LATERAL GAUCHE OU DROITE (GRAINE GRIS FONCE)
5010004969	750	BLACK ENAMELLED LID WITH THERMOMETER	COUVERCLE EMAILLE NOIR AVEC THERMOMETRE
5010004971	200	CHASSIS	CHASSIS
5010004972	90	REAR PANEL	PANNEAU ARRIERE
5010004973	240	RIGHT DOOR WITHOUT HANDLE - DARK GREY	PORTE DROITE SANS POIGNEE - GRIS FONCE
5010004976	180	BASE FRAME	CADRE SUPPORT DE CUVE
5010004977	240	LEFT DOOR WITHOUT HANDLE - DARK GREY	PORTE GAUCHE SANS POIGNEE - GRIS FONCE
5010004978	140	SMALL CAST IRON COOKING GRID - MATTE	PETITE GRILLE DE CUISSON FONTE - MATE
5010004979	120	SKIRT	JUPE
5010004981	60	TOP FRONT PANEL	CONSOLE HAUT
5010004986	290	KIT LEGS (x4)	KIT PIEDS (x4)
5010005006	80	SCREW BAG	SACHET DE VIS
5010005326	250	ELECTRONIC IGNITION SET	KIT ALLUMAGE ELECTRONIQUE
5010005377	250	ENAMELLED CAST IRON GRID (FRAME + CIRCLE) - MATTE (MOD. FROM 2019)	GRILLE FONTE EMAILLEE (CADRE + CERCLE) - MATE (MOD. A PARTIR DE 2019)
5010005391	130	KIT OF ELECTRODES + HOUSINGS	KIT ELECTRODES + SUPPORTS
5010005400	140	SMALL ENAMELLED CAST IRON GRID - MATTE (MOD. FROM 2019)	PETITE GRILLE DE CUISSON FONTE EMAILLEE - MATE (MOD. A PARTIR DE 2019)
5010005597	180	ELECTRONIC IGNITION SET (2/4 OUTLETS) WITH CONNECTION WIRES	KIT ALLUMAGE ELECTRONIQUE (2/4 SORTIES) AVEC CABLES DE CONNECTIONS
5010005638	450	CONTROL PANEL + WIRES (BACKLIGHTING + IGNITION) + PIPE 28Mb (Export)	CONSOLE + CABLAGE (ECLAIRAGE + ALLUMAGE) + TUBULURE 28Mb (Export)
5010005793	740	CONTROL PANEL + WIRES (BACKLIGHTING+IGNITION) + PIPE 50Mb 1/4"(De) - PROPANE MODELS ONLY	CONSOLE + CABLAGE (ECLAIRAGE+IGNITION) + TUBULURE 50Mb 1/4"(De) - MODELES PROPANE UNIQUEMENT

**BARBECUE : MASTER 3 SERIES
CLASSIC WL
(MOD. FROM / A PARTIR DE 2018)**

5010005391

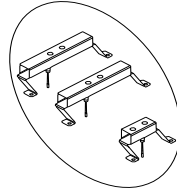

1

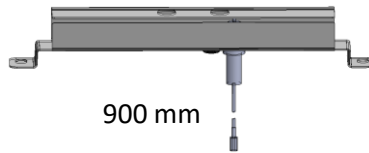

900 mm

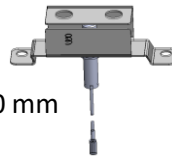

970 mm

2

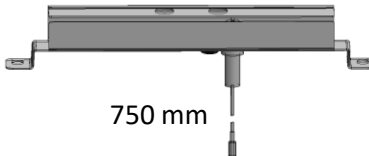

750 mm

1

2

