

BARBECUE : MASTER 3 SERIES WOODY



BARBECUE : MASTER 3 SERIES WOODY

5010004931



FOR LID
POUR COUVERCLE
FOR BASE
POUR CUVE
FOR LEG
POUR PIED

5010004871
5010004300

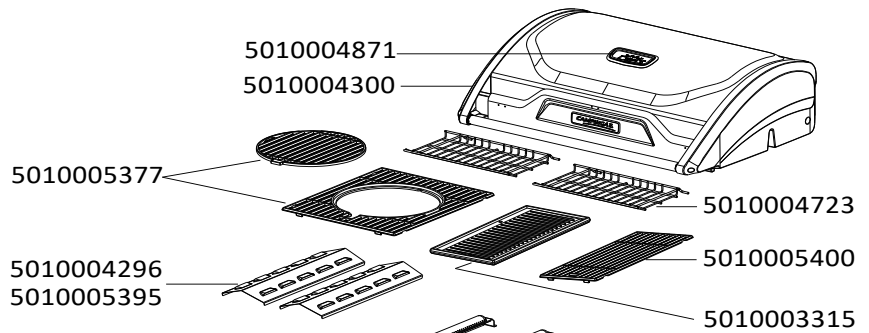

5010005377

5010004723

5010004296
5010005395

5010005400

5010003315

5010004293 (28 Mb)
5010004294 (50 Mb)

5010005391

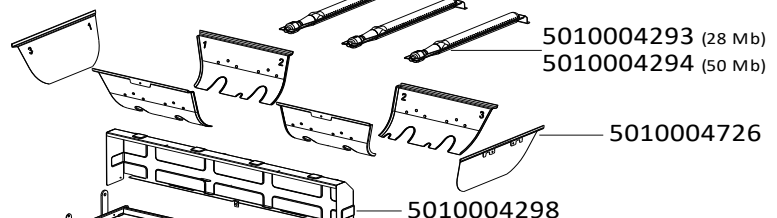
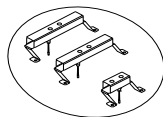

5010004298

5010004748 (Mod. 2017)
5010004952 (Mod. 2018)
5010005390 (Mod. >= 2019)

5010001599

5010001661

5010004813

5010005624 (Ch)
5010005638 (Exp.)
5010005650 (De) - propane

5010005336

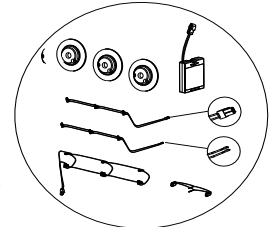

5010002192
5010004295

5010004124

5010005597

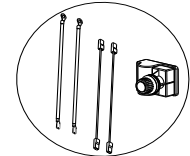

5010004928

5010002282

5010003848

5010004289

5010004926
5010005376

5010004281

5010004282

5010003346

LEFT SIDE TROLLEY
CHARIOT COTE GAUCHE

RIGHT SIDE TROLLEY
CHARIOT COTE DROITE

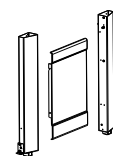
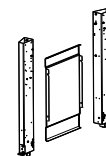

5010004288 Mod. >= 2018 5010004287
5010004950 Mod. 2017 5010004951

5010004873

5010004738 (Mod. 2017)
5010004949 (Mod. >= 2018)

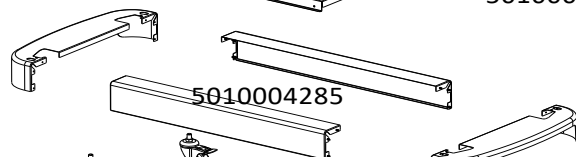

5010004285

SCREW BAG
SACHET DE VIS
5010005006

5010004729

BARBECUE : MASTER 3 SERIES WOODY

GERÄTE FÜR DEUTSCHLAND UND ÖSTERREICH

WARNING!

Gasgrillgeräte für Deutschland und Österreich können mit zwei verschiedenen Gasleitungen ausgestattet sein:

Butan und Propan (50 mbar)

Propan (50 mbar)

Um die für den Grill passende Gasleitung zu finden, schauen Sie bitte auf den am Grill angebrachten Aufkleber, der das



- Logo trägt (hinter der Rückwand angeordnet)

In der mit **DE. AT.** überschriebenen Sektion auf dem Aufkleber (siehe Bilder unten) finden Sie die Version der Gasleitung.

MODELS FOR GERMANY AND AUSTRIA

WARNING!

A barbecue used in Germany and Austria is using one of 2 types of gas pipe:

Butane and Propane (50 Mbar)

Propane (50 Mbar)

To find out the type of gas pipe used by a barbecue, see the CE sticker containing the  logo (located behind the rear panel).

In the **DE. AT.** part of the CE label (see pictures below), you will find the type of gas pipe used.

MODELES DESTINES A L'ALLEMAGNE ET L'AUTRICHE

ATTENTION !

Un barbecue destiné à l'Allemagne et l'Autriche utilise un des 2 types de tubulure gaz :

Butane et propane à 50 mbar

Propane à 50 mbar

Pour reconnaître le type de tubulure gaz utilisé, consulter l'étiquette CE (placée derrière le panneau arrière) reconnaissable par le logo 

Dans la partie **DE. AT.** de l'étiquette CE (voir les schémas ci-dessous) , le type de tubulure gaz est indiqué.

Gasleitung nur für Propan - Propan gas pipe only - Tubulure gaz n'utilisant que le Propane

FR - ATTENTION: Des parties accessibles peuvent être très chaudes. Eloigner les jeunes enfants. A n'utiliser qu'à l'extérieur des locaux. Consulter la notice avant emploi.	
DE - ACHTUNG :Die zugänglichen Teile am Grill können sehr heiß werden. Halten Sie Kinder davon fern. Nur im Freien benützen. Vor Inbetriebnahme Gebrauchsanweisung lesen.	
IT - ATTENZIONE: Alcune parti esposte possono riscaldarsi. Tenere lontano dalla portata dei bambini. Da utilizzarsi solo all'aria aperta. Leggere le istruzioni per l'uso prima di utilizzare l'apparecchio.	
 1312 - YY 1312 CO 5855	DE. AT. CH: Cat. I _{3BP (50)} Propane (G31) 50mbar
APPLICATION DES GAZ 219, Route de Brignais - BP 55 ,69563 Saint Genis Laval - France	

Gasleitung für Butan und Propan - Butan and Propan gas pipe - Tubulure gaz utilisant le Butane et le Propane

FR - ATTENTION: Des parties accessibles peuvent être très chaudes. Eloigner les jeunes enfants. A n'utiliser qu'à l'extérieur des locaux. Consulter la notice avant emploi.	
DE - ACHTUNG :Die zugänglichen Teile am Grill können sehr heiß werden. Halten Sie Kinder davon fern. Nur im Freien benützen. Vor Inbetriebnahme Gebrauchsanweisung lesen.	
IT - ATTENZIONE: Alcune parti esposte possono riscaldarsi. Tenere lontano dalla portata dei bambini. Da utilizzarsi solo all'aria aperta. Leggere le istruzioni per l'uso prima di utilizzare l'apparecchio.	
 1312 - YY 1312 CO 5855	DE. AT. CH: Cat. I _{3BP (50)} Butane (G30) 50 mbar - Propane (G31) 50 mbar
APPLICATION DES GAZ 219, Route de Brignais - BP 55 ,69563 Saint Genis Laval - France	

BARBECUE : MASTER 3 SERIES WOODY

SPARE PARTS REF.	POINTS	EN DESCRIPTIONS	FR DESCRIPTIONS
5010001599	50	GREASE PLATE	PLATEAU RAMASSE GRAISSE
5010001661	60	HEAT SHIELD	PARE CHALEUR
5010002192	40	USTENSIL HOOK	PORTE USTENSILES
5010002282	30	REINFORCEMENT WIRE SIDE SHELF	FIL RENFORT ETAGERE
5010003315	200	REVERSIBLE SMALL ENAMELLED CAST IRON GRIDDLE - MATTE	PETITE PLAQUE DE CUISSON FONTE REVERSIBLE EMAILLEE - MATE
5010003346	40	AXLE SUPPORTS FOR DOORS (MOD. 2016 AND AFTER) + 2 CHASSIS SQUARES	SUPPORTS AXE PORTES (MOD. A PARTIR DE 2016) + 2 EQUERRES CHASSIS
5010003848	70	RIGHT AND LEFT SIDE SHELF SUPPORTS	SUPPORTS (DROITE ET GAUCHE) ETAGERE
5010004124	220	LEFT OR RIGHT WOODY SIDE TABLE - TEXTURED DARK GREY	ETAGERE BOIS GAUCHE OU DROITE - GRAINE GRIS FONCE
5010004281	250	LEFT DOOR WITHOUT HANDLE - STAINLESS STEEL	PORTE GAUCHE SANS POIGNEE - INOX
5010004282	250	RIGHT DOOR WITHOUT HANDLE - STAINLESS STEEL	PORTE DROITE SANS POIGNEE - INOX
5010004285	170	SKIRT	JUPE
5010004287	250	RIGHT SIDE PANEL W/ LEGS (MOD. BEFORE 2018)	PANNEAU DROITE AVEC PIEDS (MOD. AVANT 2018)
5010004288	250	LEFT SIDE PANEL W/ LEGS (MOD. BEFORE 2018)	PANNEAU GAUCHE AVEC PIEDS (MOD. AVANT 2018)
5010004289	110	REAR PANEL	PANNEAU ARRIERE
5010004293	180	STAINLESS STEEL BURNER 28Mb	BRULEUR INOX 28Mb
5010004294	180	STAINLESS STEEL BURNER 50Mb	BRULEUR INOX 50Mb
5010004295	60	KNOB (X3)	VOLANT (X3)
5010004296	120	ENAMELLED STEEL HEAT DIFFUSER (X1)	DIFFUSEUR DE CHALEUR ACIER EMAILLE (X1)
5010004298	60	WINDSHIELD	PAREVENT
5010004300	800	STAINLESS STEEL LID WITH THERMOMETER	COUVERCLE INOX AVEC THERMOMETRE
5010004723	80	WARMING GRID (X2)	GRILLE DE MIJOTAGE (X2)
5010004726	290	KIT OF REMOVABLE PARTS (FIREBOX)	KIT DE PARTIES AMOVIBLES (CUVE)
5010004729	70	SET OF WHEELS (x2)	ENSEMBLE ROUES (x2)
5010004738	230	CHASSIS (MOD. 2017)	CHASSIS (MOD. 2017)
5010004748	150	BASE FRAME (MOD. BEFORE 2018)	CADRE SUPPORT DE CUVE (MOD. AVANT 2018)
5010004813	60	TOP FRONT PANEL WITH SHIELD (X2)	CONSOLE HAUT AVEC ECRAN THERMIQUE (X2)
5010004871	90	THERMOMETER WITH NUTS	THERMOMETRE AVEC ECROUS
5010004873	50	MAGNETS (X2)	AIMANTS (X2)
5010004926	50	CHROMED PLASTIC HANDLE (LEFT OR RIGHT) + SCREWS (MOD. BEFORE 2019)	POIGNEE PLASTIQUE CHROME (GAUCHE OU DROITE) + VIS (MOD. AVANT 2019)
5010004928	50	TROLLEY TOP REINFORCEMENT BAR	BARRE SUPERIEURE DE RENFORT CHARIOT
5010004931	50	LID PADS(x2) + BASE CUSHIONS(x2) + LEG GROMMETS(x4)	PATINS COUVERCLE(x2) + BOUCHONS CUVE(x2) + RONDELLES PIED(x4)
5010004949	250	CHASSIS (MOD. FROM 2018)	CHASSIS (MOD. A PARTIR DE 2018)
5010004950	210	LEFT SIDE PANEL W/ LEGS (MOD. 2018-2019)	PANNEAU GAUCHE AVEC PIEDS (MOD. 2018-2019)
5010004951	210	RIGHT SIDE PANEL W/ LEGS (MOD. 2018-2019)	PANNEAU DROITE AVEC PIEDS (MOD. 2018-2019)
5010004952	180	BASE FRAME (MOD. 2018)	CADRE SUPPORT DE CUVE (MOD. 2018)
5010005006	80	SCREW BAG	SACHET DE VIS
5010005336	230	ELECTRONIC IGNITION SET	KIT ALLUMAGE ELECTRONIQUE
5010005376	120	CHROMED STEEL HANDLE (LEFT OR RIGHT) + SCREWS (MOD. FROM 2019)	POIGNEE ACIER CHROME (GAUCHE OU DROITE) + VIS (MOD. A PARTIR DE 2019)
5010005377	250	ENAMELLED CAST IRON GRID (FRAME + CIRCLE) - MATTE (MOD. FROM 2019)	GRILLE FONTE EMAILLEE (CADRE + CERCLE) - MATE (MOD. A PARTIR DE 2019)
5010005390	250	BASE FRAME (MOD. FROM 2019)	CADRE SUPPORT DE CUVE (MOD. A PARTIR DE 2019)
5010005391	130	KIT OF ELECTRODES + HOUSINGS	KIT ELECTRODES + SUPPORTS
5010005395	60	STAINLESS STEEL HEAT DIFFUSOR (X1)	DIFFUSEUR DE CHALEUR INOX (X1)
5010005400	140	SMALL ENAMELLED CAST IRON GRID - MATTE (MOD. FROM 2019)	PETITE GRILLE DE CUISSON FONTE EMAILLEE - MATE (MOD. A PARTIR DE 2019)
5010005597	180	ELECTRONIC IGNITION SET (2/4 OUTLETS) WITH CONNECTION WIRES	KIT ALLUMAGE ELECTRONIQUE (2/4 SORTIES) AVEC CABLES DE CONNECTIONS

BARBECUE : MASTER 3 SERIES WOODY

SPARE PARTS REF.	POINTS	EN DESCRIPTIONS	FR DESCRIPTIONS
5010005624	540	CONTROL PANEL + WIRES (BACKLIGHTING+IGNITION) + STOVE PIPE 28Mb + HOSE	CONSOLE + CABLAGE (ECLAIRAGE+ALLUMAGE) + TUBULURE RECHAUD 28Mb + TUYAU
5010005638	450	CONTROL PANEL + WIRES (BACKLIGHTING + IGNITION) + PIPE 28Mb (Export)	CONSOLE + CABLAGE (ECLAIRAGE + ALLUMAGE) + TUBULURE 28Mb (Export)
5010005650	740	CONTROL PANEL + WIRES (BACKLIGHTING + IGNITION) + PIPE 50Mb (De) - PROPANE MODELS ONLY	CONSOLE + CABLAGE (ECLAIRAGE + ALLUMAGE) + TUBULURE 50Mb (De) - MODELES PROPANE UNIQUEMENT

5010005391

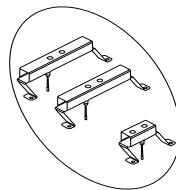

900 mm

1

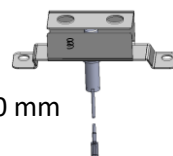

970 mm

2

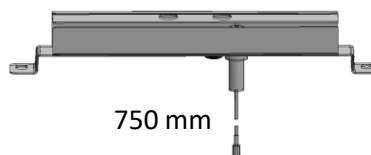

750 mm

