

**BARBECUE : MASTER 4 SERIES  
CLASSIC SBS (Mod. 2017-2018)**

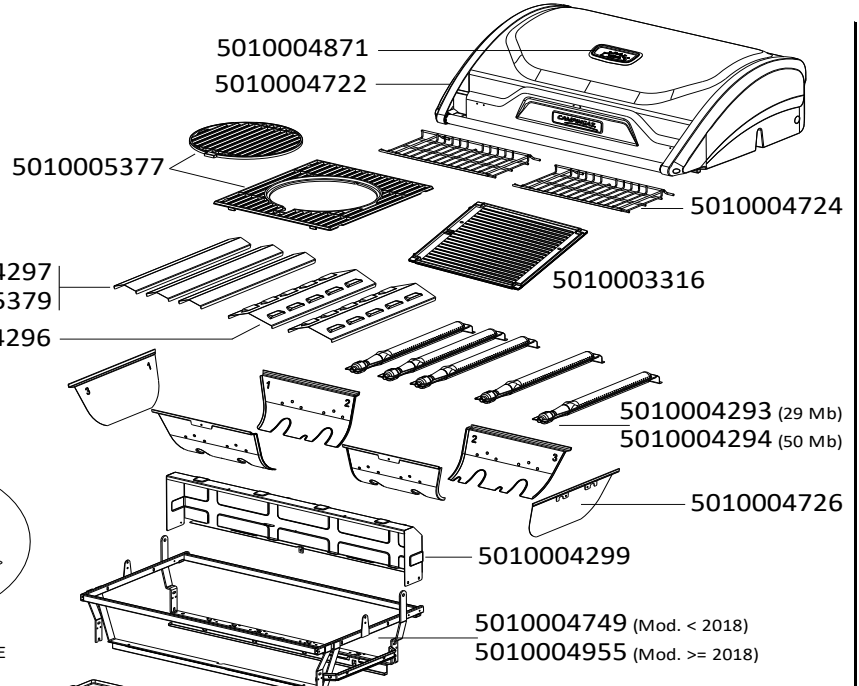

**BARBECUE : MASTER 4 SERIES  
CLASSIC SBS (Mod. 2017-2018)**



5010005642 (Exp.)  
5010005662 (Ch)  
5010005667 (De)  
Propane

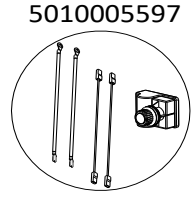
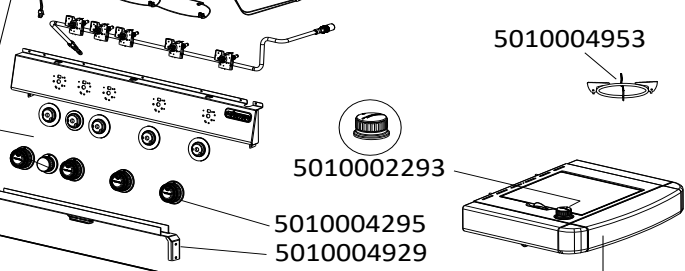
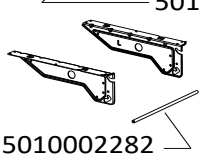
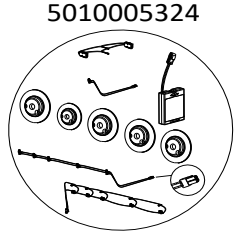
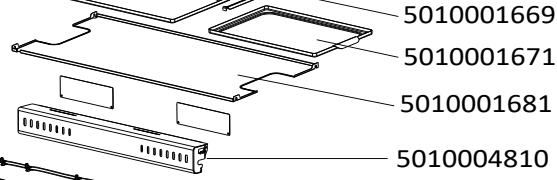
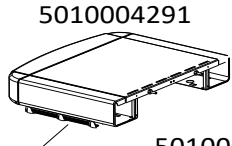

5010004956 (28 Mb Mod. < 2020)  
5010005625 (28 Mb Mod. >= 2020)  
5010005643 (50 Mb) - Propane

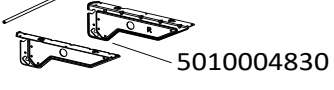
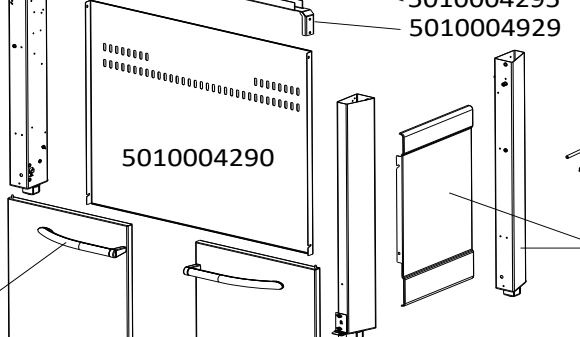
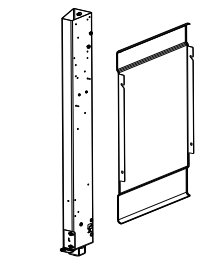

5010004926  
5010005376

**LEFT SIDE TROLLEY  
CHARIOT COTE GAUCHE**

**RIGHT SIDE TROLLEY  
CHARIOT COTE DROITE**

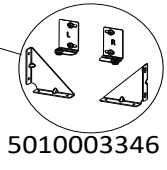
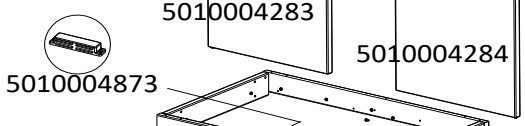
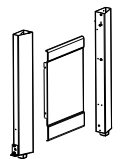
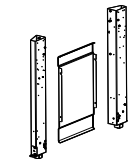

5010004288  
(Mod. 2017)

5010004287  
(Mod. 2017)

5010004950  
(Mod. >= 2018)

5010004951  
(Mod. >= 2018)

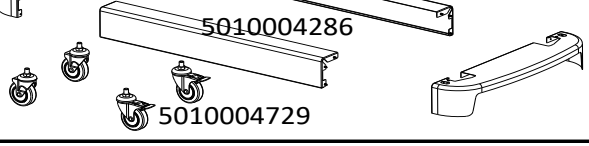
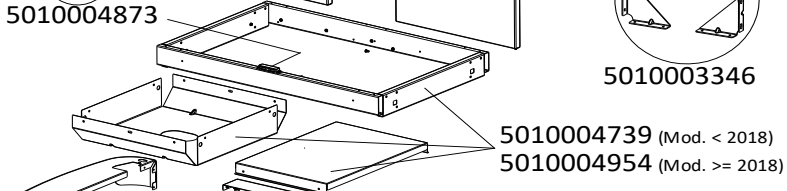

**SCREW BAG  
SACHET DE VIS  
5010005006**

# BARBECUE : MASTER 4 SERIES CLASSIC SBS (Mod. 2017-2018)

## GERÄTE FÜR DEUTSCHLAND UND ÖSTERREICH **WARNUNG!**

Gasgrillgeräte für Deutschland und Österreich können mit zwei verschiedenen Gasleitungen ausgestattet sein:  
 Butan und Propan (50 mbar)  
 Propan (50 mbar)

Um die für den Grill passende Gasleitung zu finden, schauen Sie bitte auf den am Grill angebrachten Aufkleber, der das



- Logo trägt (hinter der Rückwand angeordnet)

In der mit **DE. AT.** überschriebenen Sektion auf dem Aufkleber (siehe Bilder unten) finden Sie die Version der Gasleitung.

## MODELS FOR GERMANY AND AUSTRIA **WARNING!**

A barbecue used in Germany and Austria is using one of 2 types of gas pipe:

Butane and Propane (50 Mbar)  
 Propane (50 Mbar)

To find out the type of gas pipe used by a barbecue, see the CE sticker containing the logo (located behind the rear panel).

In the **DE. AT.** part of the CE label (see pictures below), you will find the type of gas pipe used.

## MODELES DESTINES A L'ALLEMAGNE ET L'AUTRICHE **ATTENTION !**

Un barbecue destiné à l'Allemagne et l'Autriche utilise un des 2 types de tubulure gaz :

Butane et propane à 50 mbar  
 Propane à 50 mbar

Pour reconnaître le type de tubulure gaz utilisé, consulter l'étiquette CE (placée derrière le panneau arrière) reconnaissable par le logo

Dans la partie **DE. AT.** de l'étiquette CE (voir les schémas ci-dessous) , le type de tubulure gaz est indiqué.

### Gasleitung nur für Propan - Propan gas pipe only - Tubulure gaz n'utilisant que le Propane

<p><b>FR - ATTENTION:</b> Des parties accessibles peuvent être très chaudes. Eloigner les jeunes enfants. A n'utiliser qu'à l'extérieur des locaux. Consulter la notice avant emploi.</p> <p><b>DE - ACHTUNG:</b> Die zugänglichen Teile am Grill können sehr heiß werden. Halten Sie Kinder davon fern. Nur im Freien benutzen. Vor Inbetriebnahme Gebrauchsanweisung lesen.</p> <p><b>IT - ATTENZIONE:</b> Alcune parti esposte possono riscaldarsi. Tenere lontano dalla portata dei bambini. Da utilizzarsi solo all'aria aperta. Leggere le istruzioni per l'uso prima di utilizzare l'apparecchio.</p>	
1312 - YY 1312 CO 5855	<p><b>DE. AT. CH:</b> Cat. I<sub>3BP (50)</sub> Propane (G31) 50mbar</p> <p><b>APPLICATION DES GAZ</b> 219, Route de Brignais - BP 55 ,69563 Saint Genis Laval - France</p>

### Gasleitung für Butan und Propan - Butan and Propan gas pipe - Tubulure gaz utilisant le Butane et le Propane

<p><b>FR - ATTENTION:</b> Des parties accessibles peuvent être très chaudes. Eloigner les jeunes enfants. A n'utiliser qu'à l'extérieur des locaux. Consulter la notice avant emploi.</p> <p><b>DE - ACHTUNG:</b> Die zugänglichen Teile am Grill können sehr heiß werden. Halten Sie Kinder davon fern. Nur im Freien benutzen. Vor Inbetriebnahme Gebrauchsanweisung lesen.</p> <p><b>IT - ATTENZIONE:</b> Alcune parti esposte possono riscaldarsi. Tenere lontano dalla portata dei bambini. Da utilizzarsi solo all'aria aperta. Leggere le istruzioni per l'uso prima di utilizzare l'apparecchio.</p>	
1312 - YY 1312 CO 5855	<p><b>DE. AT. CH:</b> Cat. I<sub>3BP (50)</sub> Butane (G30) 50 mbar - Propane (G31) 50 mbar</p> <p><b>APPLICATION DES GAZ</b> 219, Route de Brignais - BP 55 ,69563 Saint Genis Laval - France</p>

# BARBECUE : MASTER 4 SERIES

## CLASSIC SBS (Mod. 2017-2018)



SPARE PARTS REF.	POINTS	EN DESCRIPTIONS	FR DESCRIPTIONS
5010001669	30	GREASE DRAWER TENT	TENTE TIROIR RAMASSE GRAISSE
5010001671	50	GREASE PLATE (x1)	PLATEAU RAMASSE GRAISSE (x1)
5010001681	60	HEAT SHIELD	PARE CHALEUR
5010002192	40	USTENSIL HOOK	PORTE USTENSILES
5010002282	30	REINFORCEMENT WIRE SIDE SHELF	FIL RENFORT ETAGERE
5010002293	50	KNOB FOR SIDE STOVE	VOLANT POUR RECHAUD LATERAL
5010003316	260	REVERSIBLE ENAMELLED CAST IRON GRIDDLE - MATTE	PLAQUE DE CUISSON FONTE EMAILLEE REVERSIBLE - MATE
5010003346	40	AXLE SUPPORTS FOR DOORS (MOD. 2016 AND AFTER) + 2 CHASSIS SQUARES	SUPPORTS AXE PORTES (MOD. A PARTIR DE 2016) + 2 EQUERRES CHASSIS
5010004283	290	LEFT DOOR WITHOUT HANDLE - STAINLESS STEEL	PORTE GAUCHE SANS POIGNEE - INOX
5010004284	290	RIGHT DOOR WITHOUT HANDLE - STAINLESS STEEL	PORTE DROITE SANS POIGNEE - INOX
5010004286	190	SKIRT	JUPE
5010004287	250	RIGHT SIDE PANEL W/ LEGS (MOD. BEFORE 2018)	PANNEAU DROITE AVEC PIEDS (MOD. AVANT 2018)
5010004288	250	LEFT SIDE PANEL W/ LEGS (MOD. BEFORE 2018)	PANNEAU GAUCHE AVEC PIEDS (MOD. AVANT 2018)
5010004290	130	REAR PANEL	PANNEAU ARRIERE
5010004291	190	LEFT SIDE TABLE W/ USTENSIL HOOK	ETAGERE GAUCHE AVEC PORTE USTENSILES
5010004293	180	STAINLESS STEEL BURNER 28Mb	BRULEUR INOX 28Mb
5010004294	180	STAINLESS STEEL BURNER 50Mb	BRULEUR INOX 50Mb
5010004295	60	KNOB (X3)	VOLANT (X3)
5010004296	120	ENAMELLED STEEL HEAT DIFFUSER (X1)	DIFFUSEUR DE CHALEUR ACIER EMAILLE (X1)
5010004297	40	ENAMELLED HEAT DIFFUSER (BLACK) (X1)	DIFFUSEUR DE CHALEUR EMAILLE (NOIR) (X1)
5010004299	80	WINDSHIELD (BLACK)	PAREVENT (NOIR)
5010004722	900	STAINLESS STEEL LID WITH THERMOMETER	COUVERCLE INOX AVEC THERMOMETRE
5010004724	90	WARMING GRID (X2)	GRILLE DE MIJOTAGE (X2)
5010004726	290	KIT OF REMOVABLE PARTS (FIREBOX)	KIT DE PARTIES AMOVIBLES (CUVE)
5010004729	70	SET OF WHEELS (x2)	ENSEMBLE ROUES (x2)
5010004739	250	CHASSIS (MOD. 2017)	CHASSIS (MOD. 2017)
5010004749	180	BASE FRAME (MOD. BEFORE 2018)	CADRE SUPPORT DE CUVE (MOD. AVANT 2018)
5010004810	60	TOP FRONT PANEL WITH SHIELD (X2)	CONSOLE HAUT AVEC ECRAN THERMIQUE (X2)
5010004830	60	SIDE SHELF SUPPORTS (RIGHT AND LEFT) - TEXTURED DARK GREY	SUPPORTS ETAGERE (DROITE ET GAUCHE) - GRAINE GRIS FONCE
5010004871	90	THERMOMETER WITH NUTS	THERMOMETRE AVEC ECROUS
5010004873	50	MAGNETS (X2)	AIMANTS (X2)
5010004874	50	PROBE FOR THERMOMETER	SONDE POUR THERMOMETRE
5010004926	50	CHROMED PLASTIC HANDLE (LEFT OR RIGHT) + SCREWS (MOD. BEFORE 2019)	POIGNEE PLASTIQUE CHROME (GAUCHE OU DROITE) + VIS (MOD. AVANT 2019)
5010004929	50	TROLLEY TOP REINFORCEMENT BAR	BARRE SUPERIEURE DE RENFORT CHARIOT
5010004931	50	LID PADS(x2) + BASE CUSHIONS(x2) + LEG GROMMETS(x4)	PATINS COUVERCLE(x2) + BOUCHONS CUVE(x2) + RONDELLES PIED(x4)
5010004950	210	LEFT SIDE PANEL W/ LEGS (MOD. 2018-2019)	PANNEAU GAUCHE AVEC PIEDS (MOD. 2018-2019)
5010004951	210	RIGHT SIDE PANEL W/ LEGS (MOD. 2018-2019)	PANNEAU DROITE AVEC PIEDS (MOD. 2018-2019)
5010004953	60	SIDE STOVE PAN SUPPORT	SUPPORT DE CASSEROLE RECHAUD LATERAL
5010004954	250	CHASSIS (MOD. FROM 2018)	CHASSIS (MOD. A PARTIR DE 2018)
5010004955	210	BASE FRAME (MOD. FROM 2018)	CADRE SUPPORT DE CUVE (MOD. A PARTIR DE 2018)
5010004956	610	SIDE BURNER TABLE WITH STAINLESS STEEL GAS PIPE 28Mb	ETAGERE RECHAUD LATERAL AVEC TUBULURE INOX 28Mb

**BARBECUE : MASTER 4 SERIES  
CLASSIC SBS (Mod. 2017-2018)**

SPARE PARTS REF.	POINTS	EN DESCRIPTIONS	FR DESCRIPTIONS
5010005006	80	SCREW BAG	SACHET DE VIS
5010005324	290	ELECTRONIC IGNITION SET	KIT ALLUMAGE ELECTRONIQUE
5010005376	120	CHROMED STEEL HANDLE (LEFT OR RIGHT) + SCREWS (MOD. FROM 2019)	POIGNEE ACIER CHROME (GAUCHE OU DROITE) + VIS (MOD. A PARTIR DE 2019)
5010005377	250	ENAMELLED CAST IRON GRID (FRAME + CIRCLE) - MATTE (MOD. FROM 2019)	GRILLE FONTE EMAILLEE (CADRE + CERCLE) - MATE (MOD. A PARTIR DE 2019)
5010005379	50	STAINLESS STEEL HEAT DIFFUSEUR (X1)	DIFFUSEUR DE CHALEUR INOX (X1)
5010005392	180	KIT OF ELECTRODES + HOUSINGS	KIT ELECTRODES + SUPPORTS
5010005597	180	ELECTRONIC IGNITION SET (2/4 OUTLETS) WITH CONNECTION WIRES	KIT ALLUMAGE ELECTRONIQUE (2/4 SORTIES) AVEC CABLES DE CONNECTIONS
5010005625	600	SIDE BURNER TABLE WITH STAINLESS STEEL GAS PIPE 28Mb	ETAGERE RECHAUD LATERAL AVEC TUBULURE INOX 28Mb
5010005642	600	CONTROL PANEL + WIRES (BACKLIGHTING+IGNITION) + STOVE PIPE 28Mb (Export)	CONSOLE + CABLAGE (ECLAIRAGE+IGNITION) + TUBULURE RECHAUD 28Mb (Export)
5010005643	590	SIDE BURNER TABLE WITH STAINLESS STEEL GAS PIPE 50Mb (De) - PROPANE MODELS ONLY	ETAGERE RECHAUD LATERAL AVEC TUBULURE INOX 50Mb (De) - MODELES PROPANE UNIQUEMENT
5010005662	710	CONTROL PANEL + WIRES (BACKLIGHTING+IGNITION) + STOVE PIPE 28Mb 1/4"(Ch)	CONSOLE + CABLAGE (ECLAIRAGE+ALLUMAGE) + TUBULURE RECHAUD 28Mb 1/4"(Ch)
5010005667	860	CONTROL PANEL + WIRES (BACKLIGHTING+IGNITION) + STOVE PIPE 50Mb 1/4"(De) - PROPANE MODELS ONLY	CONSOLE + CABLAGE (ECLAIRAGE+ALLUMAGE) + TUBULURE RECHAUD 50Mb 1/4"(De) - MODELES PROPANE UNIQUEMENT

**KIT OF ELECTRODES + HOUSINGS / KIT ELECTRODES + SUPPORTS  
5010005392**

See last page / Voir dernière page

**BARBECUE : MASTER 4 SERIES**  
**CLASSIC SBS (Mod. 2017-2018)**

5010005392

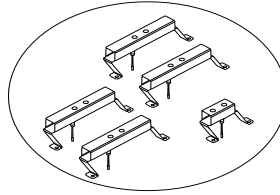

**1**

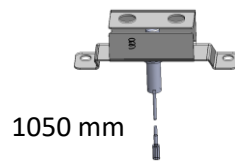

1050 mm

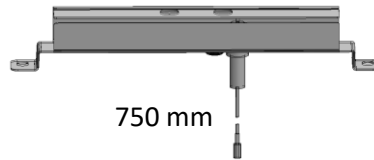

750 mm

**3**

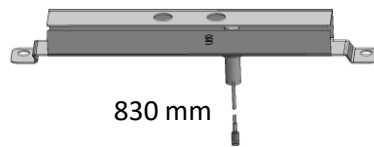

830 mm

**2**

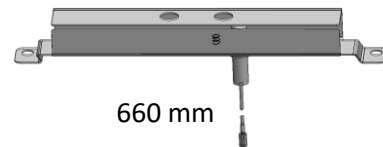

660 mm

