

**Step 5**

Connect wall panel zip to the roof and base, zips start under Velcro flaps.

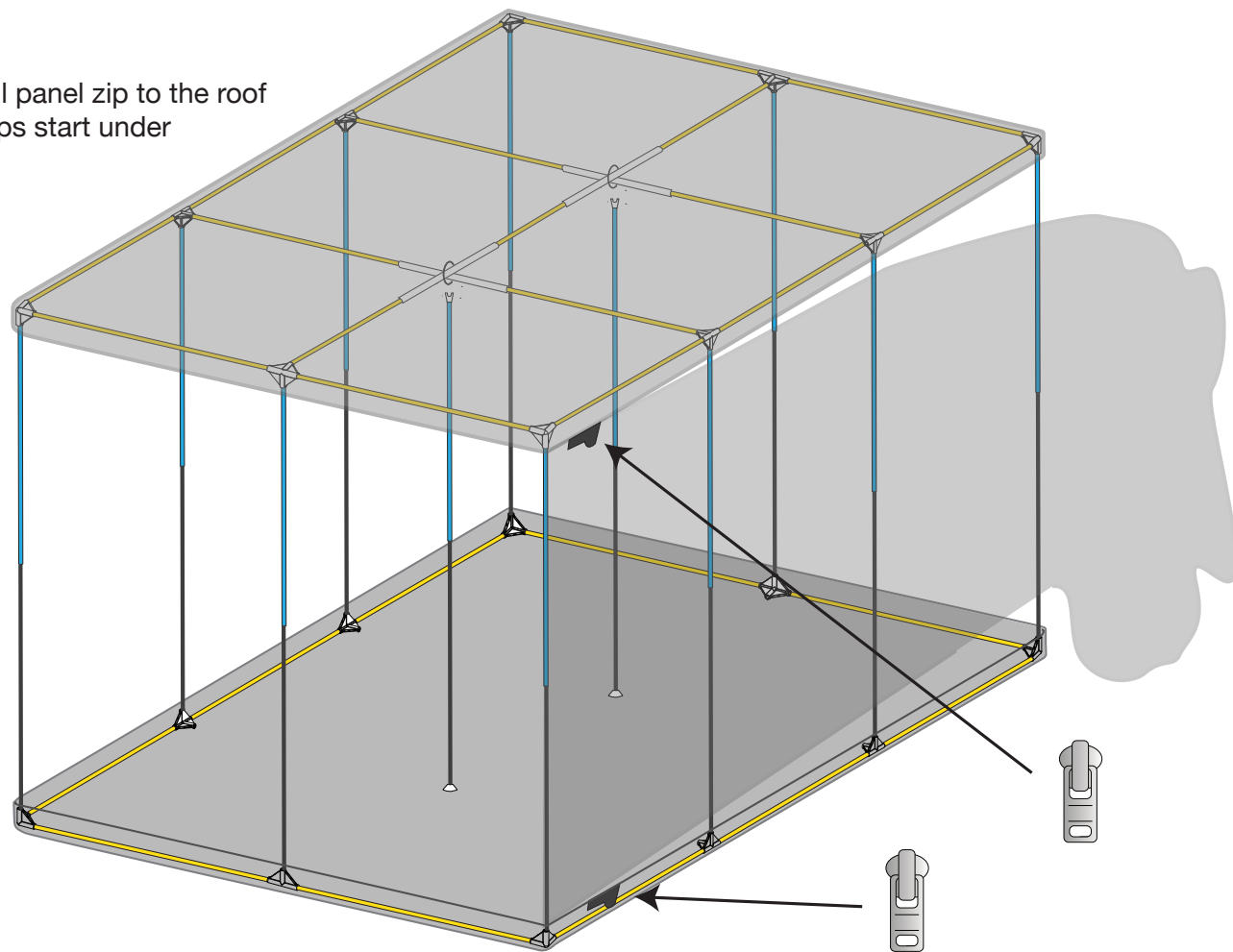

**Step 6**

Zip the wall panel to the roof and base. Fit equipment hanger ends to poles. Position equipment hangers as required.

Equipment Hanger End

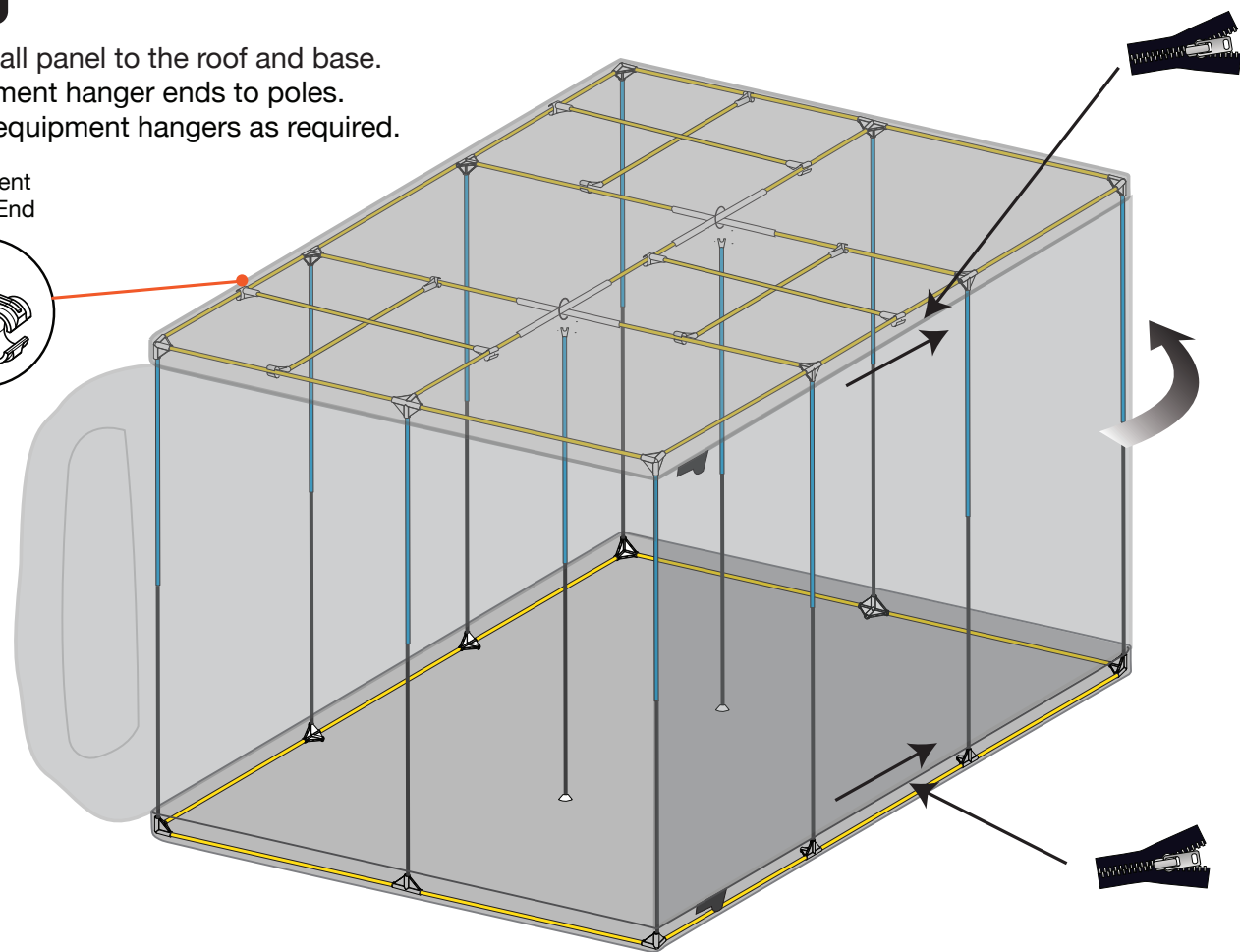
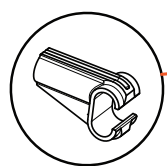

**Assembly Instructions**

Two Person Assembly







  
mammothtents.nl  
**Elite 360S SA**

# Mammoth Elite 360S SA Assembly Guide

Equipment Hangers

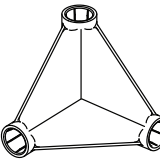
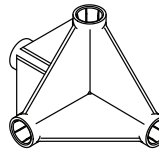
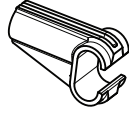

**Parts List**

-  Yellow Pole x33
-  Blue Pole x12
-  Black Pole x12
-  3-Way Corner x8
-  4-Way Join x12
-  Equipment Hanger Ends x12
-  Support Pole Rubber Foot x2
-  Support Pole Rubber Top x2
-  Straight Pole Connectors x4
-  Centre Securing Ring x2

### Step 1

Organise poles and connectors into their colours and groups.  
Unzip and lay out tent.  
Locate floor section and lay flat with edge sections vertical.  
Assemble floor poles and 3-way corners and 4-way Joins as shown.  
Ensure Velcro flap is in front right corner.

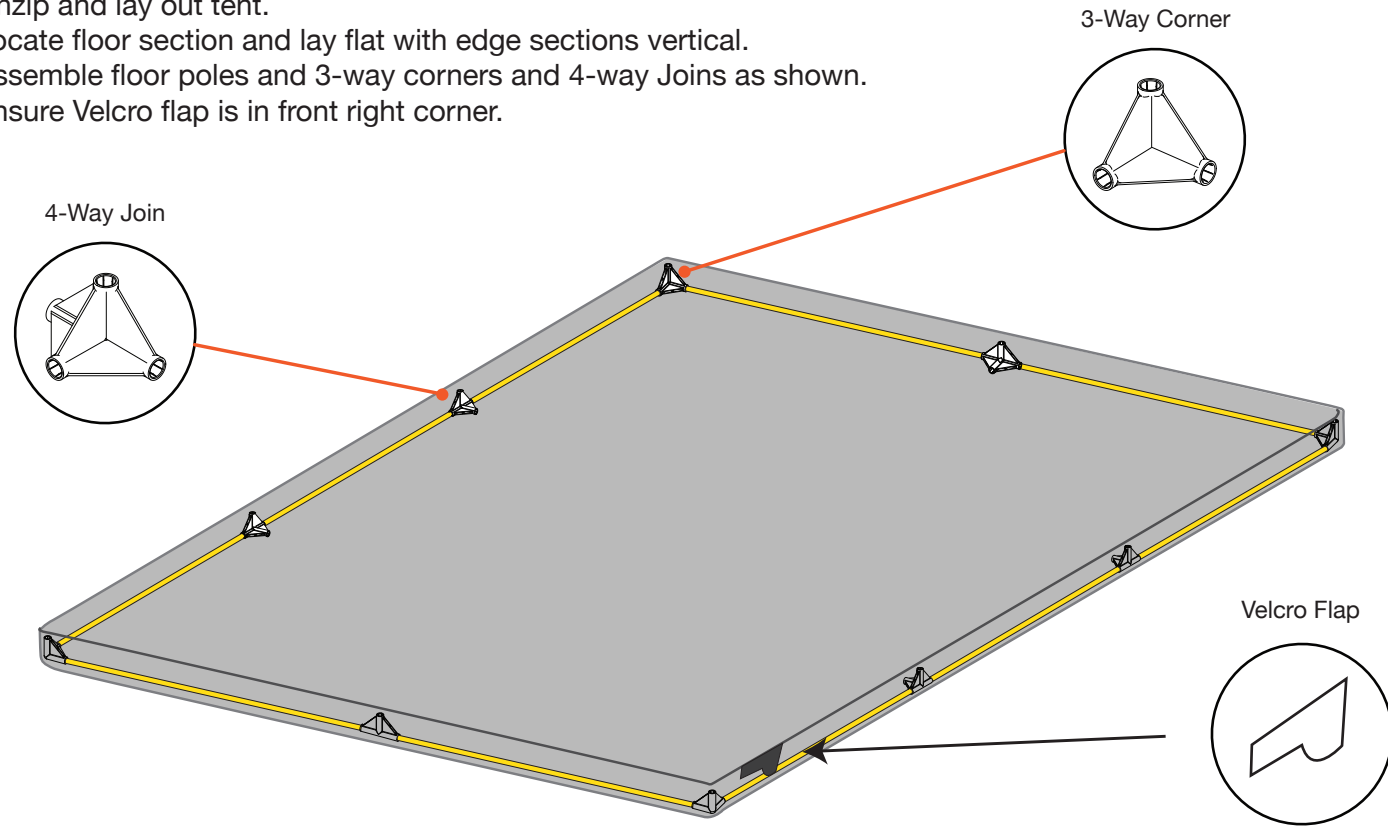

### Step 3

Insert ceiling poles into 3-way corners and 4-Way joins.  
Fit centre securing ring over pole before fitting to 4-way join.  
Fit centre ceiling poles into straight pole connectors.

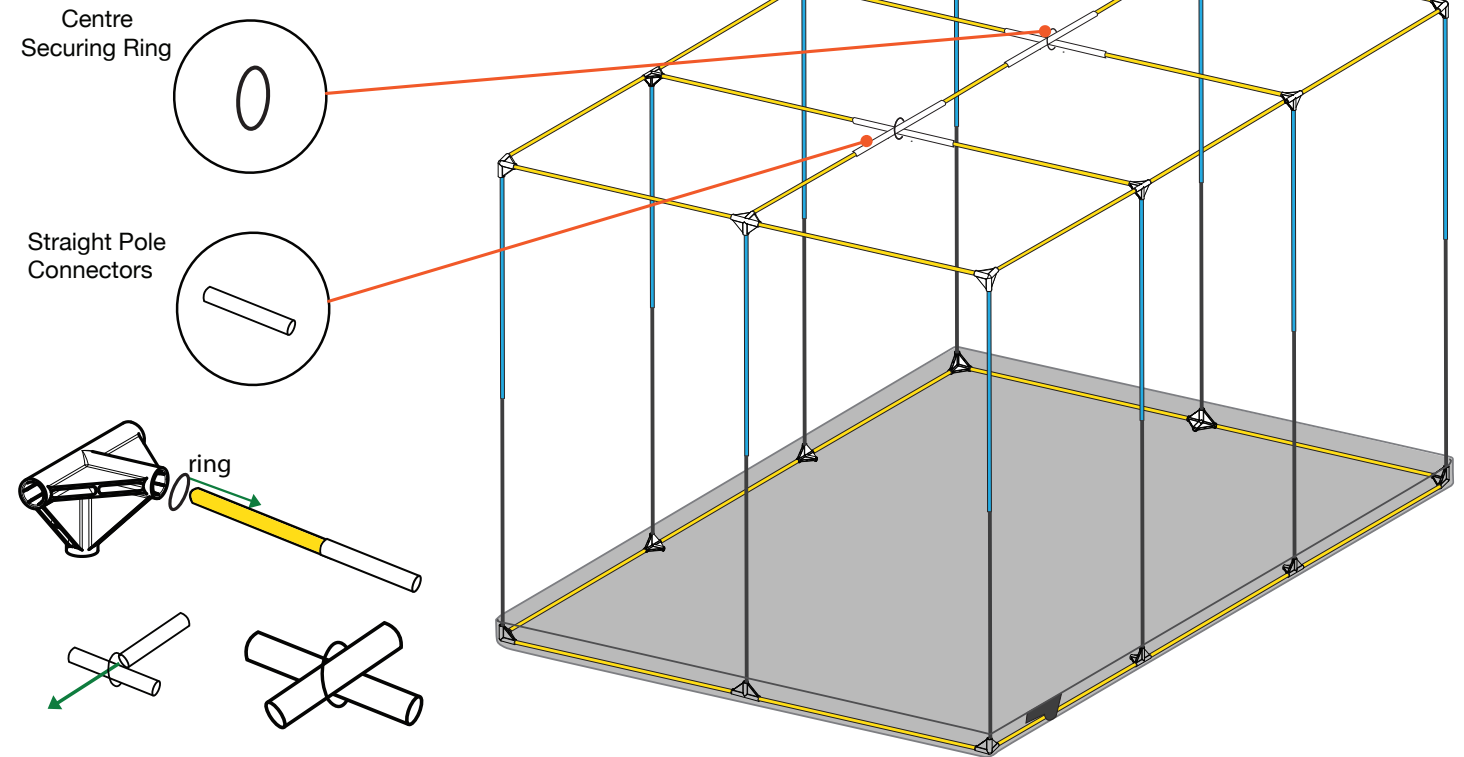

### Step 2

Insert lower wall poles (chamfered end) into 3-way corners and 4-way Join.  
Insert upper wall poles (shrunk end) into lower poles.  
Fit 3-way corners and 4-way joins on top.

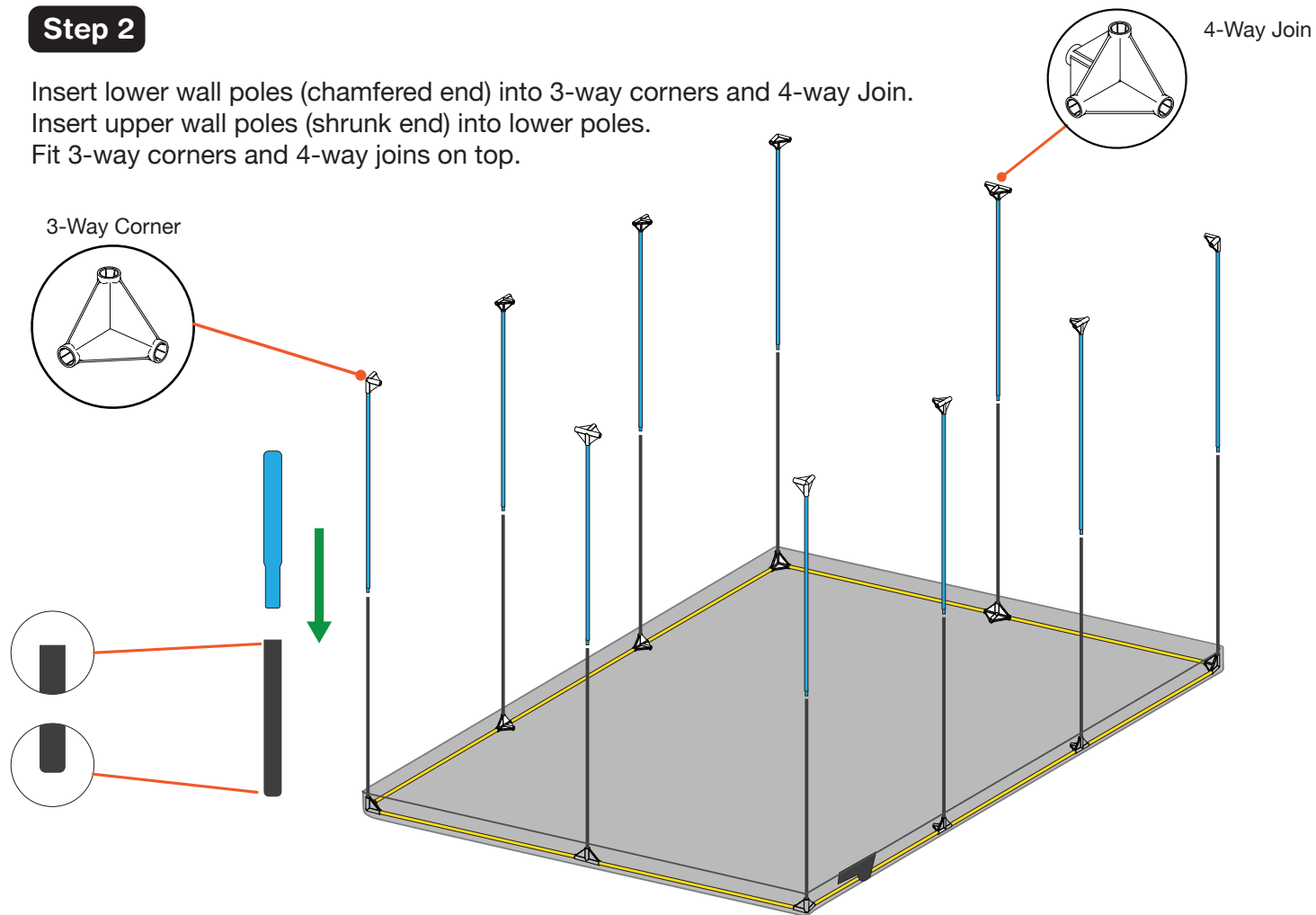

### Step 4

Fit support poles.  
Fit roof ensuring Velcro flap is in front right corner.

