

PRODUCT DATASHEET

FL PFM 65W 4000 K SYM 100 SL BK

FLOODLIGHT PHOTOCELL 65 W | Floodlight with daylight sensor, 65 W power consumption



Areas of application

- Replacement for floodlights with halogen lamps
- Outdoor use (IP65)
- Industry
- Public areas
- Construction areas
- Building facades

Product benefits

- Bright, robust and durable
- Automatically switches on and off according to the amount of available daylight
- Always-on override, activated via special mains switching pattern
- Safe and very uniform illumination, due to frosted and tempered glass diffuser
- No upper light output ratio (ULOR 0%) when mounted at 0° tilt
- Energy savings of up to 90 % compared to halogen lamp floodlights
- 5 years guarantee

Product features

- Daylight sensor, integrated in glass cover
- Switch on below 35 lux, switch off above 95 lux illuminance
- Reflector-based, symmetric light distribution with 100° x 100° beam angle
- Integrated wide voltage driver, suitable for 100 - 277 V AC
- Surge protection: up to 6 kV (L/N-PE), 4 kV (L-N)
- Mounting bracket with 30° angle and wide rotation area



- Breather membrane to optimize air exchange, without compromising IP protection
- Pre-installed, flexible 1 m cable (H05RN-F), wrapped 3 x 1.0 mm² single wires

TECHNICAL DATA

Electrical data

Nominal wattage	65.00 W
Nominal voltage	100...277 V
Mains frequency	50...60 Hz
Nominal current	340 mA
Inrush current	14.1 A
Inrush current time T_{h50}	145 μ s
Max. number of luminaires per miniature circuit breaker B16	29
Max. number of luminaires per miniature circuit breaker C10	21
Max. number of luminaires per miniature circuit breaker C16	33
Power factor λ	> 0.90
Total harmonic distortion	< 20 %
Protection class	I
Operating mode	Integrated LED driver

Photometrical data

Luminous flux	8000 lm
Luminous efficacy	125 lm/W
Color temperature	4000 K
Light color (designation)	Cool White
Color rendering index Ra	\geq 80
Standard deviation of color matching	\leq 5 sdc _m
Luminous intensity	-
Flickering metric (Pst LM)	-
Stroboscope effect metric (SVM)	-
Photobiological safety group acc. to EN62778	RG1
Photobiological safety group acc. to EN62471	RG1
Beam angle	100 ° x 100 °

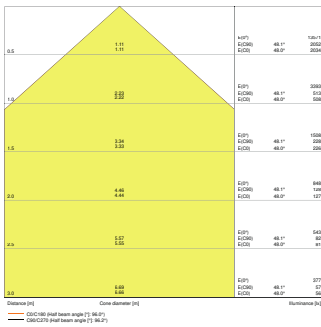

FL PFM 65W4000K SYM100SL BK

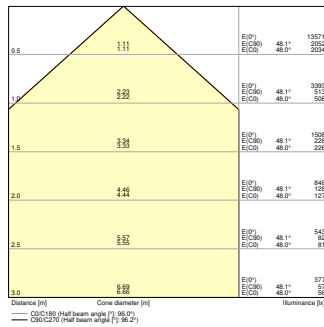

FL PFM 65W 4000K SYM100SL BK

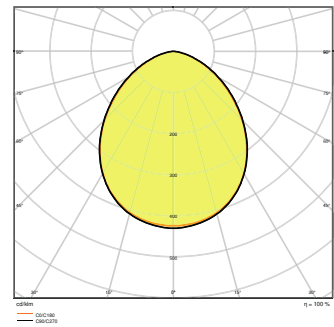

FL PFM 65W4000K SYM100SL BK

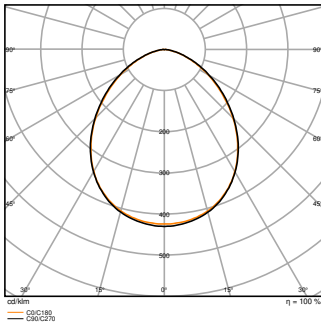

FL PFM 65W 4000K SYM100SL BK

Dimensions & Weight

Length	268.00 mm
Width	237.00 mm
Height	49.00 mm
Product weight	2100.00 g
Cable length	1000 mm

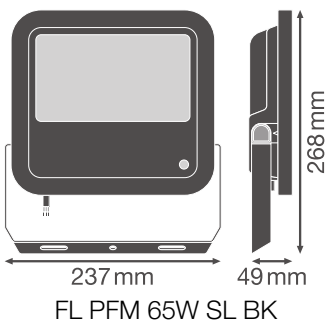

Materials & Colors

Product color	Black
Housing color	Black
Body material	Aluminum
Light emitting surface material	Glass
Glow Wire Test according to IEC 60695-2-12	650 °C
Mercury content	0.0 mg

Application & Mounting

Ambient temperature range	-30...+50 °C
Temperature range at storage	-40...+70 °C
Type of connection	Cable, 3-pole
Type of protection	IP65
Protection class IK (shock resistance)	IK08
Dimmable	No
Mounting type	Surface
Mounting location	Wall / Pole / Floor
Application environment	Outdoor
Adjustable	Yes
LED module replaceable	Not replaceable
With light source	Yes

Lifespan

Lifespan L70/B50 at 25 °C	70000 h ¹⁾
Lifespan L80/B10 at 25 °C	55000 h ¹⁾
Lifespan L90/B10 at 25 °C	35000 h
Number of switching cycles	100000

¹⁾ t[h]: L70 / B50 @ 25 °C (Ta), t[h]: L80 / B10 @ 25 °C (Ta), t[h]: L90 / B10 @ 25 °C (Ta)

Control gear

Output current	700 mA
ECG - Output ripple current	< 35 %

Sensor

Type of sensor	Light
Sensor technology	Photocell
Detection threshold of daylight sensor	35...95 lx

Sensor IP rating	IP65
------------------	------







Certificates & Standards



Standards	CE / CB / ENEC / EAC / EPD
Luminaire with limited surface temperature, "D sign"	No
Ball shot safe	No
EPD	LEDV-00017-V01.01-EN









Safety advice



– Max. wind load surface 0.046 m²

DOWNLOAD DATA

Documents and certificates		Document name
	User Instruction	FLOODLIGHT PHOTOCELL 65W - 200W
	Legal information	Legal insert
	Legal information	LSI FL PFM SYM
	Legal information	Legal Insert FL PFM
	Legal information	Informationstext 18 Abs 4 ElektroG
	Declarations of conformity	FL PFM SYM SL BK
	Declarations Of Conformity UKCA	FL PFM 4000K SYM100SL BK

Photometric and lighting design files		Document name
	IES file (IES)	FL PFM 65W4000K SYM100SL BK
	IES file (IES)	FL PFM 65W 4000K SYM100SL BK
	LDT file (Eulumdat)	FL PFM 65W4000K SYM100SL BK

Photometric and lighting design files		Document name
	LDT file (Eulumdat)	FL PFM 65W 4000K SYM100SL BK
	ULD file (DIALux)	FL PFM 65W-4000K SYM100SL BK
	ROLF file (RELUX)	FL PFM 65W-4000K
	UGR file (UGR table)	FL PFM 65W4000K SYM100SL BK
	UGR file (UGR table)	FL PFM 65W 4000K SYM100SL BK
	LDC typ cone	FL PFM 65W4000K SYM100SL BK
	LDC typ cone	FL PFM 65W 4000K SYM100SL BK
	LDC typ polar	FL PFM 65W4000K SYM100SL BK
	LDC typ polar	FL PFM 65W 4000K SYM100SL BK

CAD/BIM files		Document name
	BIM_Revit_3D	Floodlight Photocell G3
	CAD_STEP_3D	FL G3 65W

Tender texts		Document name
	Tender documents	FLOODLIGHT PHOTOCCELL 65 W 4000 K SYM 100 SL BK-EN

LOGISTICAL DATA

Product code	Packaging unit (Pieces/Unit)	Dimensions (length x width x height)	Gross weight	Volume
4058075461093	Folding box 1	56 mm x 244 mm x 285 mm	2224.00 g	3.89 dm ³
4058075461109	Shipping box 4	289 mm x 274 mm x 347 mm	9413.00 g	27.48 dm ³

The mentioned product code describes the smallest quantity unit which can be ordered. One shipping unit can contain one or more single products. When placing an order, for the quantity please enter single or multiples of a shipping unit.

ADDITIONAL CATALOG INFORMATION

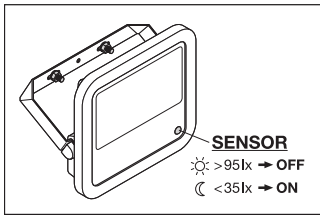

	A	B	C	⚙️	📏
65W	150	108	8.5	2x M8	0.046 m²
80W	150	108	10.5	2x M10	0.061 m²
125W	170	118	10.5	2x M10	0.083 m²
165W	170	118	12.5	2x M12	0.102 m²
200W	170	118	12.5	2x M12	0.124 m²

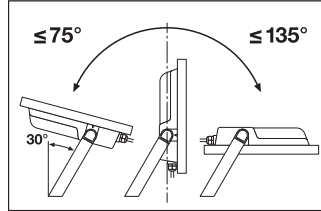
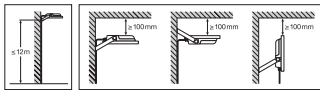
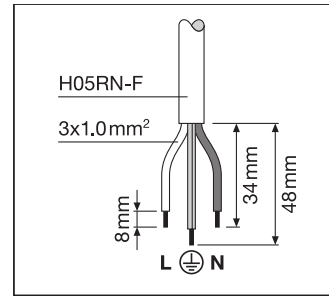

References / Links

– For Guarantee see www.ledvance.com/guarantee

DISCLAIMER

Subject to change without notice. Errors and omission excepted. Always make sure to use the most recent release.