

Ledvion

INFRARED MOTION SENSOR

White motion sensor

5692 DH Son en Breugel
Ekkersrijt 4304
The Netherlands
www.ledvion.com

220-240V/AC | 50/60Hz
IP65 | <3-2000LUX (adjustable)



LV10033 & LV10034

SPECIFICATIONS & FUNCTIONS

THE LEDVION INFRARED MOTION SENSOR

The product adopts good sensitivity detector and integrated circuit. It gathers automatism, convenience, safety, saving-energy and practical functions. It utilizes the infrared energy from humans to use it as control-signal source and it can start the load at once when a human enters the detection field. It can identify day and night automatically. It is easy to install and use widely.

SPECIFICATIONS

- Voltage: 220-240V/AC
- Power frequency: 50/60Hz
- Ambient light: <3 - 2000 LUX (adjustable)
- Time delay: min. 10 sec ± 3 sec
max. 15 min ± 2 min
- Rated load: max. 1200W 
max. 600W 
- IP class: IP65
- Detection range: 180°/360°
- Detection distance: 12m max (<24°C)
- Working temperature: -20 + 40°C
- Working humidity: <93%RH
- Power consumption: approx 0.5W
- Installation height: 1.8 - 2.5m
- Detection moving speed: 0.6 - 1.5m/s

FUNCTIONS

- Can identify day and night: the consume rcan adjust working state in different ambient light. It can work in the daytime and at night when it is adjusted on the 'sun' position (max). It can work in the ambient light when it is less then 3 LUX when it is adjusted on the '3' position (min). As for the adjustment pattern, please refer to the testing pattern.
- Time-delay is added continually: when it receives the second induction signals within the first induction, it will restart to the time from the moment.

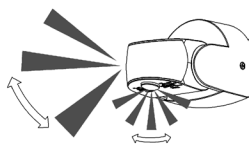

Good sensitivity

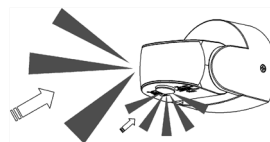

Poor sensitivity

INSTALLATION, INFORMATION & TESTING

INSTALLATION ADVICE

As the detector responds to changes in temperature, avoid the following situations

- Avoid pointing the detector towards objects with highly reflective surfaces, such as mirrors etc.
- Avoid mounting the detector near heat sources, such as heating vents, air conditioning units, light etc.
- Avoid pointing the detector towards objects that may move in the wind, such as curtains, tall plants etc.

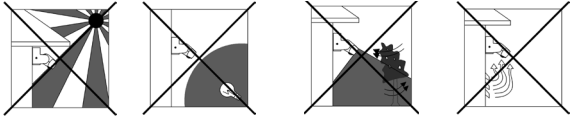

Warning. Danger of death through electric shock!

- Must be installed by a professional electrician
- Disconnect power source
- Cover or shield any adjacent live components
- Ensure that the device cannot be switched on
- Check power supply is disconnected

CONNECTION

- Loosen the screw on the bottom and unload the bottom.
- Pass the power wire through the hole with gasket in the bottom. Connect the power wire into the connection-wire column according to the connection-wire diagram.
- Fix the bottom with inflated screw on the selected position (refer to the figure)
- Install back the sensor on the bottom, tighten the screw and then test it.
- It not only can be installed on the wall directly but can also be installed on the ceiling (refer to the photo below):



Wall installation



Ceiling installation

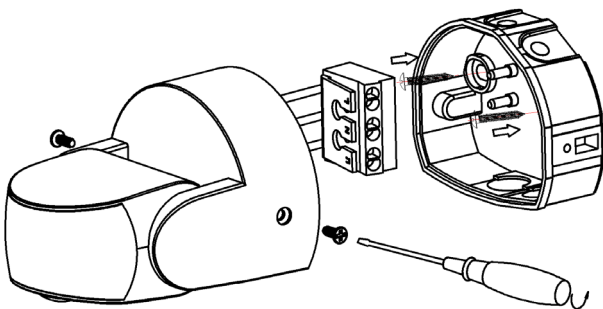

TEST

- Turn the LUX knob clockwise on the maximum (sun). Turn the TIME knob anti-clockwise on the minimum (10s).
- Switch on the power, the sensor and its connected lamp will have no signal at the beginning. After warm-up 30 sec, the sensor can start to work. If the sensor receives the induction signal, the lamp will turn on. While there is no another induction signal, the lamp will turn on. While there is not another induction signal anymore, the load should stop working within 10 sec \pm 3 sec and the lamp will turn off.

- Turn the LUX knob anti-clockwise on the minimum (3). If the ambient light is more than 3 LUX, the sensor will not work and the lamp will stop working too. If the ambient light is less than 3 LUX (darkness), the sensor will work. Under no induction signal condition, the sensor should stop working within 10 sec \pm 3 sec.

Note: when testing in daylight, please turn the LUX knob to the (SUN) position, otherwise the sensor lamp could not work!

SENSOR INFORMATION

It can detect the front side, bottom side and back side

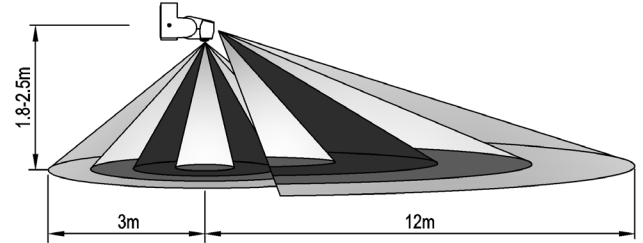

PROBLEMS & SOLUTIONS

- The load does not work:
 - Please check if the connection of the power source and load is correct.
 - Please check if the load is good.
 - Please check if the settings of the working light correspond to the ambient light.
- The sensitivity is poor:
 - Please check if there is any hindrance in front of the detector to affect it to receive the signals.
 - Please check if the ambient temperature is too high.
 - Please check if the induction signal source is in the detection field.
 - Please check if the installation height corresponds to the height required in the instruction.
 - Please check if the moving orientation is correct.
- The sensor can not shut off the load automatically:
 - Please check if there is continual signal in the detection field.
 - Please check if the time delay is set to the maximum position.
 - Please check if the power corresponds to the instruction.

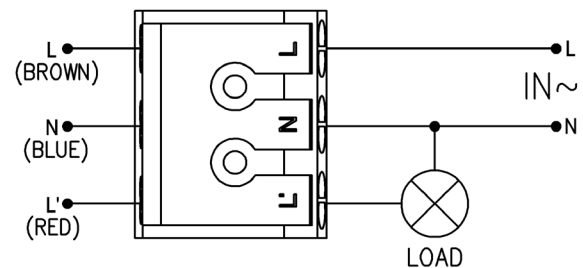

Connection-wire diagram

