

# Ledvion

## FLOODLIGHT

Floodlight + easy connector

5692 DH Son en Breugel  
Ekkersrijt 4304  
The Netherlands  
[www.ledvion.com](http://www.ledvion.com)

LV50015, LV50016, LV50017, LV50018  
LV50019, LV50020, LV50021 & LV50022

### EN INSTALLATION INSTRUCTIONS:

#### Attention

Installation should only be done by persons with electro technical knowledge and experience. These products are not suitable for installation at locations near the sea or in other environments with a corrosive atmosphere.

1. Ensure that the main power source is turned off.
2. Connect the device to the mains supply with the terminal block.
3. Make sure that the cables are connected securely to the terminals on the device.
4. When installation is finished, activate the power source and test the function.

### NL INSTALLATIE INSTRUCTIES

#### Attentie

Installatie dient door een erkende installateur te worden verricht in overeenstemming met plaatselijke en (inter)nationale voorschriften voor elektrische installaties. Niet geschikt voor installatie op locaties dicht bij de zee of in overige omgevingen met een corrosieve atmosfeer.

1. Schakel de netspanning uit voordat er begonnen wordt met de installatie en/of onderhoud.
2. Bevestig de netspanningskabel aan de aansluitblok van het product.
3. Zorg voor een correcte verbinding van de kabels met de aansluitklemmen.
4. Nadat de installatie is afgesloten, de zekering weer inschakelen en de functie testen.

### ES INSTRUCCIONES DE INSTALACIÓN

#### Atención

Instalación sólo para personas con conocimientos técnicos de electricidad y experiencia. No es adecuado para su instalación en lugares cercanos al mar o en otros ambientes con una atmósfera corrosiva.

1. Asegúrese de que la fuente de alimentación principal esté apagada.
2. Conecte el aparato a la red eléctrica mediante la regleta de terminales.
3. Asegúrese de que los cables estén bien conectados a los terminales en el dispositivo.
4. Cuando termine la instalación, active la fuente de energía y pruebe el funcionamiento.

### DE INSTALLATIONSANLEITUNG

#### Beachtung

Die Installation sollte nur durch Personen mit elektronischen Kenntnissen und Erfahrungen ausgeführt werden. Nicht geeignet für die Installation an Orten nahe am Meer oder in anderen Bereichen mit einer korrosiven Atmosphäre.

1. Stellen Sie sicher, dass die Anschlussleitungen Spannungsfrei sind, dazu Sicherung ausschalten und gegen Wiedereinschalten sichern.
2. Verbinden Sie die die Leitungen L (Braun oder Schwarz), N (Blau) und Grün/Gelb mit den dafür vorgesehenen Anschlussklemmen.
3. Nach abgeschlossener Installation, die Sicherung wieder einschalten und die Funktion überprüfen.
4. Wenn die Installation abgeschlossen ist, aktivieren Sie die Stromquelle und testen Sie die Funktion.

### FR NOTICE D'INSTALLATION

#### Attention

L'installation ne doit être effectuée que par des personnes possédant des connaissances et de l'expérience en électrotechnique. Ne convient pas pour une installation dans des endroits à proximité de la mer ou dans d'autres zones avec une atmosphère corrosive.

1. Mettre hors tension les câbles de connection et s'assurer, en coupant le courant au compteur, qu'ils le restent le temps de l'installation.
2. Veillez un contact propre entre le cable d'alimentation et les pinces de l'appareil.
3. Assurez-vous que les câbles sont correctement connectés aux bornes de l'appareil.
4. Lorsque l'installation est terminée, activez la source d'alimentation et testez la fonction.

# Ledvion

FLOODLIGHTS

**Ledvion**

Ekkersrijt 4304  
5692 DH Son en Breugel  
The Netherlands



INCLUDED:

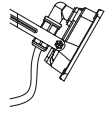

+ EASY  
CONNECTOR

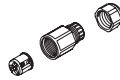

[www.ledvion.com](http://www.ledvion.com)

## TECHNICAL DATA:

Model	Voltage	Power/Wattage	Lumen	Tempered Glass	Maximum projected area	Net weight
LV50015	AC220-240V	10W	850LM	97.2*72.2*3.2mm	35 cm <sup>2</sup>	0.29 kg
LV50016	AC220-240V	10W	850LM	97.2*72.2*3.2mm	35 cm <sup>2</sup>	0.29 kg
LV50017	AC220-240V	30W	2550LM	144.4*104.4*3.2mm	88 cm <sup>2</sup>	0.55 kg
LV50018	AC220-240V	30W	2550LM	144.4*104.4*3.2mm	88 cm <sup>2</sup>	0.55 kg
LV50019	AC220-240V	50W	4250LM	175.8*125.8*3.2mm	130 cm <sup>2</sup>	0.76 kg
LV50020	AC220-240V	50W	4250LM	175.8*125.8*3.2mm	130 cm <sup>2</sup>	0.76 kg
LV50021	AC220-240V	100W	8500LM	235.8*168.8*3.2mm	268 cm <sup>2</sup>	1.43 kg
LV50022	AC220-240V	100W	8500LM	235.8*168.8*3.2mm	268 cm <sup>2</sup>	1.43 kg

The minimum distance from lighted objects is 1m

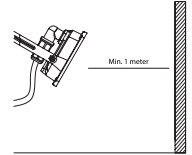

Replace any cracked protective shield.

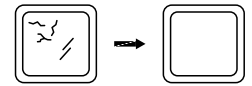

## FRAME DIMENSIONS:

LV50015 & LV50016

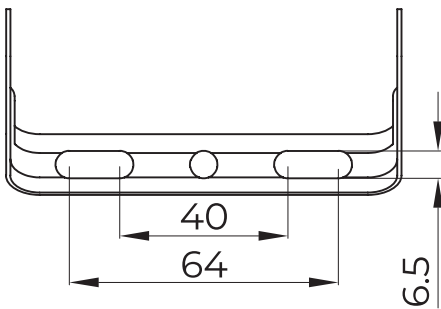

LV50017 & LV50018

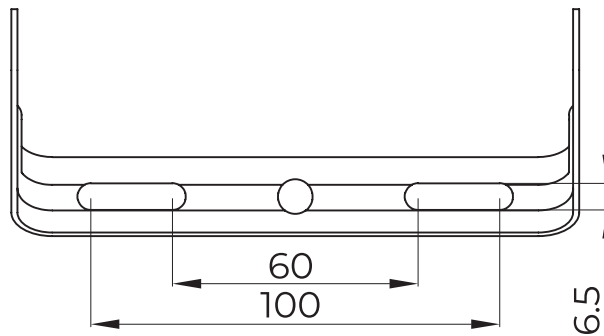

LV50019 & LV50020

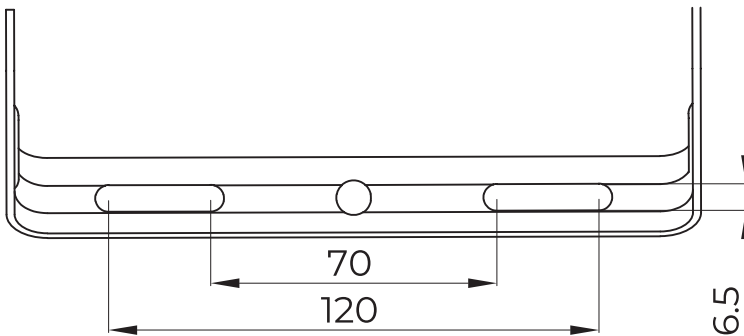

LV50021 & LV50022

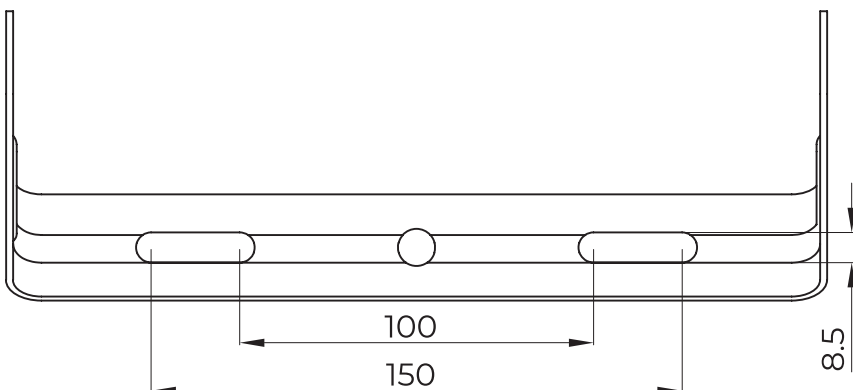

## MANUAL INSTALLATION:

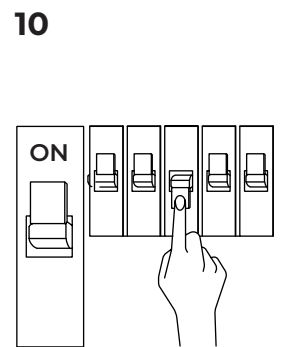
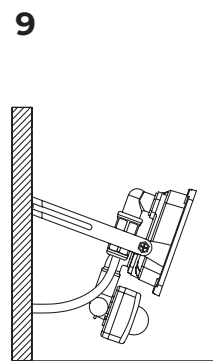
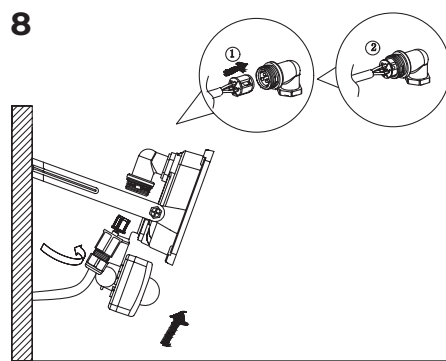
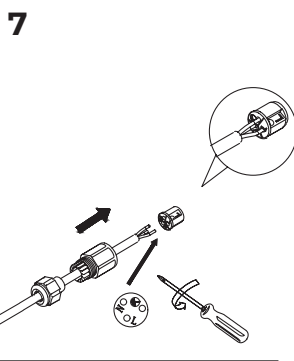
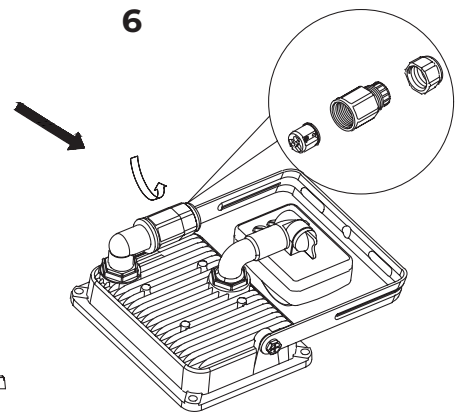
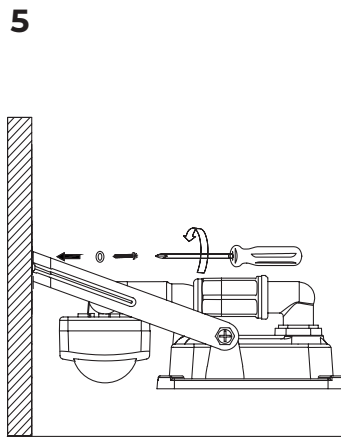
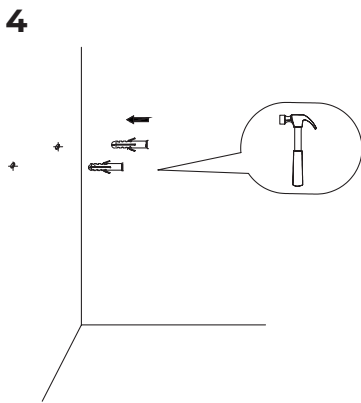
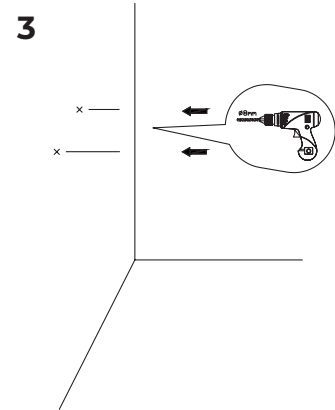
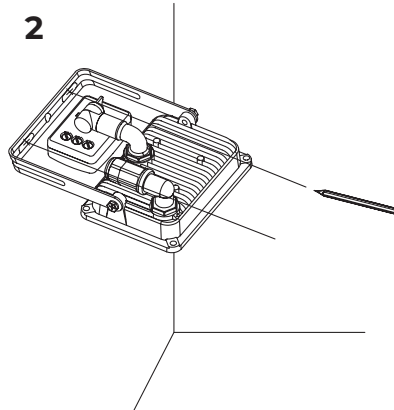
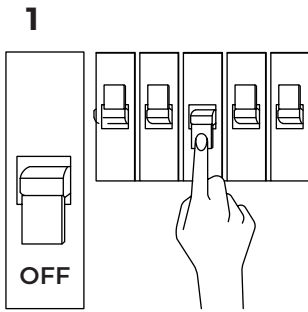

## CORRECT WAY OF USING IT:

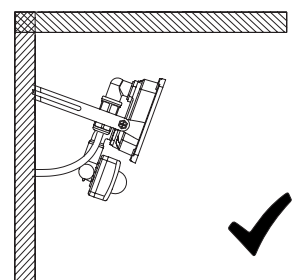
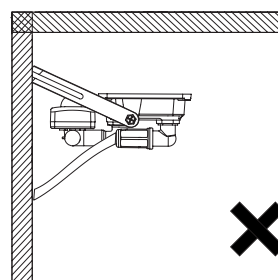
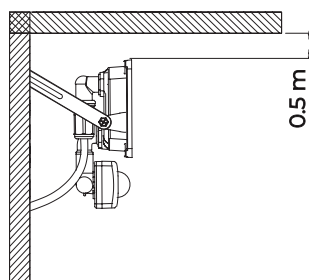
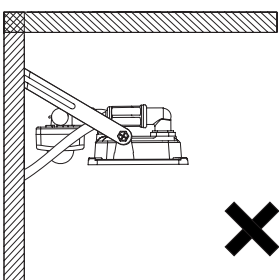

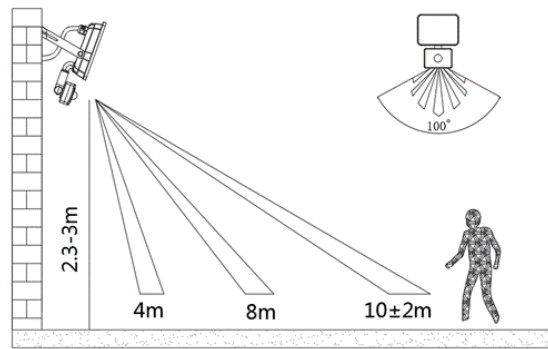

## ADJUSTING DURATION TIME & LUX CONTROL LEVEL:

### Adjusting the lux control level

The lux control module has a built-in sensing device (photocell) that detects daylight and darkness. Rotating the LUX knob clockwise is from light (☀) to dark (☾). The (☀) position denotes that the floodlights can work at day and night, and the (☾) position only works at night. You can set to operate the unit at the desired level by adjusting the LUX knob.

### Adjusting the duration time

The length of time that remains switched on after activation can be adjusted from 10±5 seconds to 10± minutes. Rotating the TIME knob from (+) to (-) will reduce the duration time.

