

Installation to a Handlebar with Bar End Weight / Cap

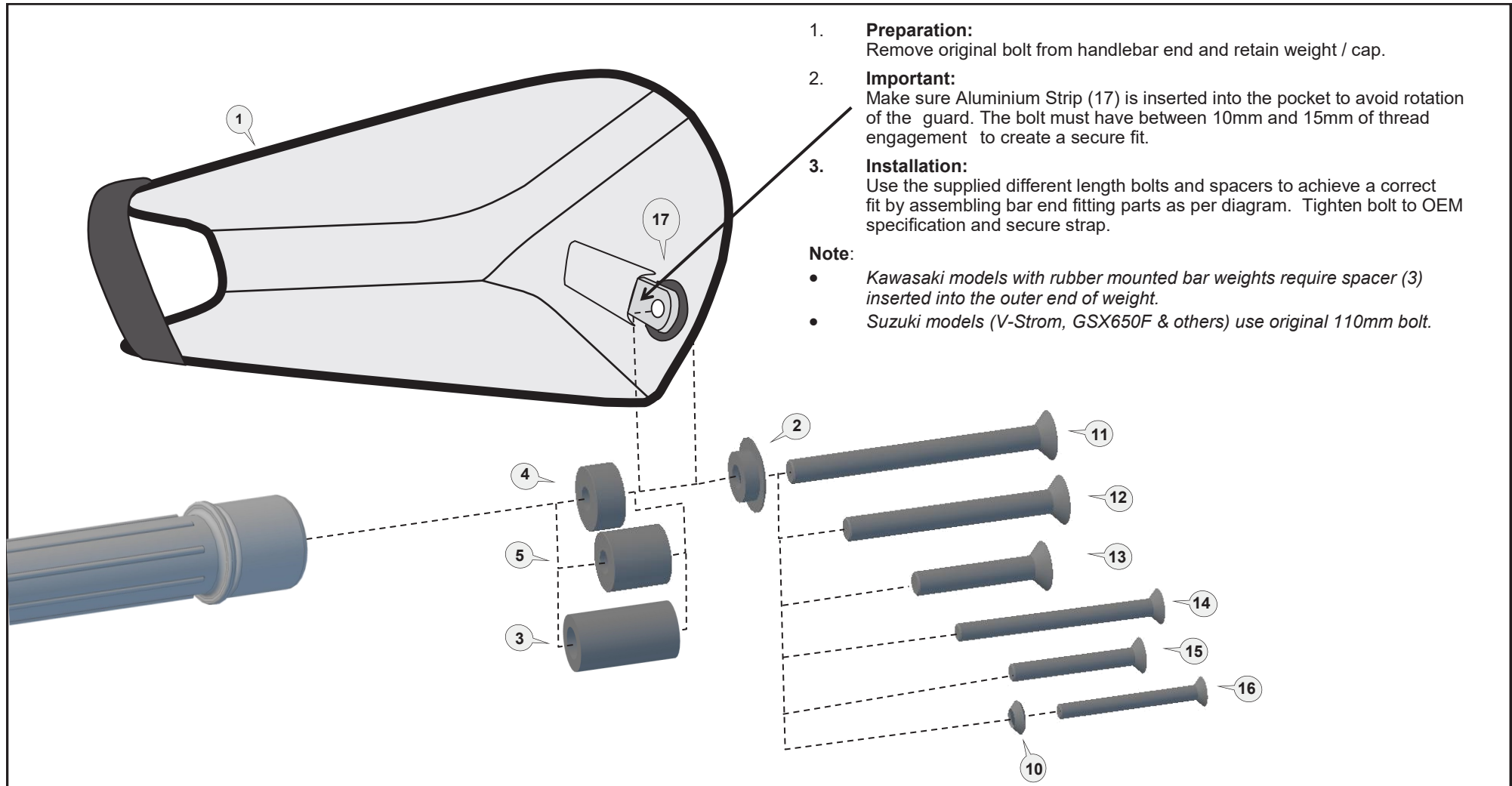

1. **Preparation:**
Remove original bolt from handlebar end and retain weight / cap.
2. **Important:**
Make sure Aluminium Strip (17) is inserted into the pocket to avoid rotation of the guard. The bolt must have between 10mm and 15mm of thread engagement to create a secure fit.
3. **Installation:**
Use the supplied different length bolts and spacers to achieve a correct fit by assembling bar end fitting parts as per diagram. Tighten bolt to OEM specification and secure strap.

Note:

- *Kawasaki models with rubber mounted bar weights require spacer (3) inserted into the outer end of weight.*
- *Suzuki models (V-Strom, GSX650F & others) use original 110mm bolt.*

Installation to a Hollow Handlebar

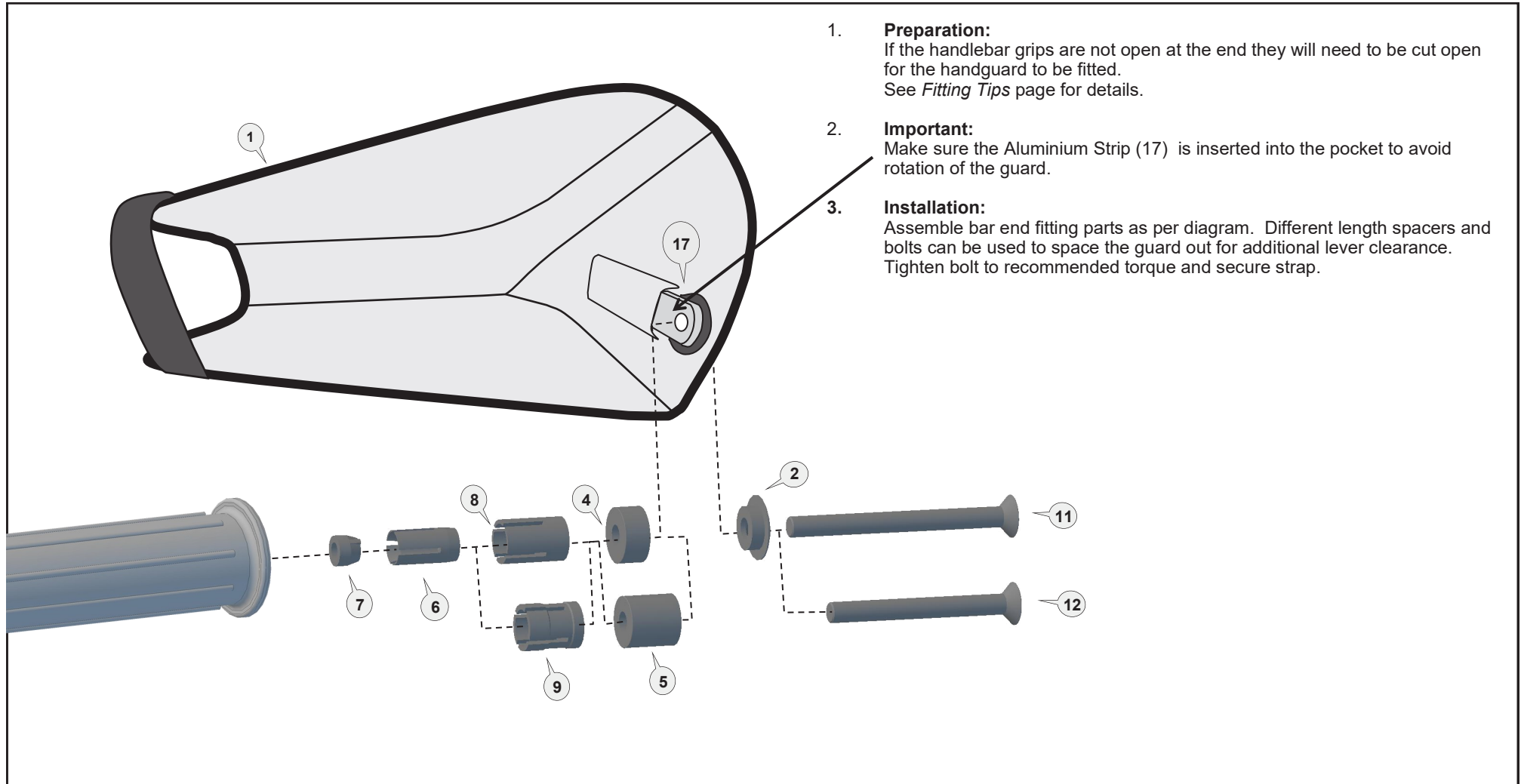



www.barkbusters.net

FITTING INSTRUCTIONS for... BBZ Fabric Guards

FITTING TIPS

- The Barkbusters BBZ fabric handguard is designed to flex around the windscreen / fairing if it makes contact when the steering is at full lock.
- **Closed Grip Preparation:**
If the handlebar grips are not open at the end they will need to be cut open for the guard to be installed. Use a sharp knife to cut a hole in the end of each handgrip. On the right side the hole size should be neat and no smaller than the inside diameter of the throttle tube. Loosen the throttle assembly to move it outward about 20mm. Roll back the end of the grip and use a hacksaw to carefully cut off the end cap of the plastic throttle tube. Do not remove more than 3mm and take care not to cut the underlying handlebar. Before refitting, remove any burrs that could restrict throttle movement.
- **Installation over Two Point Mount Aluminium Backbone** (sold separately):
Remove backbone from handlebar and remove plastic guard from backbone, if installed. Insert appropriate length bolt through collar (2), BBZ Guard (1) and outer end of backbone. Fit expander parts and insert into handlebar or attach to threaded bar end, as required: (spacers and aluminium plate not required). Re-install backbone and tighten bolts. Secure strap.
- **Honda models with rotating bar weight.**
The bar weight on many Honda models can rotate. If you experience rotation (up and down) of the handguard we recommend removal of the weight and internal handlebar parts to create a hollow handlebar. After the below removal procedure has been performed the guard can be installed using the hollow handlebar installation procedure.
Left side, roll back hand grip and depress the two retaining clips through the holes in the handlebar with a screwdriver. There is one top and one bottom. To access holes on right side, unscrew throttle housing and separate the two halves enough to slide the twist grip in from the end. Leave handlebar weight connected to the internal weight to help with removing the internal parts. Pull on weight while pressing clips through hole. See pictures below.



Left





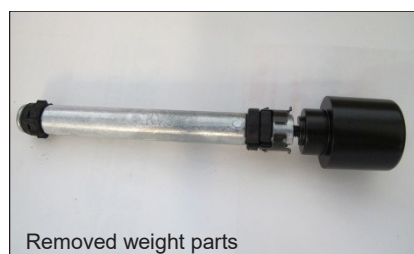







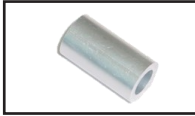

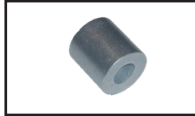

Right



Removed weight parts

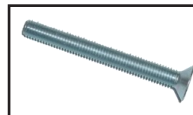

<p>1 Fabric Guard</p>  <p>PN: BZI Pcs. 1 Left & 1 Right</p>	<p>2 Collar</p>  <p>PN: COLLAR-M8FH Pcs. 2</p>	<p>3 Spacer</p>  <p>PN: SP25-14-8 Pcs. 2</p>	<p>4 Spacer</p>  <p>PN: BSSRT10 Pcs. 2</p>	<p>5 Spacer</p>  <p>PN: BSSRT20 Pcs. 2</p>	<p>6 Expander</p>  <p>PN: BBE14A Pcs. 2</p>	<p>7 Taper Nut</p>  <p>PN: NUT12 Pcs. 2</p>	<p>8 Collet</p>  <p>PN: COLLET14-16 Pcs. 2</p>
---	--	--	---	--	---	---	--

<p>9 Collet</p>  <p>PN: COLLET14-18 Pcs. 2</p>	<p>10 Cupped Washer</p>  <p>PN: M5CW Pcs. 2</p>	<p>11 Flat Head Bolt 90mm</p>  <p>PN: M8X90FHCSZP-FT Pcs. 2</p>	<p>12 Flat Head Bolt 75mm</p>  <p>PN: M8X75FHCSZP-FT Pcs. 2</p>	<p>13 Flat Head Bolt 45mm</p>  <p>PN: M8X45FHCSZP Pcs. 2</p>	<p>14 Flat Head Bolt 70mm</p>  <p>PN: M6X70FHCSZP Pcs. 2</p>	<p>15 Flat Head Bolt 45mm</p>  <p>PN: M6X45FHCSZP Pcs. 2</p>	<p>16 Flat Head Bolt 50mm</p>  <p>PN: M5X50FHCSZP Pcs. 2</p>
--	---	---	--	--	--	--	--

<p>17 Aluminium Strip</p>  <p>PN: BZ1-ALU Pcs. 2</p>
--

NOTE:

Installation of the handguard is safety-relevant work and can be complicated. We recommend the installation be performed by a motorcycle service technician.

Recommended Torque Settings	
M5	6 Nm (4.4 lbf ft)
M6	10 Nm (7.4 lbf ft)
M8	20 Nm (14.8 lbf ft)

WARNING:

Check operation of all handlebar controls, specifically the throttle, front brake, kill switch and clutch to ensure they are operating correctly and are in accordance with the OEM specifications. This check should be performed with the steering straight and also when it is at left and right full lock. If the lever end touches the guard extra spacers may be required at the handlebar end mounting point. On some motorcycles the guard may touch near the levers pivot point and hinder its function. If this occurs reposition the handguard to avoid interference. Do not ride the motorcycle with the guards installed if any controls are not operating correctly. Check periodically that all bolts are tight.

CAUTION:

Rideworx accepts no liability for damages caused by improper mounting. All bolts including all provided by Rideworx, should be tightened to the torque settings recommended by your motorcycle's manufacturer. If unavailable, use torque settings in the table provided. After the first 50km of riding check all bolts are tightened to the correct torque. We recommend a medium strength liquid thread lock product on all fasteners.

Disclaimer:

A failure to follow these fitting instructions could cause serious injury, death or property damage. These handguards are intended solely for use with motorcycles/ATV/snowmobiles/scooters that have not been modified. They are not designed to prevent injury or death while riding or in an accident or crash. The user must ensure that all controls are free of the handguards every time that they ride. By installing and/or using this product you acknowledge that you accept these terms and have followed the fitting instructions.



Email: info@barkbusters.net
Web: www.barkbusters.net

