

TUBE

Thermal Imaging Scope

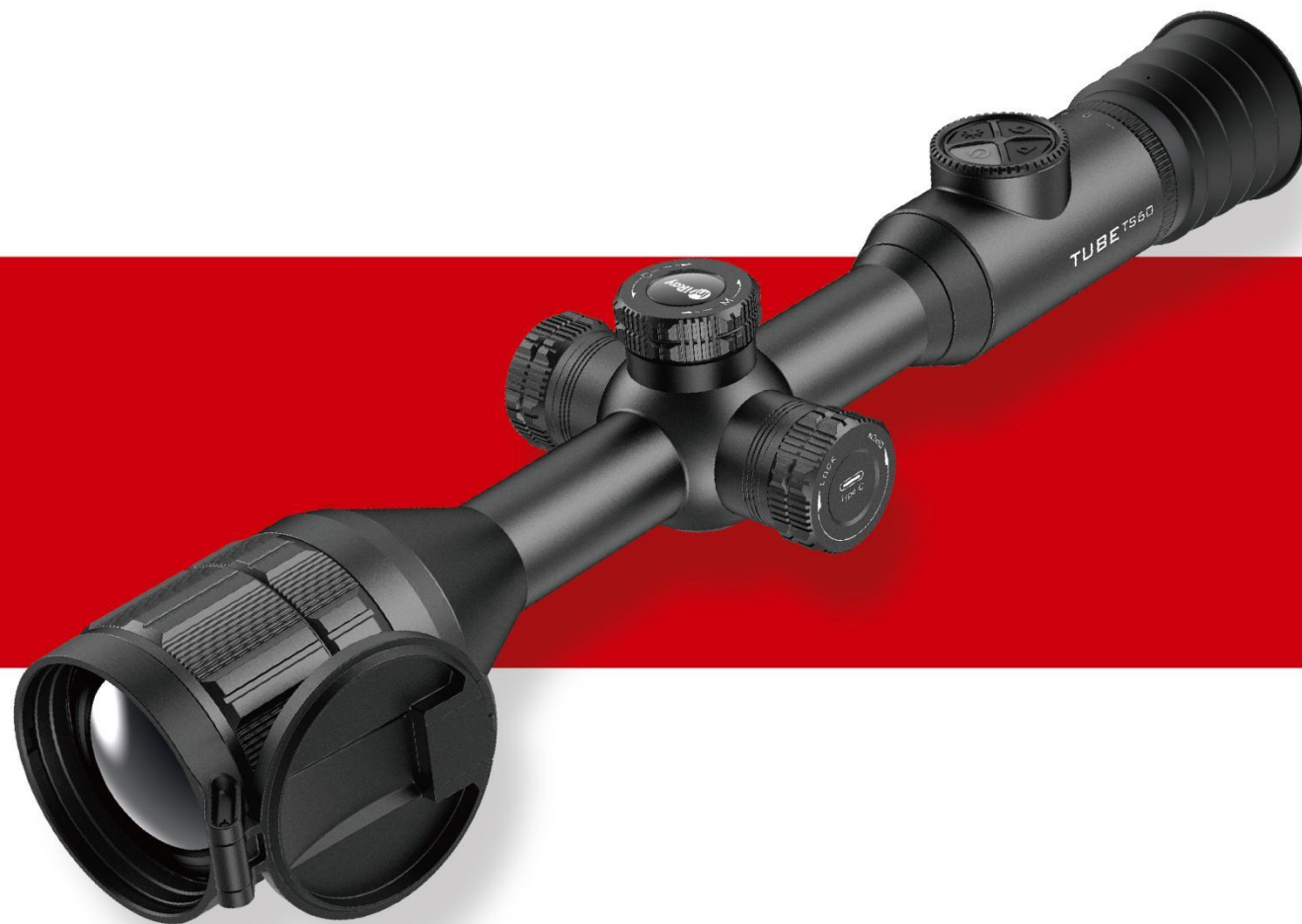

User Manual

TS60

V1.0

IMPORTANT SAFETY INFORMATION

Environmental influences

- Never point the lens of the device directly at intense heat sources such as the sun or laser equipment. The objective lens and eyepiece can function as a burning glass and damage the interior components.
- Avoid touching the metal surface (cooling fins) after exposure to sunlight or cold.

Ergonomics notes

Take breaks after longer periods of use to avoid wrist pain.

Risk of swallowing

Do not place this device in the hands of small children. Incorrect handling can cause small parts to come loose which may be swallowed.

Safety instructions for use

- Handle the device with care: rough handling can damage the internal battery.
- Do not expose the device to fire or high temperatures.
- Install the batteries correctly according to the instruction on the device. Reverse connection is prohibited.
- The battery capacity decreases when operated in a cold ambient temperature. This is not a fault and occurs for technical reasons.
- The recommended temperature for using this product is -20° to +50°. Otherwise, it will affect the service life of the product.
- Do not store the device for long periods at temperatures below -20°C or above 50°C, or it will permanently reduce the battery capacity.
- Always store the device in a dry, well-ventilated space.
- If the device has been damaged or the battery is defective, send the device to our after-sales service for repair.

Safety instructions for the power supply unit

- Check the power supply unit, cable and adapter for visible damage before use.

- Do not use any defective parts. Defective components must be replaced.
- Do not use the power supply unit in wet or humid environments.
- Only charge the device at temperatures ranging between 0°C and 50°C.
- Do not make any technical modifications.

Disposal of batteries



Directive 2006/66/EC (battery directive): This product contains a battery that cannot be disposed of as unsorted municipal waste in the European Union. For battery details, refer to the documentation of the specific product. The battery is marked with this symbol, which may include Cd (indicating cadmium), Pb (indicating lead), or Hg (indicating mercury). For proper recycling, please return the battery to your supplier or send it to a designated collection point. For more information, visit www.recyclethis.info.

User information on the disposal of electrical and electronic devices (private households)



2012/19/EU (WEEE directive): Products marked with this symbol cannot be disposed of as unsorted municipal waste in the European Union. For proper recycling, return this product to your local supplier upon the purchase of equivalent new equipment, or dispose of it at designated collection points. For more information see: www.recyclethis.info.

For business customers within the European Union

Please contact your dealer or supplier regarding the disposal of electrical and electronic devices. He will provide you with further information.

Information on disposal in other countries outside of the European Union

This symbol is only applicable in the European Union. Please contact your local authority or dealer if you wish to dispose of this product and ask for a disposal option.

Intended use

The device is intended for displaying heat signatures during nature observation, remote hunting observations and for civil use. This device is not a toy for children.

Use the device only as described in this operating manual. The manufacturer and the dealer accept no liability for damages which arise due to non-intended or incorrect use.

Function test

- Before use, please ensure that your device has no visible damage.
- Test to see if the device displays a clear, undisturbed image.
- Check that the settings for the thermal imaging monocular are correct. See the notes in the section **Power On and Image Settings**.

Installing/Removing the battery

The Tube TS60 Thermal Imaging Scope is equipped with two power supply systems - one built-in battery pack and one replaceable 18650 battery. The built-in battery pack cannot be removed.

1 Specifications

Model	TS60
Detector Specifications	
Type	Vox
Resolution, pixels	1280 × 1024
Pixel Size, μm	12
NETD, mk	≤ 18
Frame Rate, Hz	50
Optical Specifications	
Objective Lens, mm	60mm/F1.0
Field of View (H×V), °	14.7 × 11.7
Linear Field of View (H×V), m at 100m	25.6×20.5
Magnification, ×	2 ~ 16
Eye Relief, mm	50
Exit pupil Diameter, mm	6
Diopter, D	-5 ~ +3.5
Detection Range, m (Target Size: 1.7m×0.5m, P(n)=99%)	3100
Display Specifications	
Type	AMOLED 1.03"
Resolution	2560 × 2560

Battery Power Supply	
Battery	Built-in battery / 6600mAh + replaceable 18650 battery / 3200mAh
Max. Operating Time (22°C), h*	9
External Power Supply	5V (Type C)
Physical Specifications	
Wi-Fi / APP	Support (InfiRay outdoor)
Photo / Video Recorder	Support
MIC	Support
Bluetooth	Support
Recoil activated video	Support
Memory Capacity	128GB
IP rating	IP67
Operating Temperature, °C	-20~+50
Weight, g	1000
Dimension, mm	384 × 104 × 77
Connections and Compatibilities	
Max. recoil power on rifled weapon (Eo), Joules	6000
Click Value@100m, cm	2
Compatible mount	Standard 30mm rings

* The actual service time depends on the use frequency of functions like Wi-Fi, video recording, etc.

- Improvements may be made to the design and software of this product to enhance its features without prior notice.
- The newest user manual can be downloaded at our official website: www.infirayoutdoor.com.

2 Package Contents

- Tube TS60 Thermal Imaging Scope
- Eyeshade
- Picatinny rail mount
- Portable bag
- Type-C cable
- Power adapter
- Lens cloth
- 2*18650 battery
- Heated target for zeroing
- Quick start guide

3 Introduction

Tube TS60 is an infrared scope for outdoor hunting. Designed based on infrared thermal imaging principles, it requires no external light sources during the day and at night, in all hard weather conditions (such as rain, snow, fog, and haze). It can be used without being affected by strong light and to observe even targets behind obstacles (such as branches, grass, and shrubs).

Tube TS60 has a variety of battery-powered solutions with long operating hours, and can be widely used for hunting, observation and positioning in low visibility conditions.

Tube TS60 adopts a 30mm standard pipe diameter to meet the requirements of the general clamp interface.

4 Features

- 12 μ m self-developed detector
- High image quality

- Infinite zoom
- Dual power supply system, with long battery life
- Standard 30mm pipe diameter
- Expandable Laser rangefinder function
- Long detection range
- 50Hz frame rate
- Built-in memory space, supporting photographing, video recording, and simultaneous audio and video recording
- Built-in Wi-Fi module, supporting app connection
- Built-in compass and motion sensor
- PIP (picture-in-picture) function
- Pixel defect correction
- Convenient operation interface





- 4. Display brightness button
- 5. Power button
- 7. Controller
- 9. Type-C port
- 11. Battery slot cover
- 13. Lens focus ring
- 15. Microphone
- 6. Image mode button
- 8. USB cover
- 10. LED indicator
- 12. 18650 battery
- 14. Lens cap

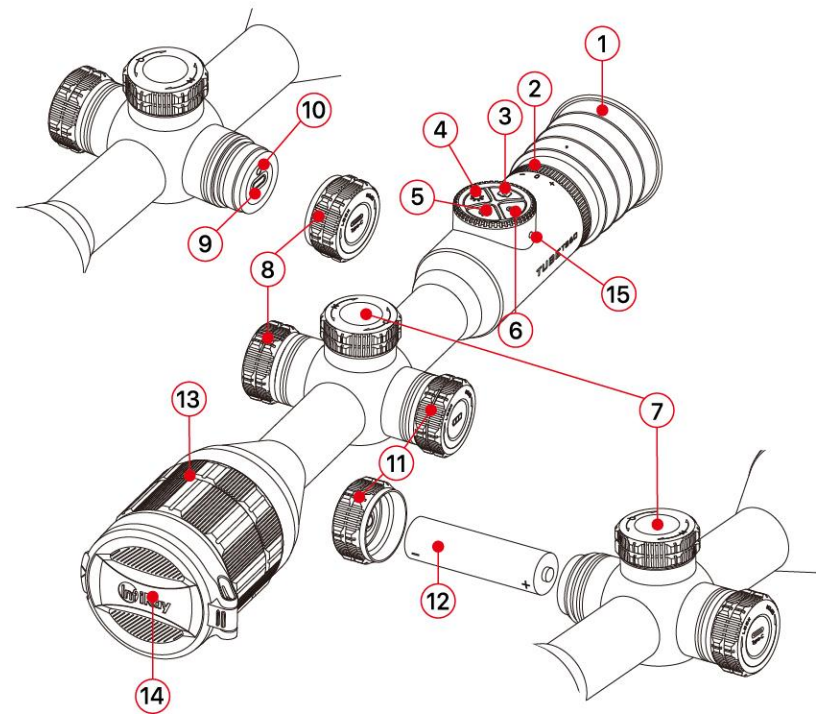

5 Components and Controls

- 1. Eyeshade
- 2. Eyepiece diopter adjustment ring
- 3. Camera button



6 Button Operation

Button	Current Status	Short Press	Long Press	Rotate
	Powered off	—	Power on the device	—
	Home screen	Image calibration	Power off / Standby the device	—
	Standby mode	Wake up the device	—	—
	Single ranging is on	Perform single ranging	—	—
	Main menu interface	Return to the upper interface without saving	—	—
	Defective pixel calibration interface	Add / Delete defective pixels	—	—
	Home screen	Switch the image mode	Turn the PIP function on/off	—
	Home screen	Adjust the display brightness	Default: turn on / off the stadiametric rangefinder function. When connected with the laser rangefinder module: turn on / off the laser indicator on the rangefinder module.	—
	Home screen	Take a photo	Start / Stop a video recording	—

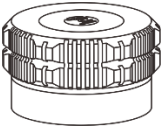
	Laser rangefinder	Switch the ranging mode between single ranging and continuous ranging	—	—
	Zeroing screen	—	Freeze the picture	—
	Home screen	—	Turn the reticle and its functions on/off	—
	Zeroing screen	—	Return reticle to the center	—
	Home screen	Enter the shortcut menu interface	Enter the main menu interface	Adjust the image magnification
	Shortcut menu interface	Adjust parameters of the function	Save and back to the home screen	Switch the menu option
	Main menu interface	Confirm selection / Enter the submenu		Move the reticle position: Clockwise - leftward / downward
	Pixel defect calibration / Zeroing interface	Switch the movement direction		Counterclockwise - rightward / upward

7 Power Supply

Tube TS60 uses a dual power supply system - a built-in rechargeable lithium-ion battery pack and a replaceable 18650 battery, with dual battery power for up to 8.5 hours of normal operating time. The battery should be fully charged before the first use.

Charging the Built-in Battery

During use, if the battery icon turns red , it indicates that the battery power is insufficient. Please charge the battery in time to avoid shortening the battery life.

- Turn counterclockwise to open the USB cover (8).
- Plug the Type-C end of the supplied USB cable (16) into the Type-C port (9) of the Tube.
- Plug the other end of the USB cable (16) into the power adapter (17) and plug the adapter into a 100-240V power socket (18) for charging.
- When charging, a lightning charging icon appears on the battery

icon, and the LED indicator (10) on the device turns red. When the indicator (10) turns green, it indicates that charging is completed.

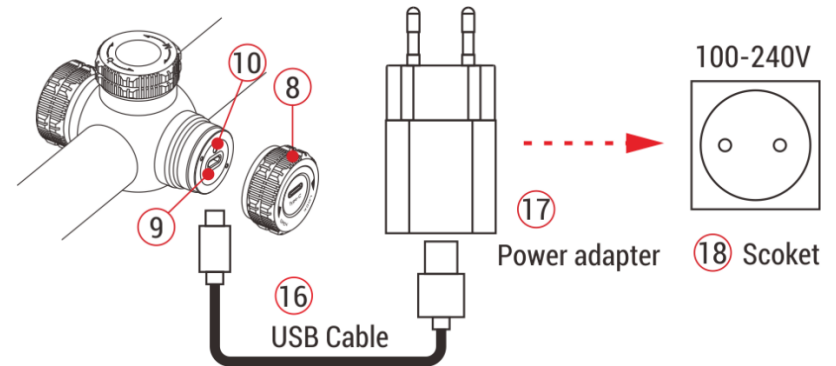

Note: It only supports charging the built-in battery pack, not the replaceable 18650 battery.

Installing the replaceable 18650 battery

- Turn counterclockwise to open the battery slot cover (11).
- Install the 18650 battery (12) according to the indication label in the battery holder, that is, the positive electrode faces inward and the negative

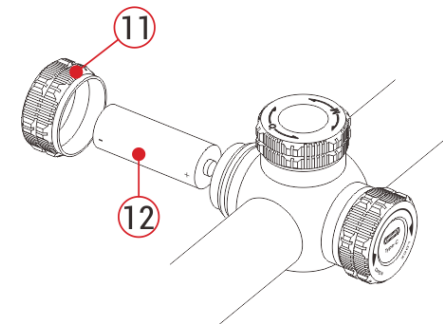

electrode faces outward.

- Close the battery slot cover **(11)** and turn clockwise to tighten it.

Safety Precautions

- When charging, please use the 5V2A power adapter compatible with the device. Using any other type of adapter may cause irreversible damage to the battery or the adapter itself.
- If the device is not used for a long time, the battery should be partially charged, not fully charged or discharged.
- Do not charge the device immediately after it is moved to a warm environment from a cold environment. Wait for 30 to 40 minutes for preheating.
- Do not use the charger if it is modified or damaged.
- The device should be charged at a temperature of 0°C to +40°C. Otherwise, the battery life will be significantly reduced.
- When charging, please do not leave the battery unattended.
- Do not connect the battery to the power supply for more than 24 hours after it is already fully charged.
- It is not recommended to connect third-party devices that consume

more energy than the allowed value.

- The device is equipped with a short circuit protection system, but conditions that may lead to a short circuit should be avoided.
- Use the device at the recommended operating temperature from -20°C to +50°C. Do not use the device beyond this temperature range, or otherwise, the use may shorten the battery life.
- When the device is used under sub-zero temperature, the battery capacity drops. This is normal and does not indicate a defect.

Switching between two types of batteries

Tube TS60 supports the dual power supply system: built-in lithium-ion battery pack and replaceable 18650 battery, while supporting a USB power supply.

- If both batteries are installed in Tube TS60, two battery icons are displayed on the two sides of the image, with the replaceable battery on the left side and the built-in battery on the right side.



Green indicates that the device is being powered, and gray indicates that the device is not powered on.

- If the replaceable battery is not installed, only a green built-in battery icon is displayed right side.
- If the replaceable battery is installed and fully charged, it will be preferred. When the replaceable battery is low, the device will switch to the built-in battery automatically.
- When the device is connected to a USB, it will switch to the external power supply automatically. At this time, a lightning-like charging icon is displayed on the built-in battery icon, which indicates that the built-in battery is being charged.
- When the device is in use, the replaceable battery can also be replaced. At this time, it will switch to the internal battery automatically, and after replacement, it will switch back to the replaceable battery automatically.

8 External Power Supply

Tube TS60 supports external power supplies, such as the portable

power source for a mobile phone (5V).

- Connect an external power supply to the USB port **(9)** of the Tube device.
- Then, the device automatically switches to the external power supply and charges the internal battery pack at the same time.
- When the external power supply is turned off, the device switches to the replaceable 18650 battery for power supply. If no replaceable 18650 battery is installed or the battery level is low, it will switch to the built-in battery pack, instead of shutdown.

9 Mounting and Usage

Mounting on the weapon

To ensure shooting accuracy, please mount the Tube at a proper position on the weapon.

- Tube TS60 needs to be fixed with an adapter clamp, such as a simple Picatinny rail clamp provided in the package. Tube TS60 adopts a tubular body design with a diameter of 30mm, which is compatible with standard clamps with a diameter of 30mm, such as

those of day scope. Proper tools can be used to install the Tube series according to the supplier's installation suggestions and steps.

- During installation, the installation position of the Tube device should be adjusted according to the distance between eye and eyepiece (eye relief) as specified in the specifications and the sense of use and comfort. If you fail to follow this suggestion, the eyepiece may hurt the shooter during the shooting.
- It is recommended to mount the scope as low as possible, but keep it away from the barrel or other devices.
- It is recommended to use a torque wrench to tighten the screws of the mounting clamp, so as to avoid damaging the scope body due to being over-tightened, and the recommended torque shall not exceed 2.5 Nm.
- When the scope is used for hunting, please carry out the zeroing operation first referring to the **Zeroing Section** in this manual.
- When using the scope at night or in a dark environment, it is recommended to use an eyeshade **(1)** to avoid being found.

Power on and Image Settings

- Remove the lens cap **(14)**.
- Press and hold the **Power button (5)** for 2s to start the device. Wait for 3s to complete the startup.
- Adjust the clarity of icons on the display by rotating the eyepiece diopter adjustment ring **(2)**.
- Rotate the lens focus ring **(13)** of the objective lens to focus on the object to be observed.
- **Set the image mode:** On the home screen, press the **Image Mode button (6)** to set the image mode, of which the options include white hot - black hot - pseudo-color - red hot - target highlighting in order.
- **Set the display brightness:** On the home screen, press the **Display Brightness button (4)** to adjust the display brightness from level 1 to 5.
- On the home screen, short or long press the **Controller (7)** to enter the shortcut menu or main menu for more functional operations.
- On the home screen, press the **Power button (5)** for image calibration. When performing background calibration, please cover

the lens cap (14). Set the calibration mode in main menu.

- After using, press the **Power button (5)** for 3s to enter the power-off interface. When the countdown icon turns from 3 to 0, the device shuts down and release the button. Then, a prompt interface **Data saving ...** is displayed. After the data is saved, the display turns black and the device is off. **When the device is powering off and saving data, do not disconnect it from its power source. Otherwise, the data cannot be saved.**
- Releasing the button during the countdown, the device will enter the standby mode. Press the **Power button (5)** again to wake up the device.

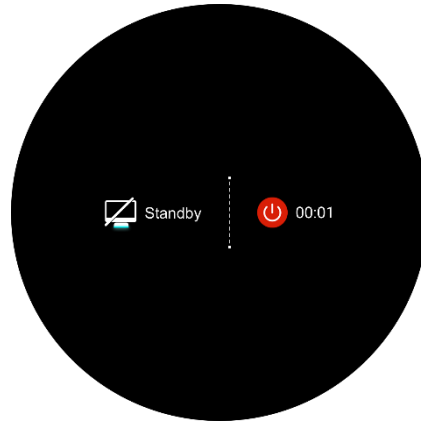

10 Status Bar



The status bar is located at the top of the image interface and displays the information related to the current operating status of the device.

Current image mode (☀ white hot; 🌑 black hot; 🔥 red hot; : pseudocolor ; 🟣 :Violet; 🟠 :Crimson; 🟢 : Viridian)

1. Current image calibration mode (A is the Auto Calibration mode; M is the Manual Calibration mode; B is the Background Calibration mode. The lens needs to be covered during background calibration)
2. Standby status and time (Off by default)

3. Clock (Set it in the main menu or synchronize the time in the InfiRay Outdoor app)
4. Ultraclear mode status: (🚫: the Ultraclear mode is off; 👁: the Ultraclear mode is on)
5. Bluetooth status (🚫: Bluetooth is off. 📶: Bluetooth is on but not successfully connected to the laser rangefinder module. 📶🔌: Bluetooth is on and successfully connected to the laser rangefinder module; 🔋: Power status of the rangefinder module)
6. Wi-Fi status (🚫: Wi-Fi OFF; 📶: Wi-Fi ON)
7. Current rifle selected and zeroing distance (Rifles to be selected: A, B, C; zeroing distance: 1~999m, customized; such as A100m)
8. Current visual magnification (TS60: 2× ~32× adjustable)
9. Power status of the replaceable battery (18650 battery)
10. Power status of the built-in battery pack.

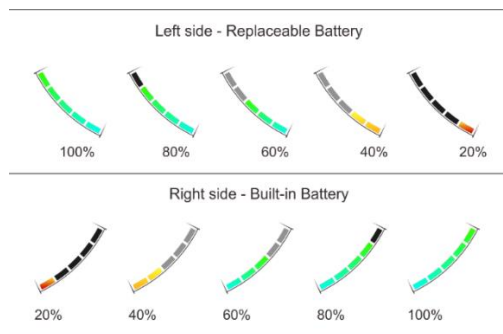

11 Zeroing

Tube TS60 uses the “freezing” zeroing method. It is better to perform zeroing in environments within the operating temperature range of Tube.

- Mount the scope on the weapon according to the instructions of **Section 9 Mounting on The Weapon.**
- When using the scope for the first time, press and hold the **Camera button (3) + Display Brightness button (4)** for more than 15s to active the hidden functions about reticle and related functions.
- Select a target at a certain distance, such as 100m, 200m.
- Adjust the scope according to the **Section 9 Powering on and Image Settings.**
- Select zeroing profile (refer to "**Main menu – Zeroing Profile**").
- Press and hold the **Controller (7)** to enter the Main Menu function.
- Rotate the **Controller (7)** to select **Reset Zeroing Distance** item (🎯). Briefly press the **Controller (7)** to enter the submenu.
- According to the preset target distance, select or add the new zeroing distance (refer to "**Main Menu - Reset Zeroing Distance**").

- After select the zeroing distance, rotate the **Controller (7)** to select the Zeroing function (—|—), and press the **Controller (7)** to enter zeroing interface. The coordinate positions of the reticle (X axis and Y axis) are displayed on the bottom of the screen.

- Aim and shoot at the target.
- Observe the position of the actual point of impact. Assume that the red mark **x** in the figure on the right is the position of the point of impact (**This mark is only for illustration. It should actually be a bullet hole**).



- If the impact point does not match the aiming point (the center of the reticle), keep the aiming position still, and then press and hold the **Palette button (6) + Photo button (3)** at the same time until a snow-



like freezing ❄ appears on the bottom of the screen, and the image is frozen.

- Rotate the **Controller (7)** to move the reticle until the reticle matches the point of impact. Rotate clockwise to move the reticle left or down, and rotate anticlockwise to move the reticle right or up.
- Press the **Controller (7)** briefly to switch the movement direction between the X and Y. The background of the selected item will be highlighted by green.
- After moving the reticle, a little white dot appears on the screen, indicating the position of the reticle before moving.
- When moving the reticle to the actual impact point, press and hold the **Controller (7)** to save the current reticle position and return to the home screen.
- Repeat aiming and shooting, until the position of the point of impact is consistent with that of the aiming point.

Note: After the zeroing position is set up, you can switch the option through **Zeroing Distance** in the shortcut menu.

12 Calibration

When the image is degraded or uneven, it can be improved by calibration. Calibration can equalize the background temperature of the detector and eliminate the image defects (such as vertical bars, phantom images, etc.).

There are three calibration modes: Auto Calibration (A), Manual Calibration (M) and Background Calibration (B).

- Select the required calibration mode in the Main Menu.
- **Auto Calibration (A):** Device will calibrate automatically according to the software algorithm. There is no need to close the lens cover (the internal shutter covers the sensor). Before automatic calibration, there will be a 5 second countdown prompt behind the shutter icon on the status bar, that can be cancelled this calibration during countdown with a short press of the **Power Button (5)**. In this mode, user can also finish the calibration manually with a short press of the **Power Button (5)**.
- **Manual Calibration (M):** On the home screen, press the **Power button (5)** briefly for manual shutter calibration without closing the

lens cover (the internal shutter covers the sensor).

- **Background Calibration (B):** On the home screen, press the **Power button (5)**, then a prompt appears on the display as “cover lens during calibration”. Cover the lens cap and background calibration will be done after 2s. After calibration, remove the lens cover.

13 Digital Zoom



The **TUBE TS60** scope supports to zoom the image from 1 time to 4 times to quickly increase the basic magnification.

- On the home screen, rotate the **Controller (7)** for a smooth zooming of the base magnification.
- Rotate clockwise to zoom in, counterclockwise to zoom out.
- The magnification is displayed at the status bar of the display in real time.
- TS60 supports the magnification from 2 times to 32 times.

14 Photographing / Video Recording

Tube TS60 is equipped with a 128GB build-in memory space, which can be used for photographing and video recording. The photo and video files will be named by time, so it is recommended to reset the system date and time in the main menu before using (refers to **Main Menu - Settings - Date/Time**), or synchronize the system date and time in the InfiRay Outdoor application.

Photographing

- On the home screen, press the **Camera button (3)** to take a photo. The image freezes for 0.5s, and the camera icon  appears on the upper left corner of the screen.
- Photos are stored in the internal memory space.
- When the exclamation mark icon  appears on the right side of



the camera icon, it prompts that the memory space is insufficient. Check and transfer your videos and images to other media to free up the space.

Video Recording

- On the home screen, press and hold the **Camera button (3)** to start a video recording.
- A recording icon and a prompt box showing the recording time appear in the upper right corner of the display, with the time format as 00:00:00 (hour: minute: second).
- During recording, you can also take photos by pressing the **Camera button (3)**.
- Press and hold the **Camera button (3)** again to stop the recording and save the video.
- All videos and photos will be saved in the built-in storage.



Note

- You can open and operate the menu during video recording.
- The images taken and the videos recorded are stored in the built-in memory space in the format of IMG_HHMMSS.jpg (image) and VID_HHMMSS.mp4 (video), with HHMMSS indicating hour/minute/second.
- The maximum duration of a video recording file is 10 minutes. When the duration is more than 10 minutes, the video will be automatically recorded onto a new file.
- The number of files is limited by the internal memory space of the device. Check the remaining space regularly, and transfer your videos and images to other media to free up the space on the memory card.
- On the recorded videos and photos, only reticle will be displayed, and the graphic data (status bar, icons and menu) are not displayed.
- We are working on something that can display GUI information on the recorded videos and photos, which can be realized by updating the program in the future.

Memory Access

When the device is powered on and connected to a computer, it will be recognized by the computer as a flash memory card. Then, you can access the memory of the device and copy images and videos.

- Connect the device to a computer through the USB cable;
- Power on the device.
- Double-click My Computer - double-click to open the device named

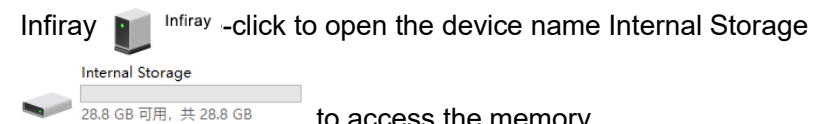

to access the memory.

- There are different folders named by time in the format of xxxx (year) xx (month) xx (day) in the memory.
- Recorded photos and videos in that day are saved in the folders
- Select desired files or folders to copy or delete.

15 PIP Function

PIP (picture-in-picture) provides a floating window independent of the full screen. This window shows part of the image which is enlarged to

2× in a certain area centered on the reticle of the main image.

- On the home screen, press and hold the **Image Mode button (6)** to turn on the PIP function.
- A separate 'window' is appeared on the top of the display simultaneously with the main image.
- When rotate the **Controller (7)** to enlarge the main image, the image shown in the PIP window will be also enlarged 2× synchronously.
- Press and hold the **Image Mode button (6)** to turn off the PIP function.

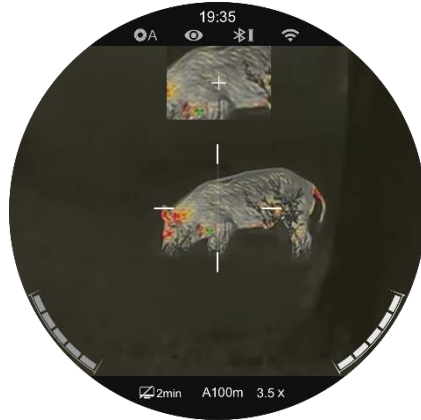

16 Rangefinder Function

Tube TS60 is equipped with a stadiametric rangefinder function, and also support external laser rangefinder module. The stadiametric rangefinder function will be temporarily disabled when connected to

the laser rangefinder module via Bluetooth.

Stadiametric Rangefinder

The stadiametric rangefinder function is to calculate the approximate distance of a target of known size.

- On the home screen, press and hold the **Display Brightness button (4)** to turn the stadiametric rangefinder function on.
- Then two horizontal lines for measurement appear symmetrically above and below the reticle, and three icons of pre-configured objects and the values of measured distance are displayed on the left side.
- Three pre-defined target values are provided as follows:
 - **Deer:** 1.7m high
 - **Wild boar:** 0.9m high
 - **Hare:** 0.2m high
- Locate the target in the middle of the measurement lines.
- Rotate the **Controller (7)** clockwise to enlarge or anticlockwise to



reduce the width of the measurement lines, so that the target is completely between the measurement lines.

- While adjusting the width of the measurement lines, the rangefinder values is automatically recalculated.
- The color and center position of the measurement line are synchronized with that of the reticle.
- To change the unit of measurement (meters or yards), please refer to **Main Menu-Settings-Units of Measure** for modification.
- Press and hold the **Display Brightness button (4)** to exit this function.

Laser rangefinder (ILR-1200-1, purchased separately)

Tube TS60 support external laser rangefinder module (ILR-1200-1) brought separately.

For detailed description of the Installation and Usage of the laser rangefinder module, please refer to the manual of the laser rangefinder in its package.

Compared with stadiametric rangefinder, the laser rangefinder is more accurate, with no need to find specific target objects.

- Press and hold the Power button on the laser rangefinder module to turn on the laser rangefinder. The LED light on the laser rangefinder module will flash.
- Long press the **Controller (7)** of Tube to enter the main menu.
- Select the **Bluetooth** option, and make sure the Bluetooth is on.
- The laser rangefinder module will automatically connect with Tube.
- When successfully connected, the LED light on the laser rangefinder module is off, and the battery icon appears on the right side of the Bluetooth icon  in the status bar, it means that the Tube is successfully connected with the laser rangefinder module.
- After the laser rangefinder module is successfully connected, press and hold the **Display Brightness button (4)** for 3s to turn on / off the **laser indicator** on the laser rangefinder module.
- There are two ranging modes for selection - continuous ranging (CON) and single ranging (SGL).
- The default ranging mode is continuous ranging mode.

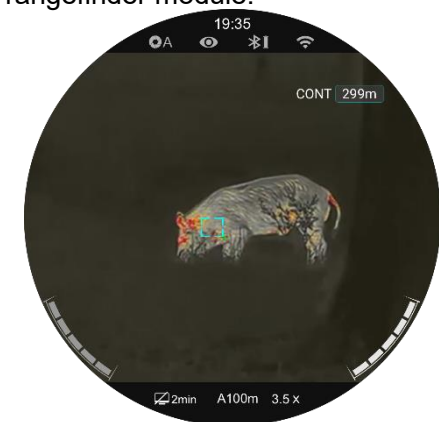

Briefly press the **Image Mode button (6) + Display Brightness button (4)** at the same time to switch the ranging mode.

- In the continuous ranging mode, the ranging is in real time and automatic without any operation.
- In the single ranging mode, briefly press the **Power button (5)** to perform the ranging operation.
- The ranging mode and ranging value are displayed in the upper right corner of the screen.
- When the ranging value shows MAX, it means that the target distance has exceeded the maximum distance (999m) of the laser rangefinder.
- Switch the measurement unit according to **Main Menu - Settings - Units of Measure**.
- During continuous ranging, other functions such as photographing and video recording are not affected.







- When the laser rangefinder module is mounted on the Tube and successfully connected with each other through Bluetooth, laser rangefinder will replace the stadiametric rangefinder.

17 Shortcut Menu

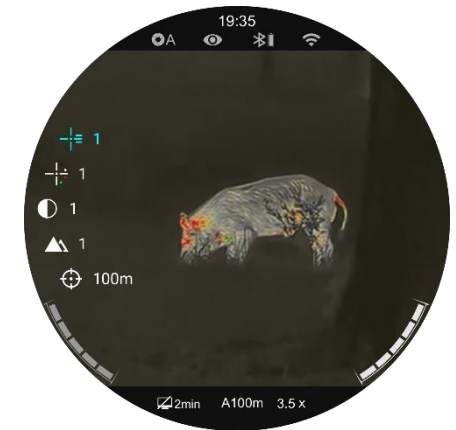
In the shortcut menu, the basic settings can be quickly reset, including reticle style, reticle color, image sharpness, and zeroing distance.

- On the home screen, press the **Controller (7)** to enter the shortcut menu interface.
- Rotate the **Controller (7)** to switch among the following function options, and the selected option is highlighted in background.
 - **Reticle Style (—|≡)**: Rotate the **Controller (7)** to select the reticle style, and press the **Controller (7)** to switch among 7 styles.



- **Reticle Color** (): Rotate the **Controller (7)** to select the option, and press the **Controller (7)** to adjust the colors in the sequence of white, black, red and green.
- **Image Contrast** (): Rotate the **Controller (7)** to select the option, and press the **Controller (7)** to adjust the image Contrast from level 1 to 5.
- **Image sharpness** (): Rotate the **Controller (7)** to select the option, and press the **Controller (7)** to adjust the image sharpness from level 1 to 5.
- **Zeroing Distance** (): Rotate the **Controller (7)** to select the option, and press the **Controller (7)** to switch the zeroing distance saved for the current rifle selected (e.g. For rifle type A, when you select the option, only the distance values saved for type A will be available).
- Press and hold the **Controller (7)** or press the **Power button (5)** to save the changes and return to the home screen.
- In the shortcut menu, if there is no operation within 5s, the device will automatically save the changes and return to the home screen.

18 Main Menu

- On the home screen, press and hold the **Controller (7)** to enter the main menu interface.
- Rotate the **Controller (7)** to switch the function options - clockwise rotation to move downward and anticlockwise to move upward.





- Press the **Controller (7)** to adjust the parameters of the current option or enter the submenu.
- The icon of the selected option will change from white to green.
- The operations for submenus are the same as above.
- In any menu interface, press and hold the **Controller (7)** to save changes and return to the home screen. Press the **Power button (5)** to return to the upper menu without saving the change.





- If there is no operation within 15s on any menu interface, it will automatically return to the home screen without saving.
- During the continuous operation, when exiting from the main menu, the selected option remains at the position before exiting (i.e., until





the riflescope is turned off). When restarting the scope and entering the main menu for the first time, the cursor stays at the first menu option (Ultraclear mode).

Main Menu Features and Descriptions

<p>Ultra-Clear Mode</p> 	<p>Turn on/off the Ultra-Clear Mode</p> <ul style="list-style-type: none"> ● Press and hold the Controller (7) to enter the main menu interface. ● Select the Ultra-Clear Mode option (selected by default on the menu after startup). ● Press the Controller (7) to turn on/off the ultra-clear mode, during which you will hear a click of shutter calibration. ● When the function is on/off, the icon in the status bar changes accordingly.
<p>Wi-Fi</p> 	<p>Turn on/off the Wi-Fi function</p> <ul style="list-style-type: none"> ● Press and hold the Controller (7) to enter the main menu interface. ● Rotate the Controller (7) to select the Wi-Fi function option. ● Press the Controller (7) to turn on/off the Wi-Fi function. ● When Wi-Fi is on, the default password is prompted for 3s behind the icon of Wi-Fi. ● The password is only displayed for the first three times. After the password is changed, it will not be displayed. ● When the function is on/off, the icon in the status bar changes accordingly.
<p>Bluetooth</p>	<p>Turn on/off Bluetooth Status</p>









	<ul style="list-style-type: none"> ● Press and hold the Controller (7) to enter the main menu interface. ● Rotate the Controller (7) to select the Bluetooth option. ● Press the Controller (7) to turn on/off the Bluetooth function. ● When the function is on/off, the icon in the status bar changes accordingly.
<p>Recoil Activated Video</p> 	<p>Turn on/off the Recoil Activated Video function</p> <ul style="list-style-type: none"> ● Press and hold the Controller (7) to enter the main menu. ● Rotate the Controller (7) to select Recoil Activated Video option. ● Press the Controller (7) briefly to turn on / off the Recoil Activated Video function. ● If the Recoil Activated Video function is on, when you shoot, TS60 will automatically record the video of 3 seconds before shooting and 2 minutes 57 seconds after shooting. ● The recording icon and prompt box showing the recording time appear in the upper right corner of the display, with the time format as 00:00:00 (hour: minute: second). <p>The video will be saved in the built-in storage. If there is a continuous shooting within 3 minutes, only one video will be saved.</p> 



<p>Motion Sensor</p> 	<p>Turn on/off the motion sensor and Compass function</p> <ul style="list-style-type: none"> ● Press and hold the Controller (7) to enter the main menu interface. ● Rotate the Controller (7) to select Motion Sensor option. ● Press the Controller (7) to turn on/off the motion sensor and compass function. ● When the motion sensor is on, two scales are displayed on right side of the display. ● The horizontal scale represents the tilt angle and the vertical scale represents the pitch angle. 	
<p>Ballistic calculation</p> 	<p>Turn on/off the Ballistic calculation function</p> <p>Note: To use Ballistic calculation function, the ILR-1200-1 is required</p> <ul style="list-style-type: none"> ● Press and hold the Controller (7) to enter the main menu interface. ● Rotate the Controller (7) to select Ballistic calculation option. ● Press the Controller (7) to turn on/off the Ballistic calculation function. ● There are 5 groups of ballistic models from Profile 0-4 to choose from Profile option ● You can set ballistic parameters by InfiRay Outdoor APP or TUBE device itself ● After the setting is complete, the system will automatically display the proposed cross-hair location when a single ranging is performed 	
<p>Laser Calibration</p> 	<p>When the target position pointed by the laser indicator is not aligned with the center of the rangefinder cursor on the screen, it needs to calibrate the position of laser rangefinder cursor by this function (the laser rangefinder module is required).</p> <ul style="list-style-type: none"> ● Install the laser rangefinder module on Tube. 	



- Turn on the Bluetooth function in the main menu to connect the laser rangefinder module with Tube via Bluetooth.
- Press and hold the **Brightness button (4)** to turn on the laser indicator on the laser rangefinder module.
- Press and hold the **Controller (7)** to enter the main menu interface.
- Rotate the **Controller (7)** to select **Laser Calibration** option.
- Press the **Controller (7)** to enter the Laser Calibration interface.
- The reticle appears on the screen, and the prompt information as below shown in the upper left corner:
 - X is the X-axis (horizontal)
 - Y is the Y-axis (vertical)
 - Center means to return the cursor to the center of the screen.
- Assume that the red "x" in the figure represents the target position aimed by the laser indicator (it is actually displayed as a red dot).
- Press the **Controller (7)** briefly to select X, Y or Center.
- When select X or Y, rotate the **Controller (7)** to move the laser cursor until the center of the laser cursor is aligned with the red "x" (the position that the laser indicator aims at). Rotate clockwise to move leftward / downward, and rotate counterclockwise to move rightward / upward.
- When Center is selected, short press the **Power button (5)** to center the laser cursor on the screen.
- When X or Y is selected, short press the **Power button (5)** to exit the laser calibration without saving.
- After calibration, press and hold the **Controller (7)** to save and exit to the home screen.



<p>Zeroing Profile</p> 	<p>Selecting zeroing</p> <ul style="list-style-type: none"> ● Press and hold the Controller (7) to enter the main menu interface. ● Rotate the Controller (7) to select Zeroing Profile option. ● Press the Controller (7) to open the secondary menu of Zeroing Profile. ● Rotate the Controller (7) to select one from the three rifles (A, B, C). ● Press the Controller (7) to confirm the selection, and return to the main menu. ● The name of the selected profile appears in the status bar at the bottom of the display. 	
<p>Reset Zeroing Distance</p> 	<p>Please select a zeroing profile and set the zeroing distance before carrying out any zeroing operation.</p> <p>TUBE TS60 supports any zeroing distance in the range of 1 to 999 meters.</p> <ul style="list-style-type: none"> ● Press and hold the Controller (7) to enter the main menu interface. ● Rotate the Controller (7) to select Reset Zeroing Distance option. ● Press the Controller (7) to enter the secondary menu of Reset Zeroing Distance, where displays the zeroing distances. ● Rotate the Controller (7) to select one zeroing distance based on the preset target distance. ● Press the Controller (7) to confirm the zeroing distance, and enter the zeroing distance submenu, including two options as below, that is Zeroing and Reset Zeroing Distance. 	
<p>Zeroing</p> 	<p>If the preset zeroing distance is consistent with that displayed on the device, you can perform zeroing directly as below:</p> <ul style="list-style-type: none"> ● Rotate the Controller (7) to select Zeroing option. ● Press the Controller (7) to enter the zeroing interface. 	

		<ul style="list-style-type: none"> ● The X and Y coordinates of the reticle are displayed on the bottom of the screen. ● Aim the reticle center of the scope at the bull's eye at the target distance and shoot, and then observe the position of the actual point of impact. ● Keep the aiming position still, and meanwhile press and hold the Image mode button (6) + Camera button (3) at the same time until a freezing icon appears below the Y coordinate on the left of the screen. The image is frozen. ● Rotate the Controller (7) to move the reticle position, until the reticle center aims at the position of the point of impact. For details, refer to Section 11 Zeroing. 	
<p>Reset Zeroing</p> <p>Distance</p> <p>▼ 000 ▲</p>		<p>If the zeroing distance is not consistent with the preset target distance, this option can be used for reset a distance.</p> <ul style="list-style-type: none"> ● Select an invalid zeroing distance, briefly press the Controller (7) to enter its submenu. ● Rotate the Controller (7) to select Reset Zeroing Distance. ● Press the Controller (7) to activate the zeroing distance reset function, and then two small triangle symbols are displayed above and below the number. ● Rotate the Controller (7) to set the number value of the current position, which can be switched 	





		<p>between 0 to 9.</p> <ul style="list-style-type: none"> ● Press the Controller (7) to switch among the positions of hundred, ten and one digits. ● After setting, press and hold the Controller (7) to save the setting and exit. Meanwhile the zeroing distance changes accordingly. ● Besides, the status bar updates to the new zeroing distance synchronously.
<p>Calibration</p> 	<p>Select calibration mode</p> <p>There are three calibration modes: Auto Calibration (A), Manual Calibration (M), and Background Calibration (B).</p> <ul style="list-style-type: none"> ● Press and hold the Controller (7) to enter the main menu interface. ● Rotate the Controller (7) to select Calibration option. ● Press the Controller (7) to open the secondary menu of Calibration. ● Rotate the Controller (7) to select one from the following: <ul style="list-style-type: none"> - Auto Calibration: It is defined by software algorithms, and images are calibrated automatically in this mode. - Manual Calibration: Images are calibrated by the user according to the image effect. - Background Calibration: The camera must be covered with a lens cap in this mode. ● Press the Controller (7) to confirm the selection. The icon in the status bar changes accordingly. 	
<p>Standby Settings</p> 	<p>Set standby status and time</p> <ul style="list-style-type: none"> ● Press and hold the Controller (7) to enter the main menu interface. 	



	<ul style="list-style-type: none"> ● Rotate the Controller (7) to select Standby Settings option. ● Press the Controller (7) to enter the submenu of Standby Settings, including four options, respectively 2min, 4min, 6min and off. ● Rotate the Controller (7) for selection, and press the Controller (7) to confirm the selection. ● The selected option is displayed in the top status bar. ● If Off is selected, the standby function is disabled. <p>Note:</p> <ul style="list-style-type: none"> - The standby mode is activated automatically when the device is tilted up or down at an angle of more than 70° and left or right at an angle of more than 30°. - When the device is in the shooting status, the standby mode is disabled. 	
<p>Pixel Defect Correction</p> 	<p>When using the scope, you may see pixel defects, such as visible light spots or dark spots with stable brightness. To address this problem, use the Pixel Defect Correction function to remove the pixel defects.</p> <ul style="list-style-type: none"> ● Press and hold the Controller (7) to enter the main menu interface. ● Rotate the Controller (7) to select Pixel Defect Correction option. ● Press the Controller (7) to enter the Pixel Defect Correction interface. ● The PIP function is automatically turned on, and displayed on the bottom of the screen by default. The moving directions (X-axis and Y-axis) and the numbers of corrected 	





pixels are shown on the top of the screen.





- In the pixel defect correction interface, the reticle is instead by a small cross cursor.
- Rotate the **Controller (7)** to move along the direction selected, rotate it clockwise to move leftward or downward, and rotate anticlockwise to move rightward or upward.
- Press the **Controller (7)** to save moving data and switch the movement direction between the X axis and the Y axis.
- When the cursor moves to the position of the defect pixel, press the **Power button (7)** to add and correct it. At the same time, the word **Add** flashes on the PIP window indicating that the pixel defect has been added.
- At the same position, press the **Power button (7)** again to revoke the defect pixel correction and the word **Del** will flash on the PIP window.
- Repeat the above steps to complete the correction of other defect pixels.
- Each time you add or delete a defect pixel, the number of defect pixels changes accordingly.
- When the cursor moves near the PIP window, PIP window moves to the top automatically.
- After correction, press and hold **Controller (7)** until a prompt "**Do you want to keep these settings?**" is displayed.
- Rotate the **Controller (7)** to select '**Yes**' to save and exit, or select '**No**' to cancel saving and exit.
- Press the **Controller (7)** briefly to confirm the selection.
- When **Yes** is selected, a **5-second Saving** countdown appears on the screen. It will exit



	<p>to the home screen after the prompt Saving successful appears.</p>	
<p>Compass Calibration</p> 	<p>Calibrate the digital compass</p> <ul style="list-style-type: none"> ● Press and hold the Controller (7) to enter the main menu interface. ● Rotate the Controller (7) to select Compass Calibration option. ● Press the Controller (7) to enter the Compass Calibration interface. ● An icon like a triaxial coordinate system appears on the screen. ● In the 15 seconds, rotate the scope along the three axes indicated by the icon, with each axis rotating at least 360°. ● After 15s, the calibration is finished automatically and exit to the home screen. 	
<p>Settings</p> 	<p>This function is used to set the date, time, language, measurement unit, status auto hiding, factory reset, and view the device information.</p> <ul style="list-style-type: none"> ● Press and hold the Controller (7) to enter the main menu interface. ● Rotate the Controller (7) to select the Settings option. ● Press the Controller (7) briefly to enter the submenu. ● This menu item allows you to configure the following settings. 	
	<p>Date</p> 	<p>Set system date</p>

		<ul style="list-style-type: none"> ● Rotate the Controller (7) to select Date option. ● The date is displayed in yy/mm/dd format. ● Press the Controller (7) to activate the date reset function. ● Two small triangle symbols are displayed above and below the number of 'Year' in default. ● Press the Controller (7) to switch year, month and date. ● Rotate the Controller (7) to set the correct number. ● After setting, press and hold the Controller (7) to save and exit the date reset function. 	
<p>Time</p> 	<p>Set system time</p>	<ul style="list-style-type: none"> ● Rotate the Controller (7) to select Time option. ● The time is displayed in 24-hours format as hour: minute. ● Press the Controller (7) to activate the time reset function. ● Two small triangle symbols are displayed above and below the number of 'Hour' in default. ● Rotate the Controller (7) to set the correct number. ● Press the Controller (7) to switch between the hour and minute. ● After setting, press and hold the Controller (7) to save changes and exit the time reset function. ● After resetting, the time displayed in the status bar will be updated accordingly. 	

<p style="text-align: center;">Language</p> 	<p>Set the system language</p> <ul style="list-style-type: none"> ● Rotate the Controller (7) to select Language option. ● Press the Controller (7) to enter the Language submenu. ● Rotate the Controller (7) to switch different languages. ● Press the Controller (7) to confirm the selection, and the system language will change automatically. 	
<p style="text-align: center;">Units of Measure</p> 	<p>Set the unit of measure</p> <ul style="list-style-type: none"> ● Rotate the Controller (7) to select Units of Measure option. ● Press the Controller (7) to enter the submenu of the Units of Measure. ● Rotate the Controller (7) to switch between meter and yard. ● Press the Controller (7) to confirm the selection, and exit to the upper menu interface. 	

<p style="text-align: center;">Status Bar Auto Hiding</p> 	<p>Turn on/off the Status Bar Auto Hiding function</p> <ul style="list-style-type: none"> ● Rotate the Controller (7) to select Status Bar Auto Hiding option. ● Press the Controller (7) to open the submenu of the Status Bar Auto Hiding. ● Rotate the Controller (7) to select Show or Hide. ● Press the Controller (7) to confirm the selection, and return to the upper menu interface. 	
<p style="text-align: center;">Image Hue</p> 	<p>Setting the image hue</p> <ul style="list-style-type: none"> ● Rotate the rotary Controller (7) to select the Image Hue option. ● Press the rotary Controller (7) to enter the submenu of the image hue. ● Rotate the rotary Controller (7) to switch between Warm and Cold. ● Press the rotary Controller (7) to confirm your selection and exit to the upper menu interface. 	
<p style="text-align: center;">Factory Reset</p>	<p>Reset to the factory settings</p> <ul style="list-style-type: none"> ● Rotate the Controller (7) to select Factory Reset option. 	





- Press the **Controller (7)** to open the submenu of the **Factory Reset**.
- Rotate the **Controller (7)** to select **Yes** for restoring factory settings or **No** for canceling the operation.
- Press the **Controller (7)** to confirm the selection.
- If **Yes** is selected, the scope will restart automatically.
- If **No** is selected, it will be back to the upper menu automatically.

The following functions will be restored to their default settings:

- | | | |
|---------------------------------|--------------------------------------|----------------------------------|
| - Image Mode: White hot | - Shutter Calibration Mode: A | - Motion Sensor: Off |
| - Zeroing Distance: A100 | - Compass: Off | - Language: English |
| - Ultra-Clear Mode: Off | - Standby Mode: Off | - Units of Measure: Meter |
| - Magnification: 2× | - Wi-Fi: Off | - Status Auto Hiding: Off |



	<p style="text-align: center;">Info</p> 	<p>View the device information</p> <ul style="list-style-type: none"> ● Rotate the Controller (7) to select Info option. ● Press the Controller (7) to view the system information about the scope, including the product model, GUI version, SYS Info, Boot version, FPGA, PN and SN number of the riflescope, Hardware version. ● Press and hold the Controller (7) to exit and return to the upper menu. 	
--	--	---	---

19 Status Auto Hiding

This function is used to hide the GUI automatically and display the reticle only so that there is no blocking on the image.

- Press and hold the **Controller (7)** to enter the main menu on the home screen.
- Rotate the **Controller (7)** to select **Settings** option.
- Press the **Controller (7)** to enter the submenu of **Settings**, and Rotate the **Controller (7)** to select **Status Auto Hiding** option.
- Press the **Controller (7)** to enter the submenu of **Status Auto Hiding** and then select **On** option.
- Press the **Controller (7)** to turn on the **Status Auto Hiding** function.
- After the Status Auto Hiding is on, all GUI icons including the status bar are automatically hidden and only the image and reticle are displayed if there is no operation within 8s.
- The GUI will be displayed again with the press of any button.
- Only after the GUI is displayed, the buttons and menus can be manipulated.

20 Wi-Fi

Tube TS60 has a built-in Wi-Fi module and can connect wirelessly to a mobile device (laptop or mobile phone) via Wi-Fi.

- On the main menu, turn on the Wi-Fi function (refer to **Main Menu - Wi-Fi** for details).
- After the Wi-Fi function is on, search for the Wi-Fi signal with the name "TUBE_XXXXXX" on the mobile device, XXXXXX is a 6-bit code of the serial number composed of digits and letters.
- Select the Wi-Fi and enter the password to connect. The initial password is 12345678.
- When Wi-Fi is successfully connected, it supports to control the scope via the **InfiRay Outdoor** App downloaded in the mobile device.

Setting Wi-Fi Name and Password

The name and password of the Wi-Fi in Tube series can reset on the **InfiRay Outdoor** App.

- After the scope is connected to the mobile device, locate and click

the **'Settings'** icon  on the **InfiRay Outdoor** image screen to enter the **Settings** interface.

- In the text box, enter and submit the new Wi-Fi name (SSID) and password.
- It needs to reboot the device to take the new name and password effect.

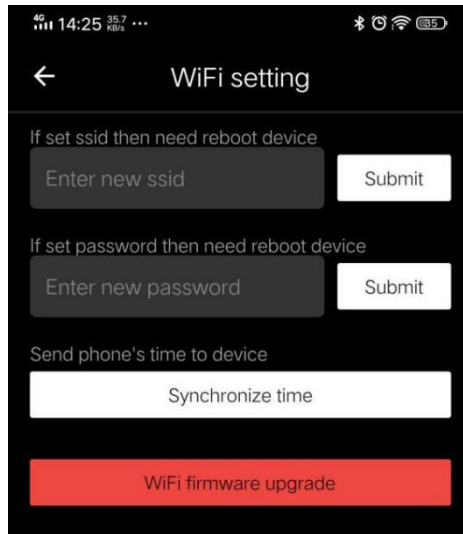

Note: If the device is reset to the factory settings, the name and password of the Wi-Fi will also be restored to the default settings.

21 Updates and InfiRay Outdoor

The Tube TS60 Thermal Imaging Scope support **InfiRay Outdoor** technology, which allows you to transmit images to the smartphone or tablet via Wi-Fi in real time mode.

The user manual of InfiRay Outdoor can be downloaded at our official website (www.infirayoutdoor.com).

Continuous improvements will be made to improve the user experience. The latest programs can be automatically detected and updated via the InfiRay Outdoor App. Also, it is feasible to download and update from the official website: www.infirayoutdoor.com.

About InfiRay Outdoor

- You can download and install the InfiRay Outdoor App on the official website (www.infirayoutdoor.com) or the app store. Alternatively, you can scan the QR code below to download it for free.



- Open the InfiRay Outdoor App after installation.
- If your device has been connected to a mobile device, please turn on the mobile data of the mobile device. After connection, an update prompt will be displayed automatically on the App. Tap **Now** to download the latest version immediately or **Later** to update later.

- InfiRay Outdoor automatically registers the last connected device. Therefore, once you have connected with InfiRay Outdoor before, it will automatically detect the update even when the scope is not connected to the mobile device.
- If an update is available and the mobile device accesses the Internet, you can download the update first. Then when the device is connected with the mobile device, it will be updated automatically.
- After the update is installed, the device will restart automatically.

22 Technical Inspection

Perform a technical inspection to check the following items each time before you use the device.

- Exterior of the device (no crack on the enclosure);
- Lens and eyepiece (no crack, oil, stain, or other sediments);
- Status of the rechargeable battery (fully charged in advance) and electrical contact (no salinization or oxidation).

23 Maintenance

The maintenance should be carried out at least twice a year and includes the following steps:

- Wipe the surface of metal and plastic parts to clear off dust and dirt by using a cotton cloth. Silicone grease may be used for the cleaning process.
- Clean the electric contacts and battery slots on the device using a non-greasy organic solvent.
- Check the glass surface of the eyepiece and lens. If necessary, clear off the dust and sand on the lens (it is perfect to use a non-contact method). Use a specialized wiping tool and solvent to clean the optical surfaces.

24 Troubleshooting

The following table lists all problems that are likely to occur during device operation. Check and address problems by referring to this table. If faults not included in this table occur or you cannot fix the

fault, return the device to its vendor or supplier for troubleshooting.

Fault	Possible Causes	Solution
The scope cannot be started.	The battery is out of charge.	Charge the battery.
The device cannot be powered by using an external power supply.	The USB cable is damaged.	Replace the USB cable.
	The external power supply is insufficient.	If necessary, check the external power supply.
Images are unclear, vertical lines are present, or the background is not even.	Calibration is required.	Calibrate the images as instructed in this User Manual.
The image is too dark.	The screen is not bright enough.	Adjust the display brightness.
The icons are clear but the image is blurry.	The lens is not focused.	Rotate the lens focus ring to adjust the focus.
	The inner or outer optical surface of the lens is dusted or iced.	Wipe the outer optical surface by using a soft cotton cloth or leave the scope to dry in a warm and dry environment for more than 4 hours.
The position of the reticle moves after shooting.	The scope or the clamp is not mounted firmly.	<p>Check whether the scope is mounted firmly.</p> <p>Ensure that the bullet type and caliber you use are consistent with that used for zeroing.</p> <p>If you perform zeroing in summer but use the scope in winter (or vice versa), the zeroing point may move slightly.</p>
The scope cannot focus.	Wrong settings.	Set the scope according to the contents of Section Power-on and Settings in this user manual.

		<p>Check the outer surface of the objective lens and eyepiece, and if necessary, wipe off any dust and frost on it.</p> <p>In cold weather, a special antifogging coating can be applied (such as those used on eyeglasses or car rearview mirrors).</p>
The device cannot connect to the mobile device.	The Wi-Fi password is incorrect.	Enter the correct password.
	Too many Wi-Fi networks around the device.	Move the device to an area with no or fewer Wi-Fi signals.
Wi-Fi signals are lost or interrupted.	<p>The device is beyond Wi-Fi coverage.</p> <p>There is blocking (such as concrete walls) between the device and the receiver.</p>	Move the device to a place where you can receive Wi-Fi signals.
The observed target disappears.	Observation through glass.	Observe the target directly without the presence of glass.
The image quality is poor or the detection range is shortened.	These problems are likely to occur when you use the device in harsh weather (such as snow, rain, and fog).	
When the device is used at a low temperature, the imaging quality is poorer than that at a normal temperature.	<p>At temperatures above 0°C, the temperature rise varies with the observed objects (environment and background) due to different heat conductivity coefficients. As a result, high-temperature contrast occurs and the image quality is better.</p> <p>At low temperatures, the observed targets (background) usually cool down to a similar temperature because of reduced temperature contrast. Therefore, the image quality (details) is poor, which is a</p>	

characteristic of thermal imaging devices.

25 Legal and Regulatory Information

Wireless transmitter module frequency range:

WLAN: 2.412-2.472 GHz

Wireless transmitter module power < 20 dBm

 We hereby declares that the radio equipment types TS60 is in compliance with the Directives 2014/53/EU and 2011/65/EU

FCC Statement

FCC ID: 2AYGT-2D-00

Labeling requirements

This device complies with part 15 of the FCC Rules. Operation is subject to the following two conditions: (1) This device may not cause harmful interference, and (2) this device must accept any interference

received, including interference that may cause undesired operation.

Information to the user

Any Changes or modifications not expressly approved by the party responsible for compliance could void the user's authority to operate the equipment.

EMC: Class A

Note: This equipment has been tested and found to comply with the limits for a Class A digital device, pursuant to part 15 of the FCC Rules. These limits are designed to provide reasonable protection against harmful interference when the equipment is operated in a commercial environment. This equipment generates, uses, and can radiate radio frequency energy and, if not installed and used in accordance with the instruction manual, may cause harmful interference to radio communications. Operation of this equipment in a residential area is likely to cause harmful interference in which case the user will be required to correct the interference at his own

expense.

To comply with RF exposure requirements, a minimum separation distance of 0.00 cm must be maintained between the user's body and the handset, including the antenna.