

MAZDA

GB	ENTRY PROTECTION FOIL Installation Instruction
D	EINSTIEGSLEISTENSCHUTZFOLIE Einbauanleitung
E	SIDE PELÍCULA DE PROTECCIÓN ALFÉIZAR Instrucciones de montaje
F	CÔTÉ FILM DE PROTECTION DE SEUIL Instructions de montage
I	SIDE PELLICOLA DI PROTEZIONE DAVANZALE Istruzioni di montaggio
P	PELÍCULA DE PROTEÇÃO SOLEIRA SIDE Instruções de montagem
NL	DORPELVERBREDERS BESCHERMFOLIE Inbouw-instructie
DK	VENTILATIONSGITTER BESKYTTELSE FILM Monteringsvejledning

N	VRIDERE FILM Monteringsveiledning
S	SIDO SILL SKYDDSFILM Monteringsanvisning
SF	SIVUHELMAVERHOUKSET SUOJAKALVO Asennusohje
CZ	BOČNÍ PRÁH OCHRANNÁ FÓLIE Návod k montáži
H	OLDALSÓ PÁRKÁNY FILM Beszerelési utasítás
PL	FOLIA OCHRONNA BOCZNA PARAPET Instrukcja zabudowy
GR	ΠΛΕΥΡΑ ΤΗΣ ΜΕΜΒΡΑΝΗΣ ΠΕΡΒΑΖΙ ΠΡΟΣΤΑΣΙΑ Οδηγίες τοποθέτησης
RUS	СТОРОНА ФИЛЬМ ПОДОКОННИК ЗАЩИТА инструкция по установке

CX-5 KE/GH

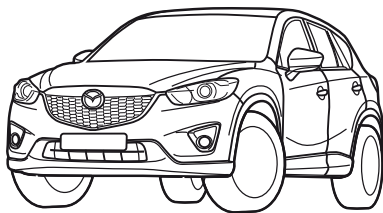

MAZDA 6 GJ

MAZDA 6 GH

JMZGJ *****120400 →

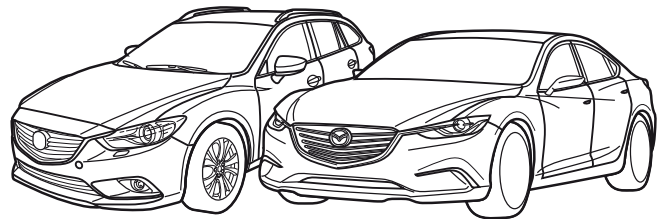

MAZDA 3 BL

JMZBM *****

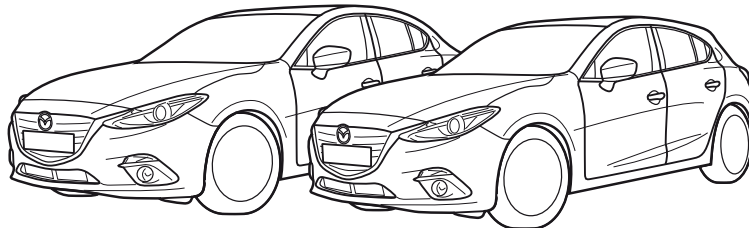

Part Number: KD53-V1-370
GHR1-V1-370
BJD9-V1-370

CX-5
MAZDA 6
MAZDA 3

Date: 18-03-2014

© Copyright MAZDA

Sheet 1 of 10

Expert Fitment Required
Montage durch Fachwerkstatt erforderlich
Montaje sólo por el concesionario
Montage par spécialiste nécessaire
E' necessario in officina specializzata
Especialista em montagem requerido
Montage door vakman nodig
Montage ved professionelt værksted påkrævet
Nødvendig med montering fra fagvejværksted
Verkstadsmontage erfordras
Asennus tarpeen merkkikorjaamossa
Montáž ve specializované dílně nutná
A szereléshez szakműhely kell
Konieczny montaż przez warsztat specjalistyczny
Να τοποθεί απο συνεργείο
Необходима установка специалистами



- (EN) Location/Position Arrow
- (DE) Positionspfeil
- (ES) Flecha de posición
- (FR) Flèche de Position
- (IT) Freccia di posizione
- (PT) Flexa de posição
- (NL) Lokatie/Positie pijl
- (DA) Lokaliseringspil
- (NO) Posisjonspil
- (SV) Positionspil
- (FI) Paikannusnuoli
- (CS) Šipka na pozici
- (HU) Helyzetjelző nyíl
- (PL) Strzałka położenia
- (EL) Βέλος θέσης
- (RU) Позиция



- (EN) Movement Arrow
- (DE) Bewegungspfeil
- (ES) Flecha de movimiento
- (FR) Flèche indiquant sens du mouvement
- (IT) Freccia di movimento
- (PT) Flexa de movimento
- (NL) Richtingspijl
- (DA) Bevægelsespil
- (NO) Bevegelsespil
- (SV) Rörelsepil
- (FI) Liikesuuntanuoli
- (CS) Šipka pohybu
- (HU) Mozgásirányjelző nyíl
- (PL) Strzałka kierunku ruchu
- (EL) Βέλος κίνησης
- (RU) Стрелка по направлению



- (GB) Look/See
- (D) Siehe
- (E) Ver
- (F) Voir
- (I) Vedere
- (P) Cf.
- (NL) Kijken naar
- (DK) Se
- (N) Se
- (S) Se
- (F) Katso
- (CZ) Viz
- (H) Lásd
- (PL) Patrz
- (GR) Βλέπω
- (RUS) См.



- (GB) Warning
- (D) Achtung
- (E) Atención
- (F) Attention
- (I) Attenzione
- (P) Atenção
- (NL) Let op
- (DK) Bemærk
- (N) Pass på
- (S) Varning
- (SF) Huomio
- (CZ) Pozor
- (H) Figyelem
- (PL) Uwaga
- (GR) Προσοχή
- (RUS) Осторожно



- (GB) See Workshop Manual
- (D) Siehe Werkstatthandbuch
- (E) Ver manual de taller
- (F) Voir Manuel d'atelier
- (I) Vedere manuale officina
- (P) Cf. o manual da oficina
- (NL) Zie werkplaatshandboek
- (DK) Se værkstedshåndbog
- (N) Se verkstedshåndboka
- (S) Se verkstadshandboken
- (F) Katso korjaamon käsikirjasta
- (CZ) Viz dílenskou příručku
- (H) Lásd a Műhely-kézikönyvből
- (PL) Patrz podręcznik warsztatowy
- (GR) λάπε Εγχειρίδιο Συνεργείου
- (RUS) Смотри руководство для мастерской



- (GB) Degrease
- (D) Entfetten
- (E) Desengrasar
- (F) Dégraisser
- (I) Sgrassare
- (P) Desengordurar
- (NL) Ontvetten
- (DK) Fjerne fedt
- (N) To bort fettet
- (S) Avfettning
- (SF) Rasvanpoisto
- (CZ) Odmastit
- (H) Zsírtalanítás
- (PL) Odtłuszczyć
- (GR) Απολιπανση
- (RUS) Обезжирить

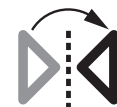

- (GB) Mirror image
- (D) Spiegelbild
- (E) Imagen simétrica
- (F) Image de miroir
- (I) Immagine dello specchio
- (P) Imagem do espelho
- (NL) Mirror beeld
- (DK) Spejlbilde
- (N) Speilbilde
- (S) Spegelbild
- (SF) Peilikuva
- (CZ) Věrný obraz
- (H) Tükürcép
- (PL) Odbicie lustrzane
- (GR) εικ ανακθρεφτών
- (RUS) Зеркальное отражение

CX-5 KE/GH

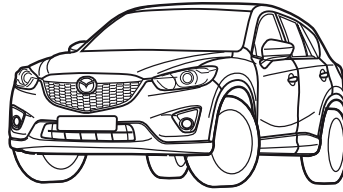

KD53-V1-370

MAZDA 6 GJ

MAZDA 6 GH
JMZGJ *****120400 →

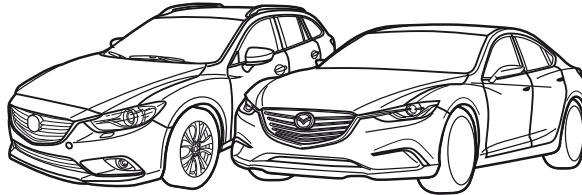

GHR1-V1-370

MAZDA 3 BL
JMZBM *****

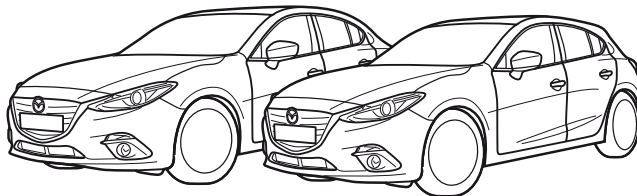

BJD9-V1-370

A



1x

B



1x

C



1x

D



1x

E

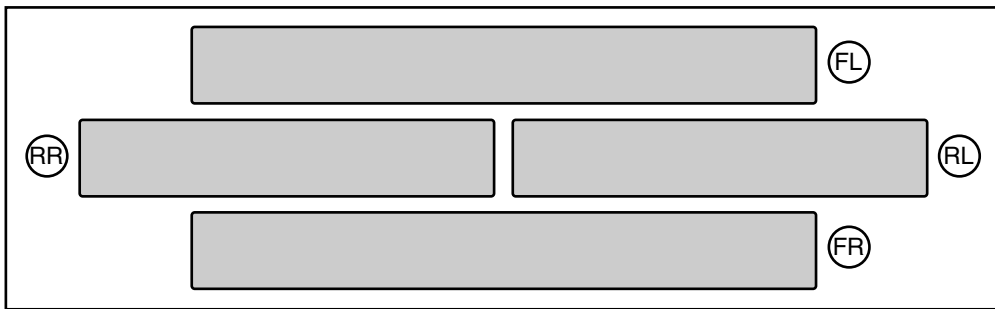

1x

Tools

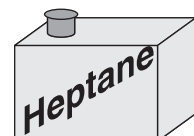
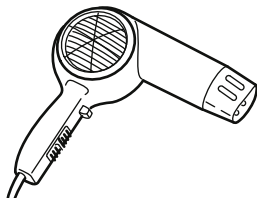

i
Info

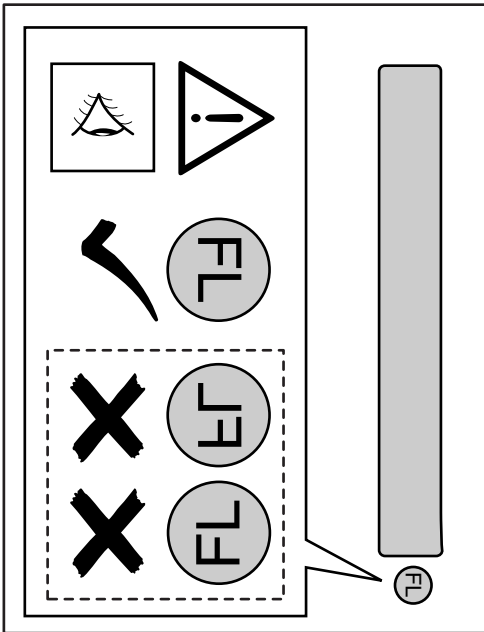

Diagram of the front-left wheel area. It features a vertical grey bar with a callout bubble containing the text 'FL'. To the right of the bar is a dashed box containing two 'X' marks and two circles labeled 'FL'. Above the dashed box is a checkmark and a circle labeled 'FL'. To the left of the bar are two warning icons: a closed eye and a triangle with an exclamation point.

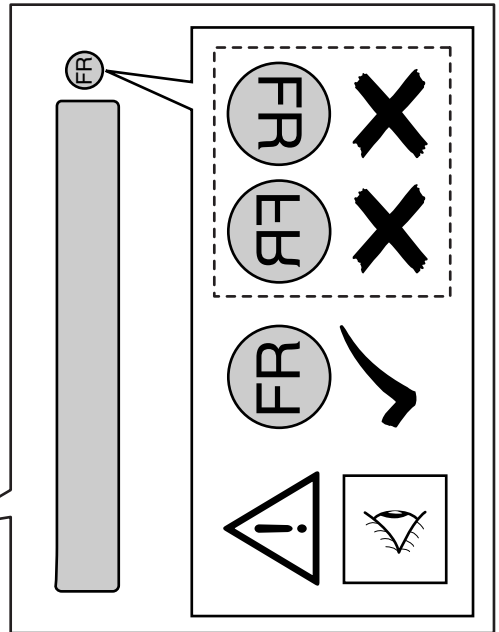
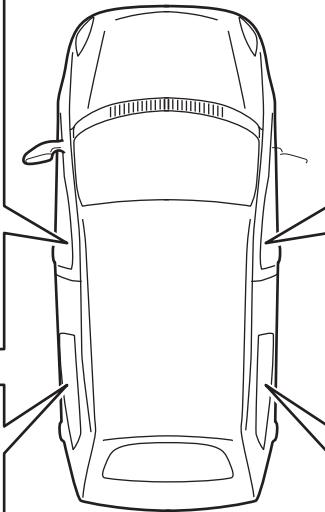

Diagram of the front-right wheel area. It features a vertical grey bar with a callout bubble containing the text 'FR'. To the right of the bar is a dashed box containing two 'X' marks and two circles labeled 'FR'. Above the dashed box is a checkmark and a circle labeled 'FR'. To the left of the bar are two warning icons: a triangle with an exclamation point and a closed eye.

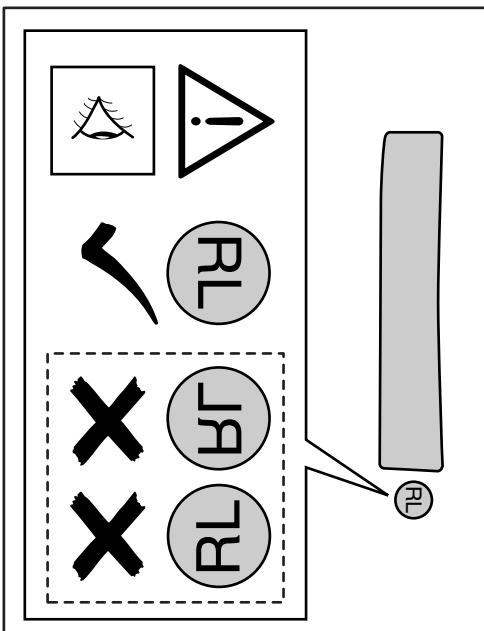

Diagram of the rear-left wheel area. It features a vertical grey bar with a callout bubble containing the text 'RL'. To the right of the bar is a dashed box containing two 'X' marks and two circles labeled 'RL'. Above the dashed box is a checkmark and a circle labeled 'RL'. To the left of the bar are two warning icons: a closed eye and a triangle with an exclamation point.

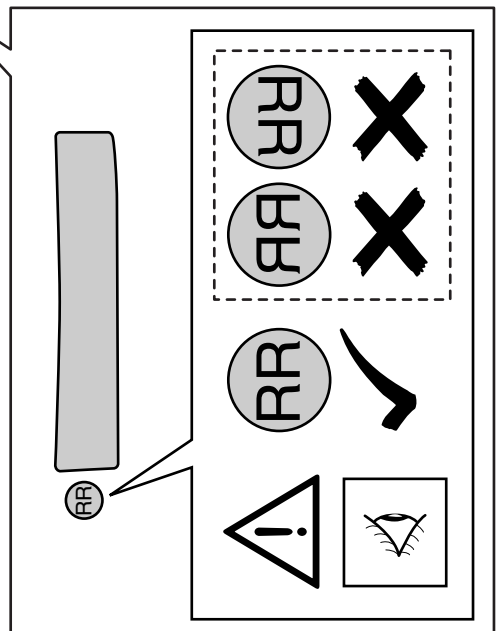
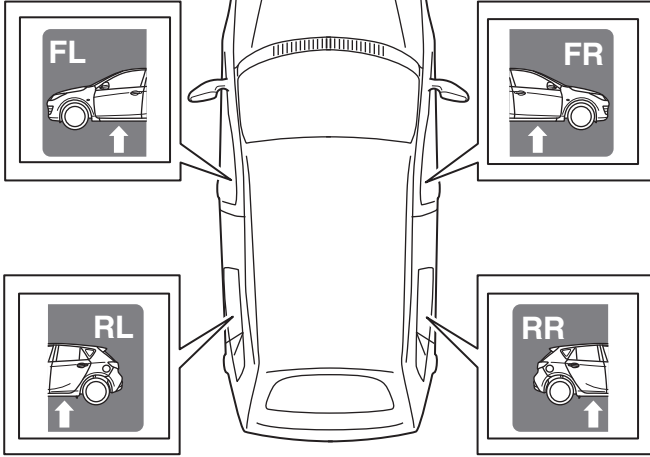

Diagram of the rear-right wheel area. It features a vertical grey bar with a callout bubble containing the text 'RR'. To the right of the bar is a dashed box containing two 'X' marks and two circles labeled 'RR'. Above the dashed box is a checkmark and a circle labeled 'RR'. To the left of the bar are two warning icons: a triangle with an exclamation point and a closed eye.



Info



+ 35°C

+ 16°C

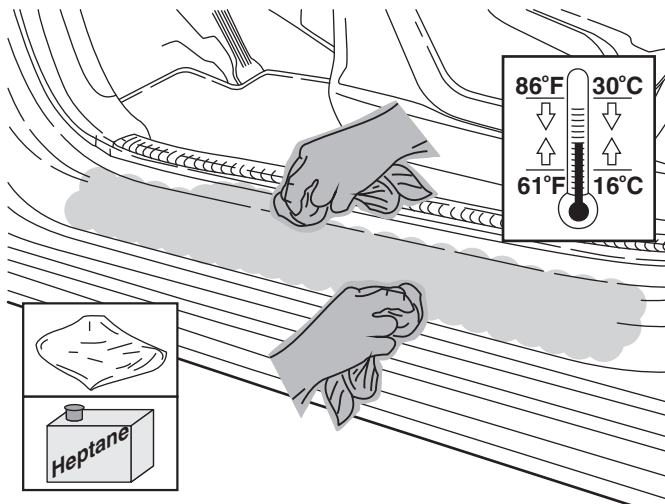
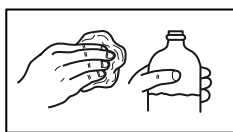
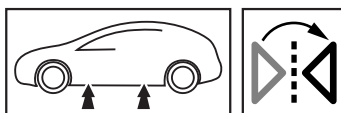
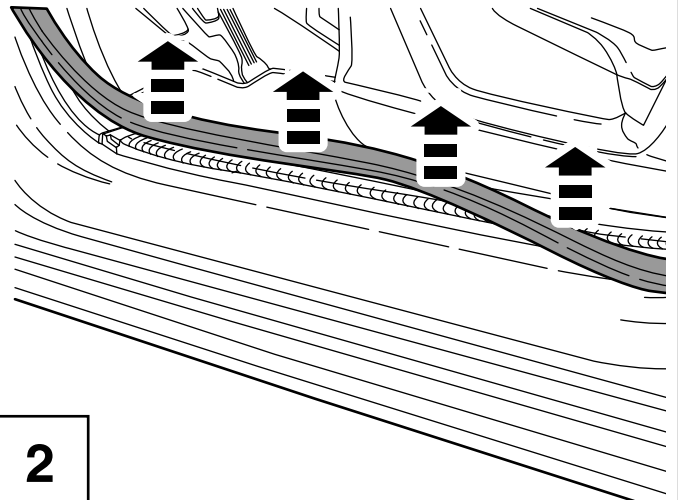
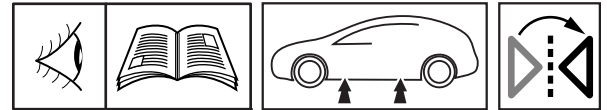
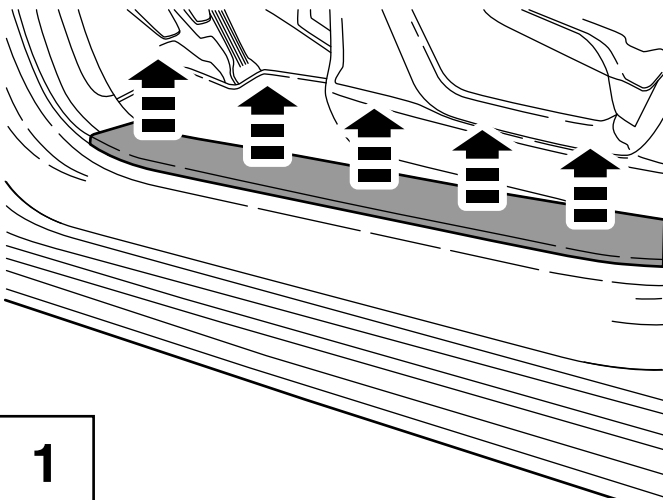
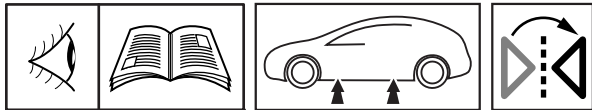
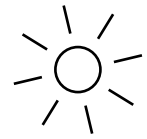

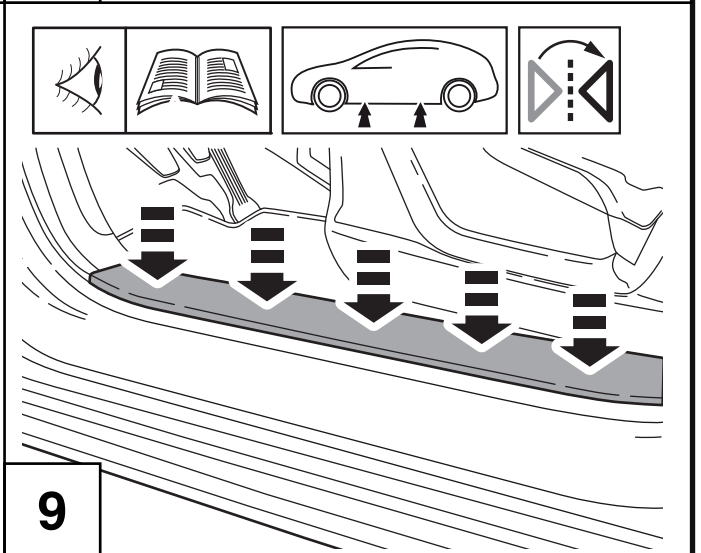
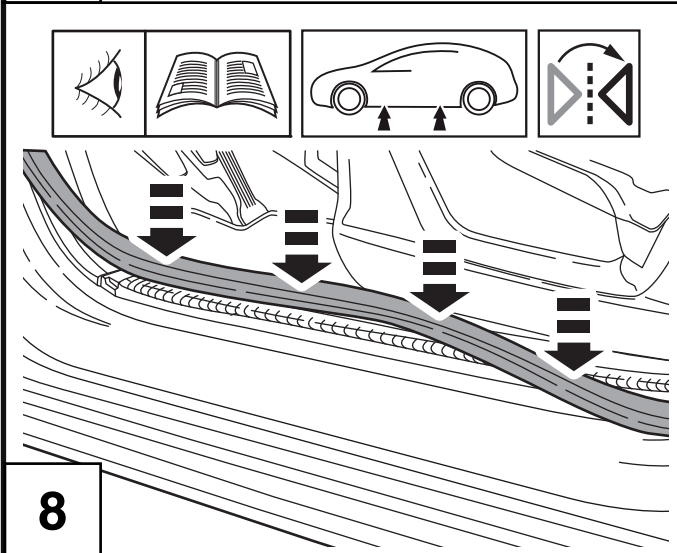
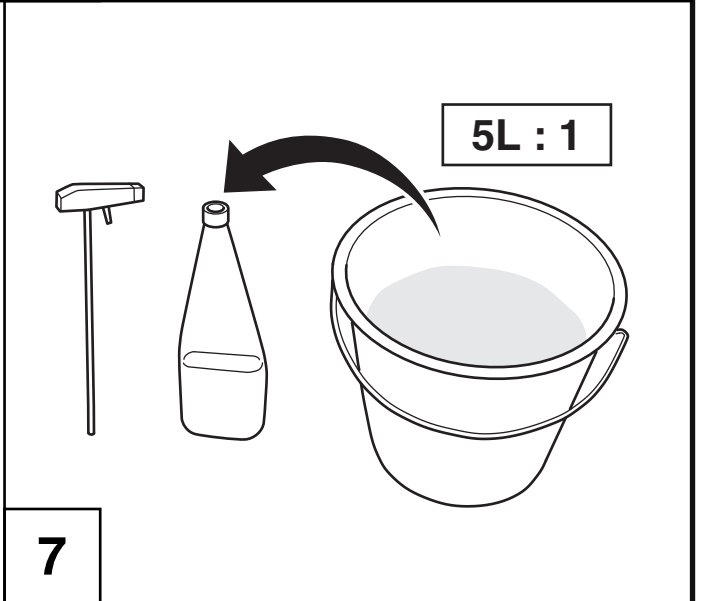
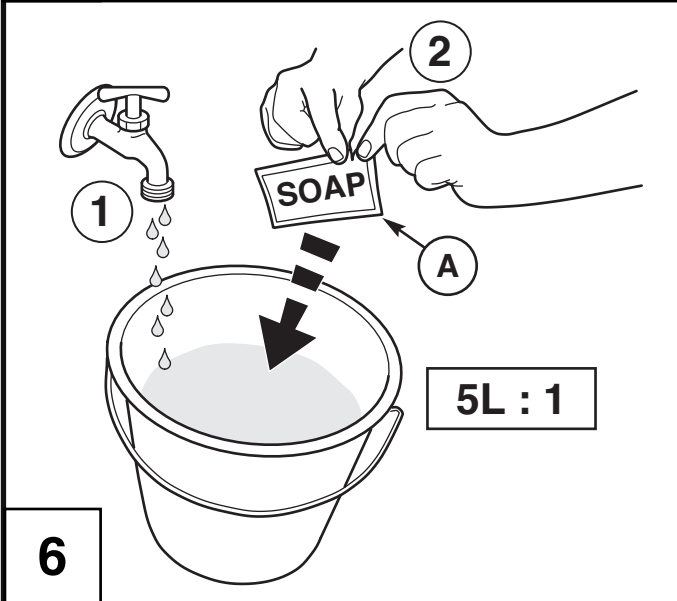
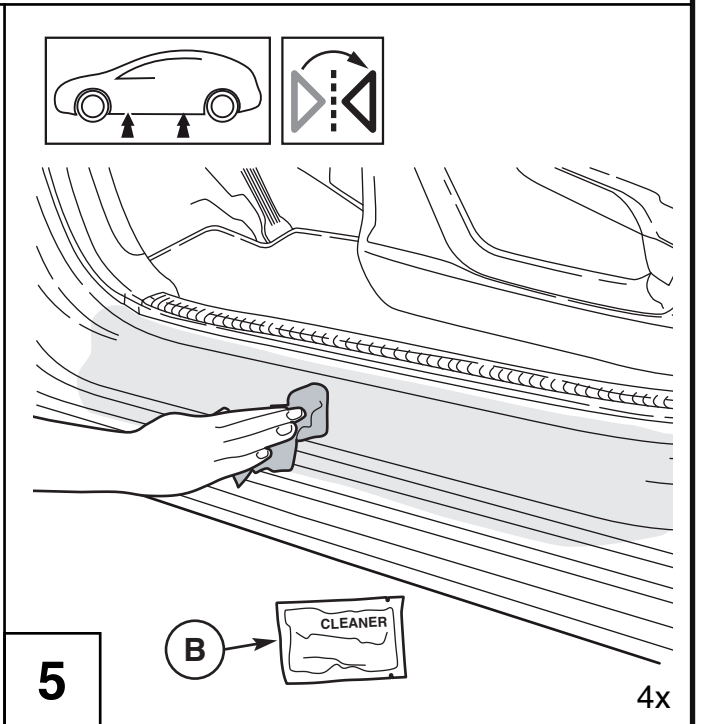
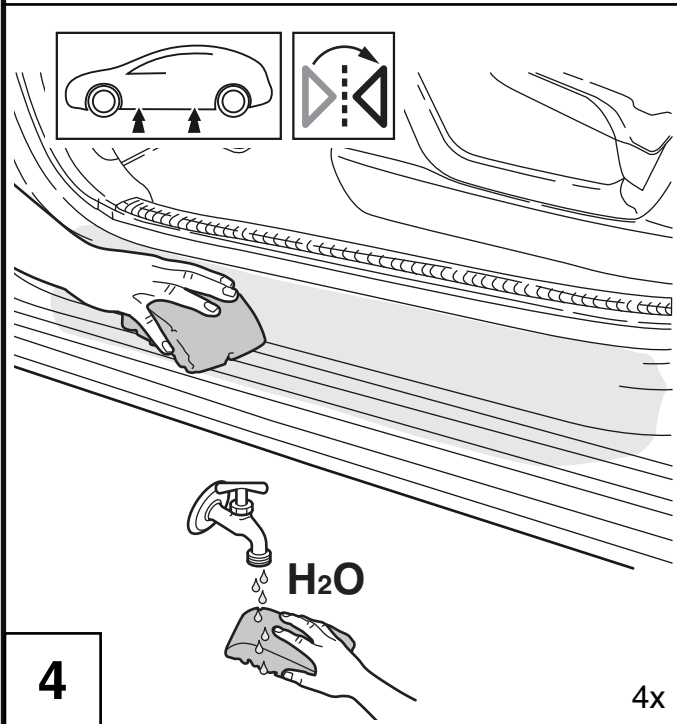

10

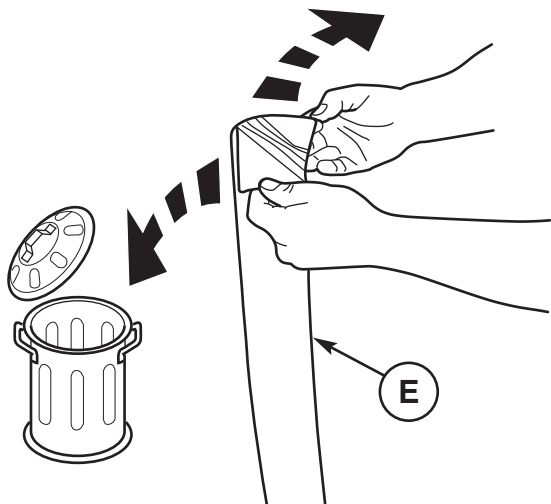

11

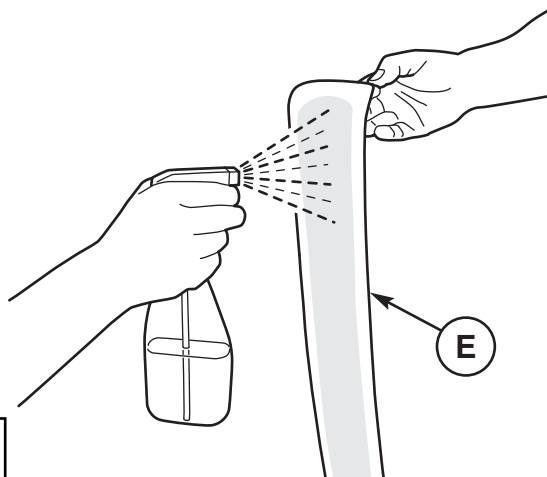

12

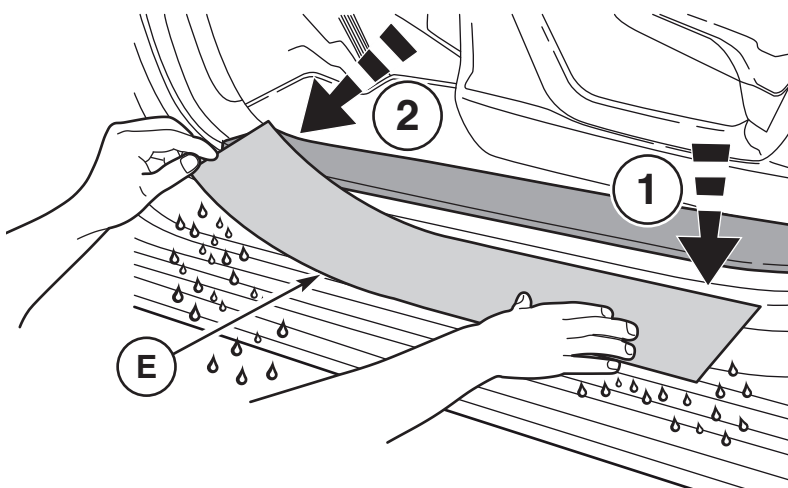

13

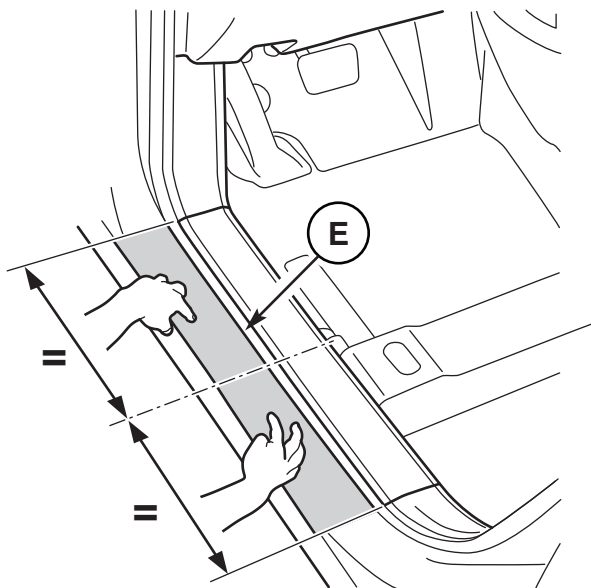

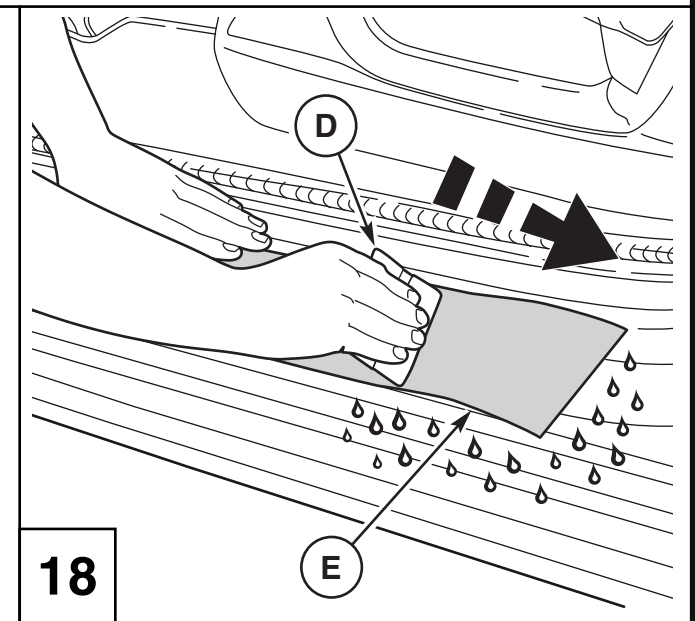
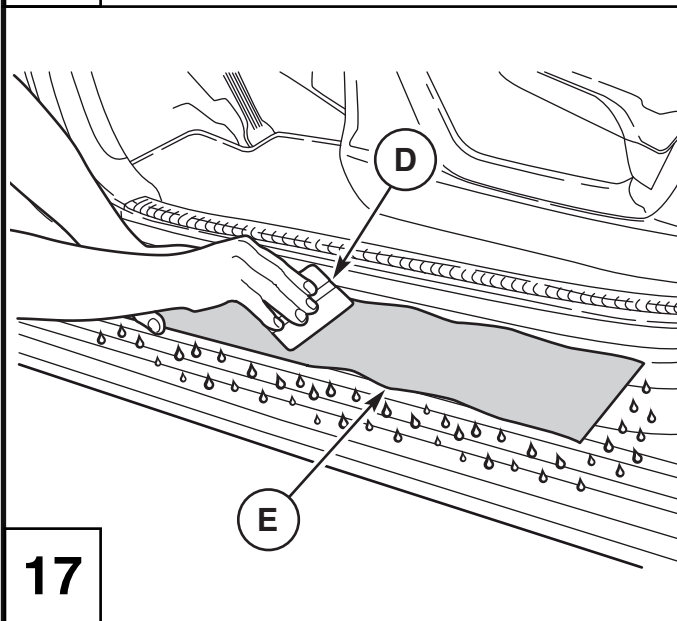
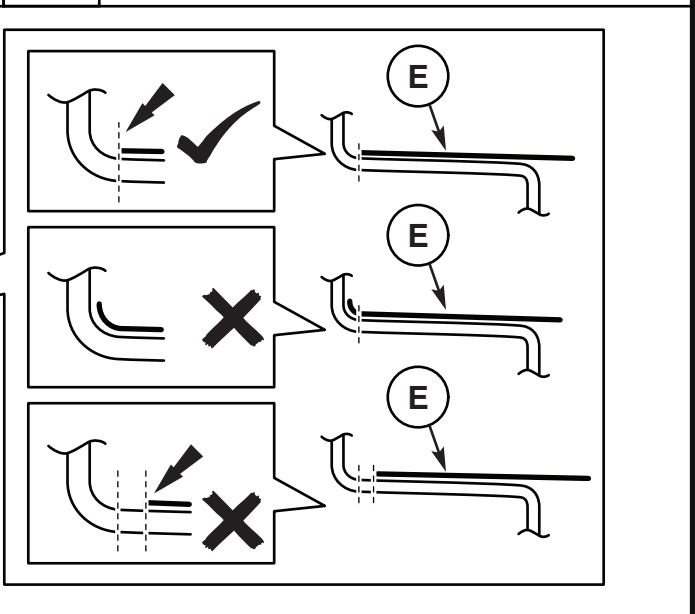
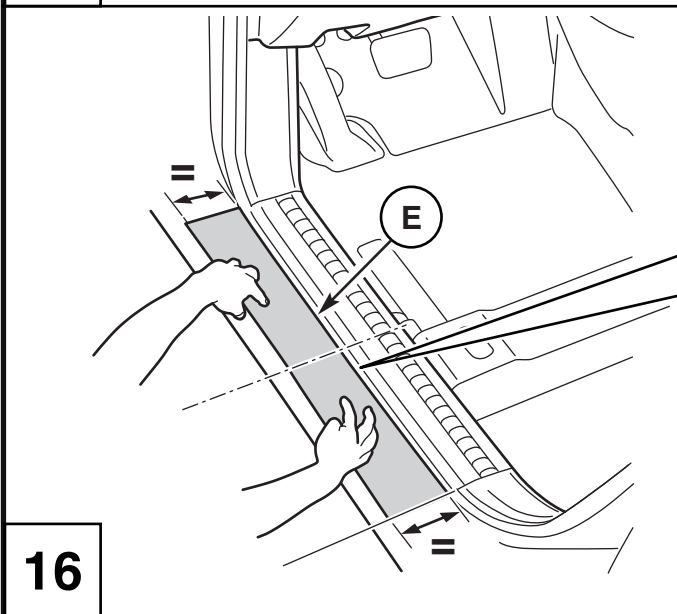
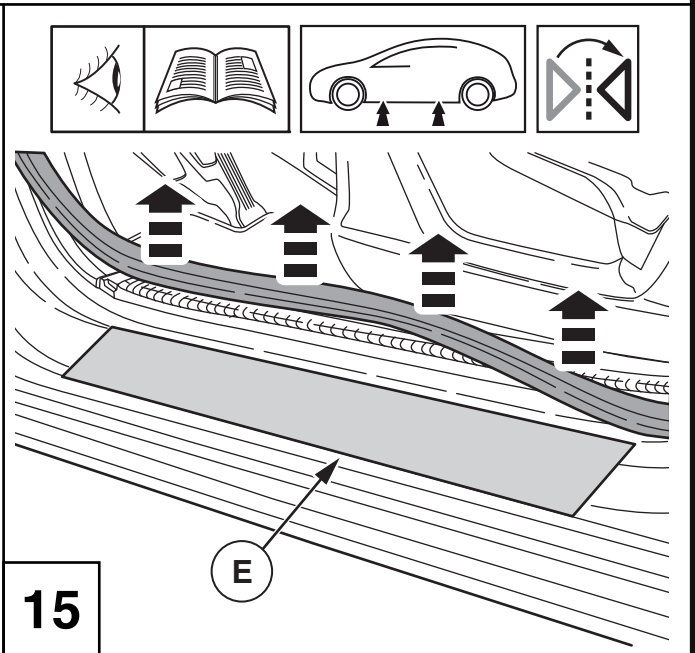
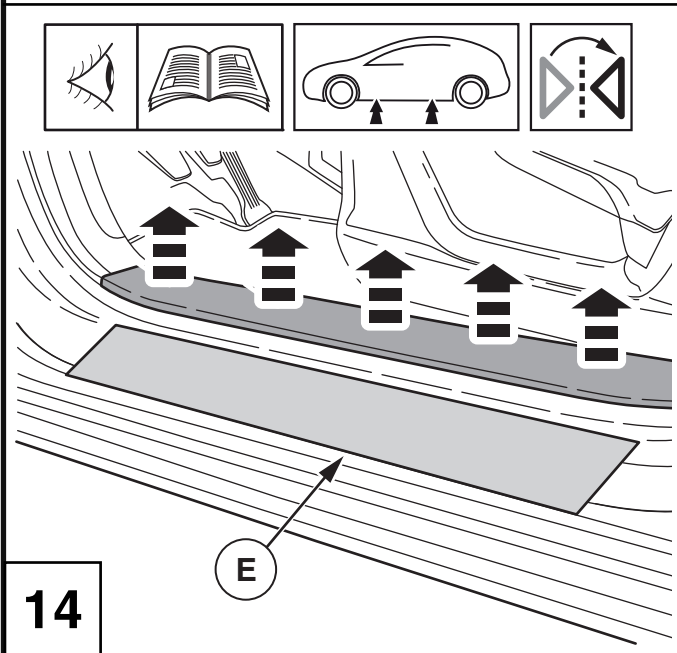

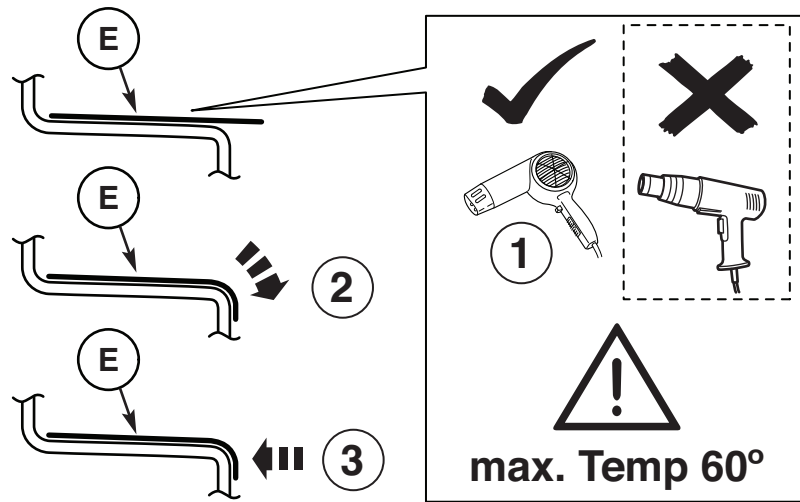

19

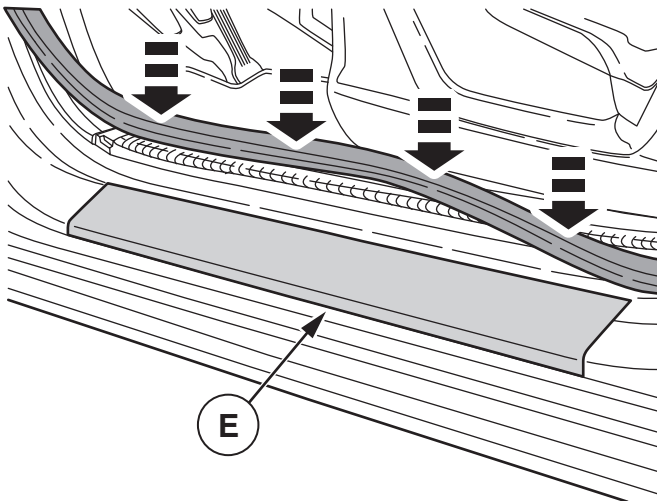
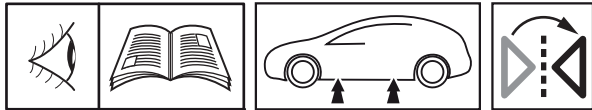

20

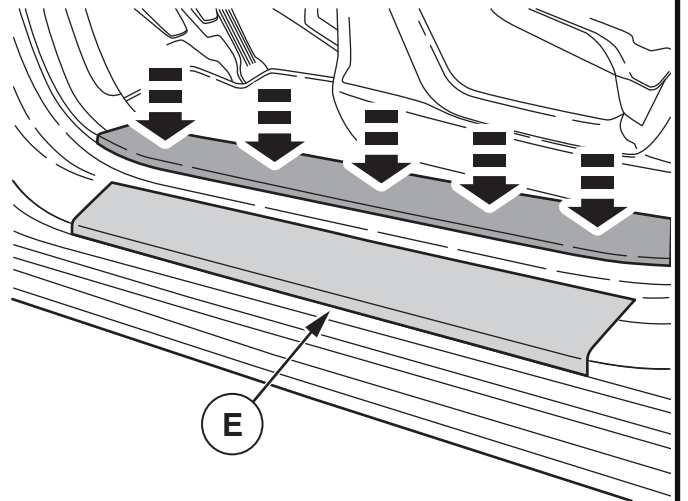
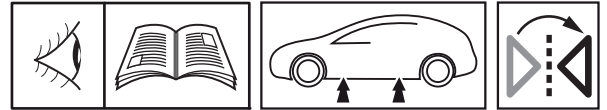

21

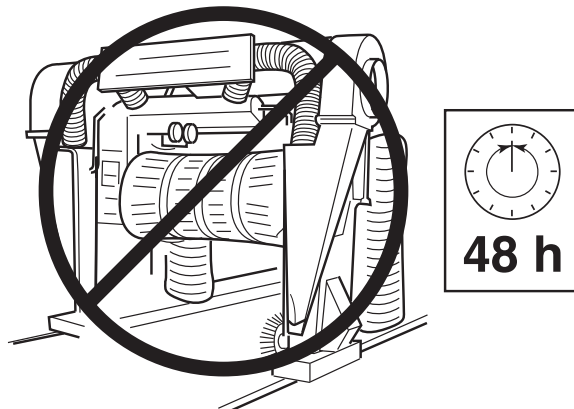

22

Subject to alternation without notice
 Technische Änderungen vorbehalten
 Reservadas modificaciones técnicas
 Sous réserve de modifications techniques
 Con riserva di apportare modifiche tecniche
 Reservamo-nos o direito a alterações técnicas
 Technische wijzigingen voorbehouden
 Med forbehold for tekniske ændringer
 Tekniske forendringer forbeholdes
 Med reservation för tekniska ändringar
 Tekniset muutokset pidätetään
 Technické zmeny vyhrazeny
 A változtatások technika jogát fenntartjuk
 Zmiany techniczne zastrzeżone
 Επιφύλασσομεθα για αλλαγές
 Можно изменять без уведомления