



MAZDA

- GB** ENTRY PROTECTION FOIL
Installation Instruction
- D** EINSTIEGSLEISTENSCHUTZFOLIE
Einbauanleitung
- E** SIDE PELÍCULA DE PROTECCIÓN ALFÉIZAR
Instrucciones de montaje
- F** CÔTÉ FILM DE PROTECTION DE SEUIL
Instructions de montage
- I** SIDE PELLICOLA DI PROTEZIONE DAVANZALE
Istruzioni di montaggio
- P** PELÍCULA DE PROTEÇÃO SOLEIRA SIDE
Instruções de montagem
- NL** DORPELVERBREDERS BESCHERMFOLIE
Inbouw-instructie
- DK** VENTILATIONSGITTER BESKYTTELSE FILM
Monteringsvejledning
- N** VRIDERE FILM
Monteringsveiledning

- S** SIDO SILL SKYDDSFILM
Monteringsanvisning
- SF** SIVUHELMAVERHOUKSET SUOJAKALVO
Asennusohje
- CZ** BOČNÍ PRÁH OCHRANNÁ FÓLIE
Návod k montáži
- H** OLDALSÓ PÁRKÁNY FILM
Beszerelési utasítás
- PL** FOLIA OCHRONNA BOCZNA PARAPET
Instrukcja zabudowy
- GR** ΠΛΕΥΡΑ ΤΗΣ ΜΕΜΒΡΑΝΗΣ ΠΕΡΒΑΖΙ ΠΡΟΣΤΑΣΙΑ
Οδηγίες τοποθέτησης
- RUS** СТОРОНА ФИЛЬМ ПОДОКОННИК ЗАЩИТА
инструкция по установке
- SVK** VSTUPNÁ OCHRANNÁ FÓLIA
Návod na inštaláciu

[SDN]

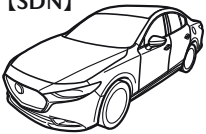

[5HB]

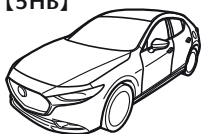

MAZDA 3 | BP

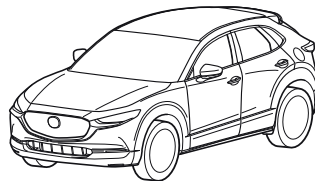

MAZDA CX-30 | DM

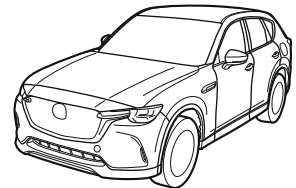

MAZDA CX-60 | KH01

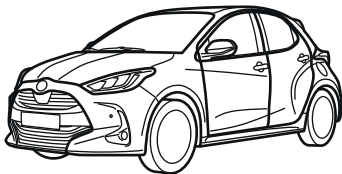

MAZDA 2 HYBRID | ZV

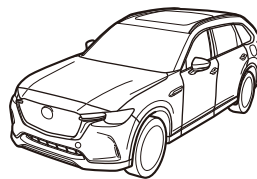

MAZDA CX-80 | KL01

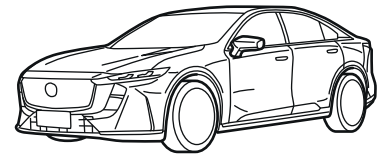

MAZDA 6e | GN

Part Number: BDEN-V1-360
BDEL-V1-360
DFR5-V1-360
KR9P-V1-360
ZR74-V1-360
KJH3-V1-360
GJBK-V1-360

MAZDA 3 (5HB)
MAZDA 3 (SDN)
MAZDA CX-30
MAZDA CX-60
MAZDA 2 HYBRID
MAZDA CX-80
MAZDA 6e

Date: 26-02-2025

© Copyright MAZDA

Sheet 1 of 10

Expert Fitment Required
Montage durch Fachwerkstatt erforderlich
Montaje sólo por el concesionario
Montage par spécialiste nécessaire
E' necessario in officina specializzata
Especialista em montage requerido
Montage door vakman nodig
Montage ved professionelt værksted påkrævet
Nødvendig med montering fra fagvejværksted
Værkstedsmontage erfordras
Asennus tarpeen merkkikorjaamossa
Montáž ve specializované dílně nutná
A szereléshez szakmúhely kell
Konieczny montaż przez warsztat specjalistyczny
Να τοποθετεί απο συνεργείο
Необходима установка специалистами
Vyžaduje sa odborné vybavenie



- (GB)** Location/Position Arrow
- (D)** Positionspfeil
- (E)** Flecha de posición
- (F)** Flèche de Position
- (I)** Freccia di posizione
- (P)** Flexa de posição
- (NL)** Lokatie/Positie pijl
- (DK)** Lokaliseringspil
- (N)** Posisjonspil
- (S)** Positionpil
- (SF)** Paikannusnuoli
- (CZ)** Šípka na pozici
- (H)** Helyzetjelző nyíl
- (PL)** Strzałka położenia
- (GR)** Βέλος θέσης
- (RUS)** Позиция
- (SVK)** Šípka polohy



- (GB)** Movement Arrow
- (D)** Bewegungspfeil
- (E)** Flecha de movimiento
- (F)** Flèche indiquant sens du mouvement
- (I)** Freccia di movimentov
- (P)** Flexa de movimento
- (NL)** Richtingspijl
- (DK)** Bevægelsespil
- (N)** Bevegelsespil
- (S)** Rörelsepil
- (SF)** Liikesuuntanuoli
- (CZ)** Šípka pohybu
- (H)** Mozgásirányjelző nyíl
- (PL)** Strzałka kierunku ruchu
- (GR)** Βέλος κίνησης
- (RUS)** Стрелка по направлению
- (SVK)** Šípka pohybu



- (GB)** Look/See
- (D)** Siehe
- (E)** Ver
- (F)** Voir
- (I)** Vedere
- (P)** Cf.
- (NL)** Kijken naar
- (DK)** Se
- (N)** Se
- (S)** Se
- (F)** Katso
- (CZ)** Viz
- (H)** Lásd
- (PL)** Patrz
- (GR)** Βλέπω
- (RUS)** Смотрите
- (SVK)** Pozerať



- (GB)** Throw away
- (D)** Entsorgen
- (E)** Tratamiento de residuos
- (F)** Jeter aux déchets
- (I)** Smaltire
- (P)** Eliminar
- (NL)** Weggooien
- (DK)** Affald
- (N)** Avskaffe
- (S)** Ta hand om avfallet
- (SF)** Hävittää
- (CZ)** Vyhodit
- (H)** Távolítsa el
- (PL)** Usunąć jako odpad
- (GR)** Αποσύρση
- (RUS)** Выбросите
- (SVK)** Zahodit'



- (GB)** Warning
- (D)** Achtung
- (E)** Atención
- (F)** Attention
- (I)** Attenzione
- (P)** Atenção
- (NL)** Let op
- (DK)** Bemærk
- (N)** Pass på
- (S)** Varning
- (SF)** Huomio
- (CZ)** Pozor
- (H)** Figyelem
- (PL)** Uwaga
- (GR)** Προσχή
- (RUS)** Осторожно
- (SVK)** Výstraha



- (GB)** See Workshop Manual
- (D)** Siehe Werkstatthandbuch
- (E)** Ver manual de taller
- (F)** Voir Manuel d'atelier
- (I)** Vedere manuale officina
- (P)** Cf. o manual da oficina
- (NL)** Zie werkplaatshandboek
- (DK)** Se værkstedshåndbog
- (N)** Se verkstedshåndboka
- (S)** Se verkstadshandboken
- (F)** Katso korjaamon käsikirjasta
- (CZ)** Viz dílenskou příručku
- (H)** Lásd a Műhely-kézikönyvből
- (PL)** Patrz podręcznik warsztatowy
- (GR)** λάπε Εγχειρίδιο Συνεργείου
- (RUS)** Смотрите руководство для мастерской
- (SVK)** Pozrite si dielenskú príručku



- (GB)** Degrease
- (D)** Entfetten
- (E)** Desengrasar
- (F)** Dégraisser
- (I)** Sgrassare
- (P)** Desengordurar
- (NL)** Ontvetten
- (DK)** Fjerne fedt
- (N)** To bort fettet
- (S)** Avfetting
- (SF)** Rasvanpoisto
- (CZ)** Odmastit
- (H)** Zsírtalanítás
- (PL)** Odtłuszczyć
- (GR)** Απολιπανση
- (RUS)** Обезжирьте
- (SVK)** Odmastite



- (GB)** Mirror image
- (D)** Spiegelbild
- (E)** Imagen simétrica
- (F)** Image de miroir
- (I)** Immagine dello specchio
- (P)** Imagem do espelho
- (NL)** Mirror beeld
- (DK)** Spejlbilde
- (N)** Speilbilde
- (S)** Spegelbild
- (SF)** Peilikuva
- (CZ)** Věrný obraz
- (H)** Tükürcép
- (PL)** Odbicie lustrzane
- (GR)** εικ ανακθρεφτών
- (RUS)** Зеркальное отражение
- (SVK)** Zrkadlový obraz



MAZDA 3 BP

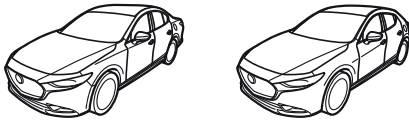

BDEN-V1-360 (5HB)
BDEL-V1-360 (SDN)

MAZDA CX-30 DM



DFR5-V1-360

MAZDA CX-60 KH01



KR9P-V1-360

MAZDA 2 HYBRID ZV



ZR74-V1-360

MAZDA CX-80 KL01



KJH3-V1-360

MAZDA 6e GN



GJBK-V1-360

Spare Part: 4100-77-005

A



1x

B



1x

C



1x

D



1x

E

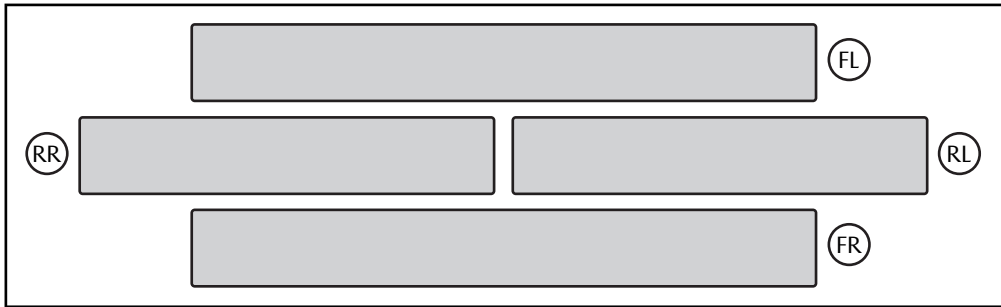



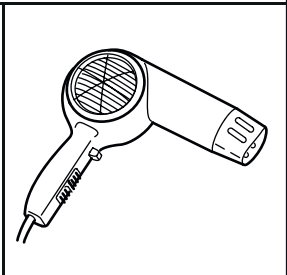
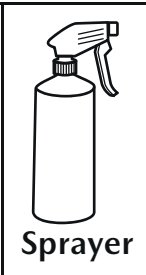
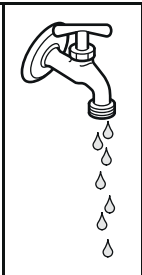
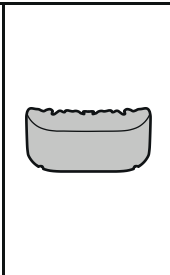
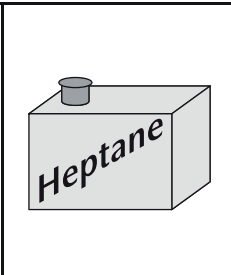
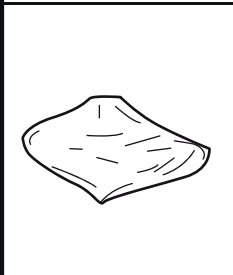

1x



Tools & Consumables





i
Info











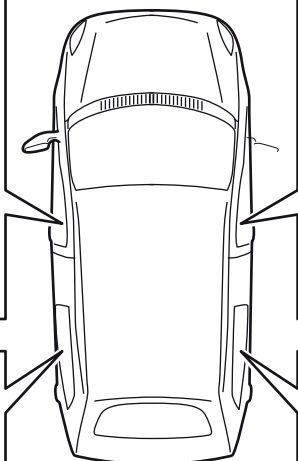





























































Info

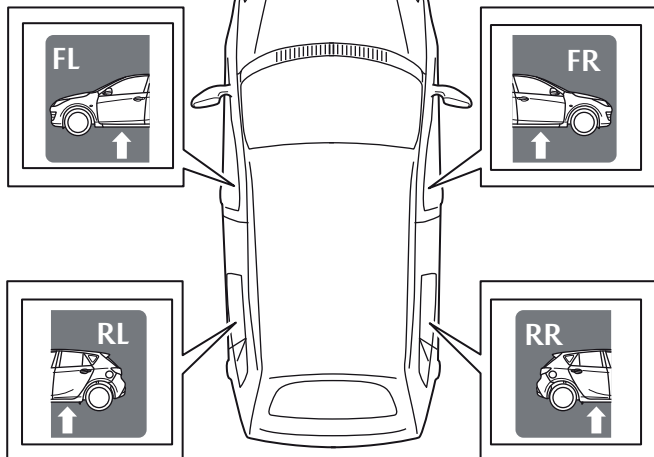

+ 30°C

+ 16°C

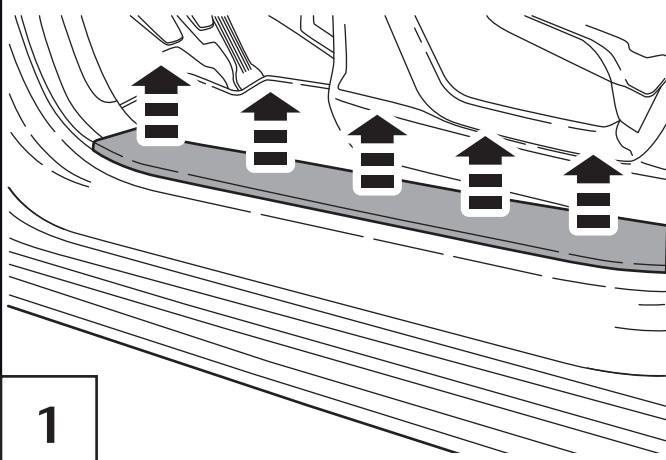
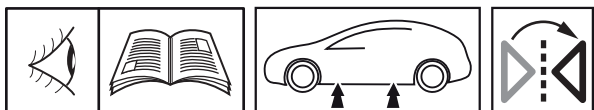
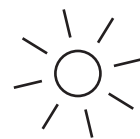

1

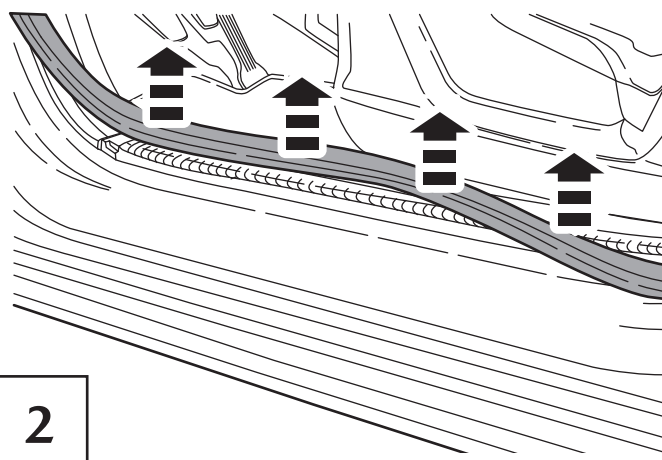
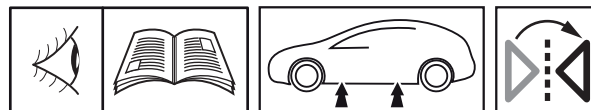

2

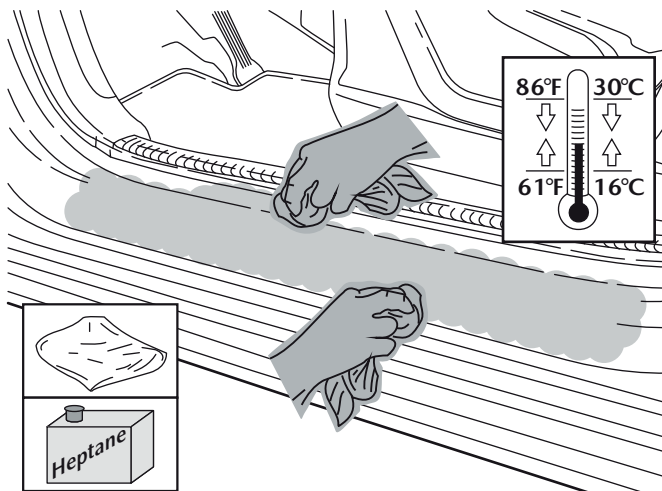
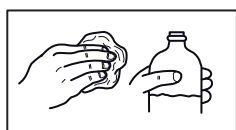
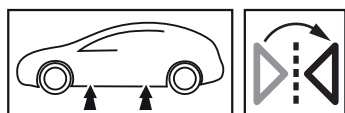

3

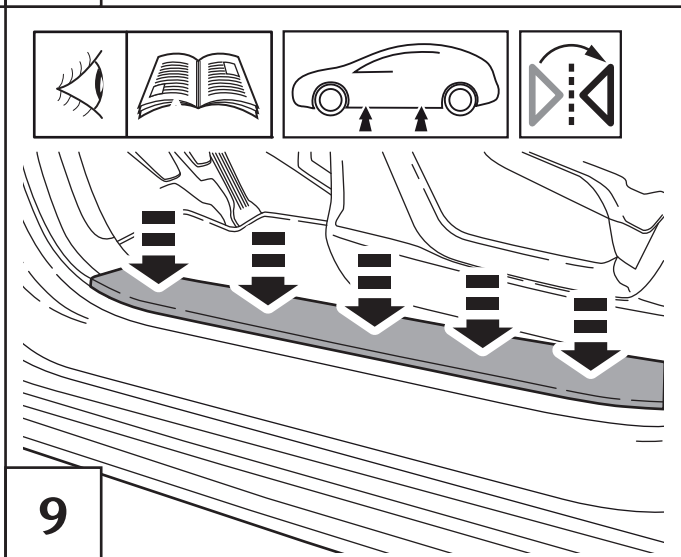
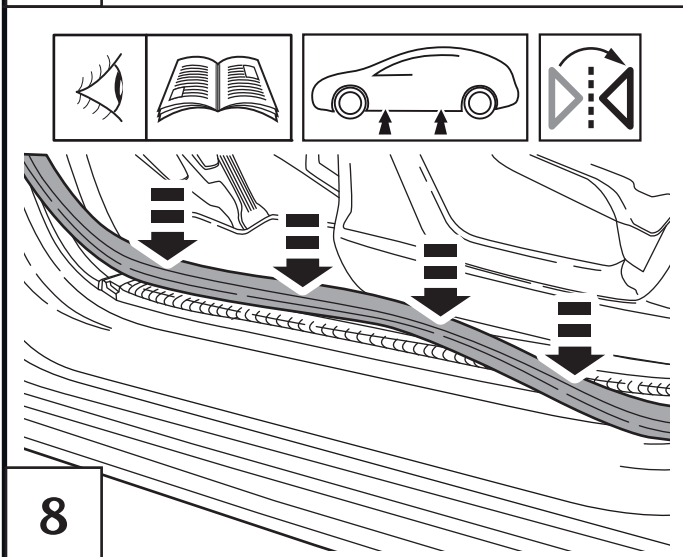
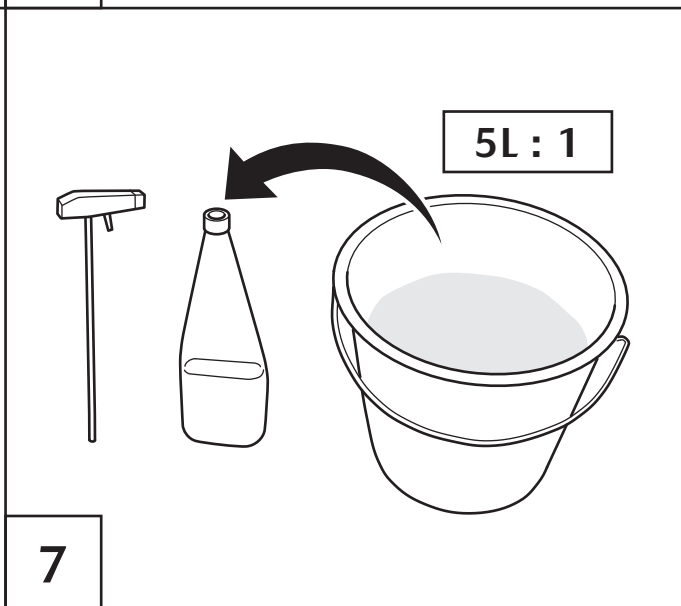
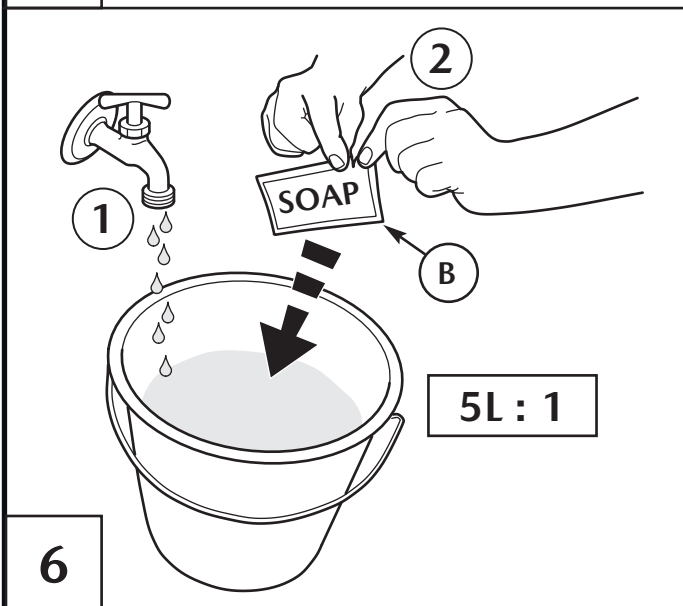
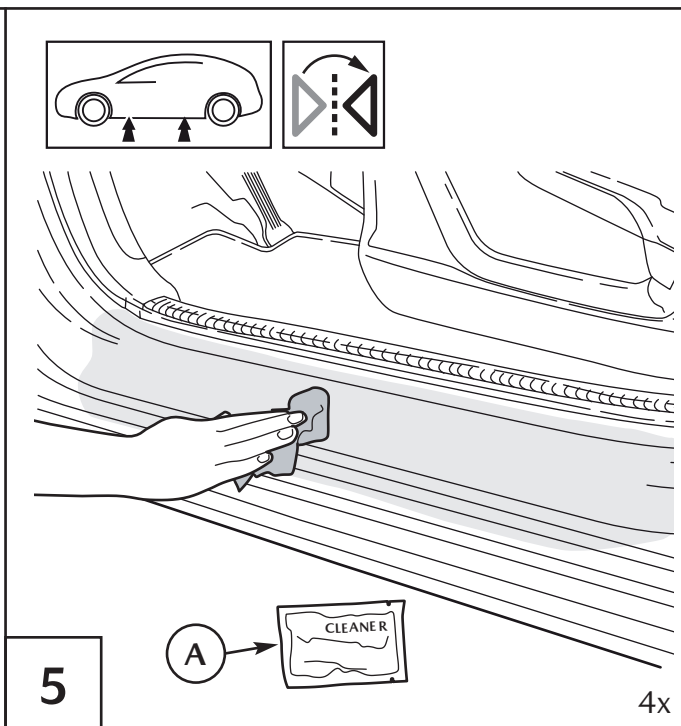
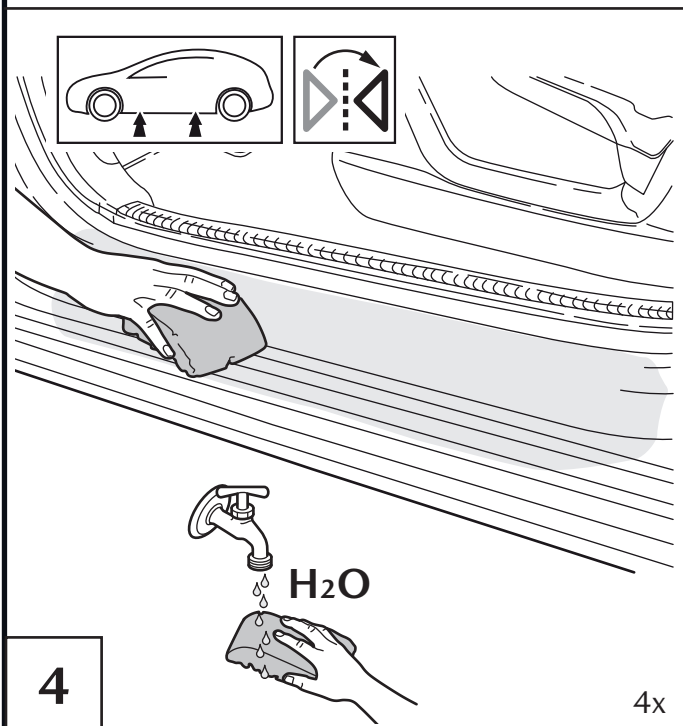

10

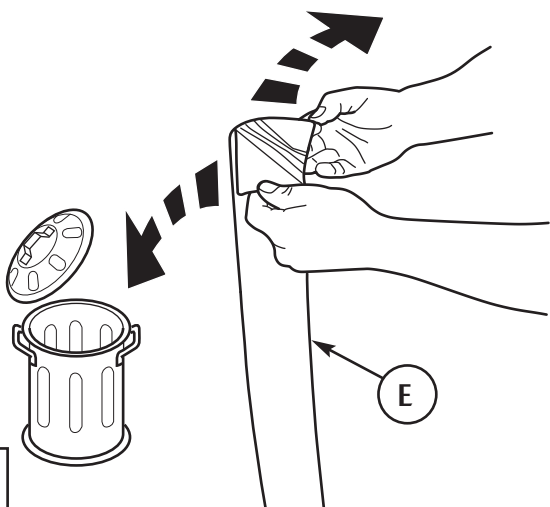

11

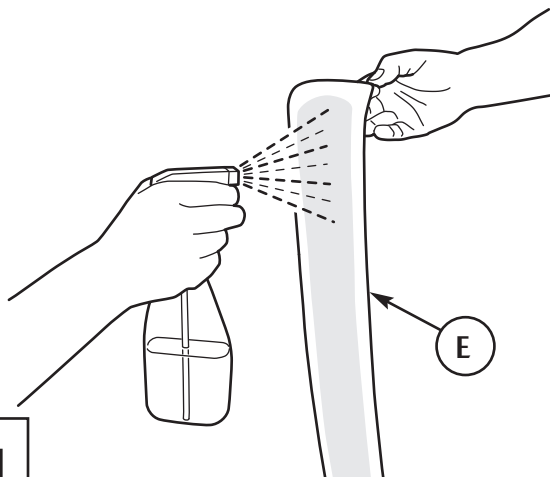

12

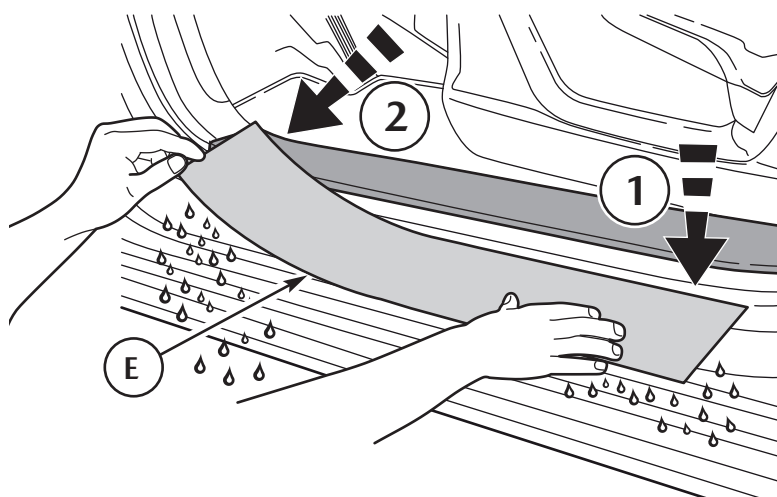

13

 NOT APPLICABLE FOR MAZDA 6e

 For MAZDA 6e
 14

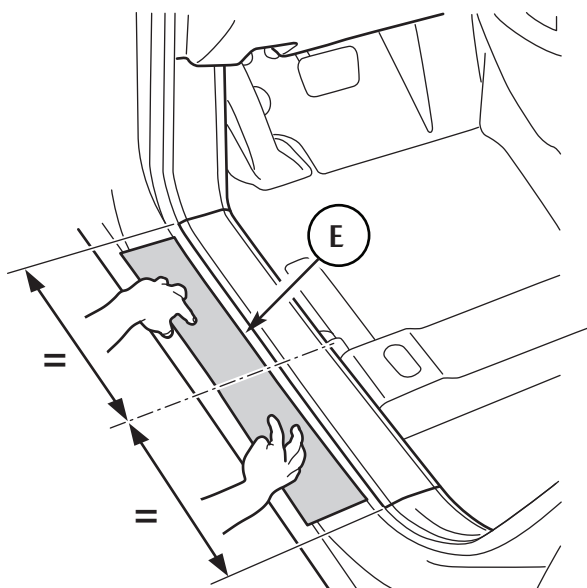

ONLY MAZDA 6e

0mm

E

FL

14

ONLY MAZDA 6e

90mm

E

RL

E

15

E

16

NOT APPLICABLE FOR MAZDA 6e

For MAZDA 6e

Info 18

E

17

E

E

E

ONLY MAZDA 6e

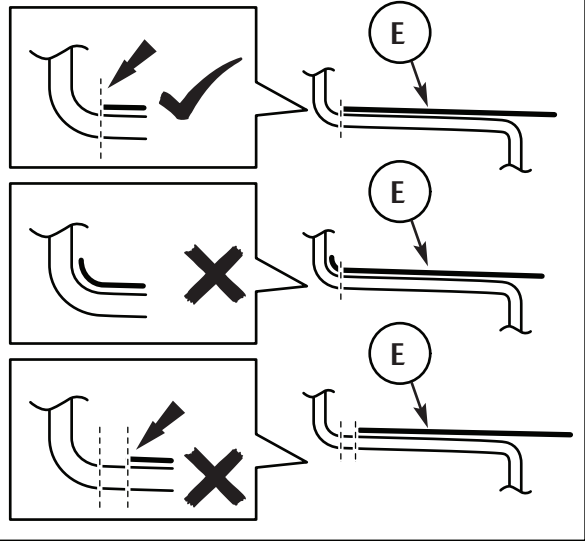
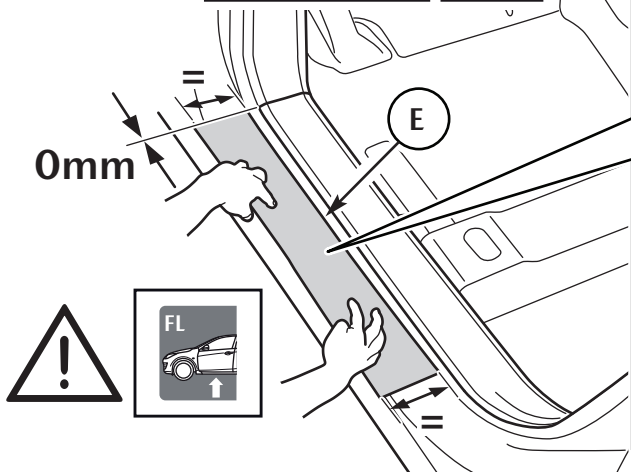
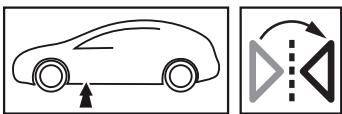

ONLY MAZDA 6e

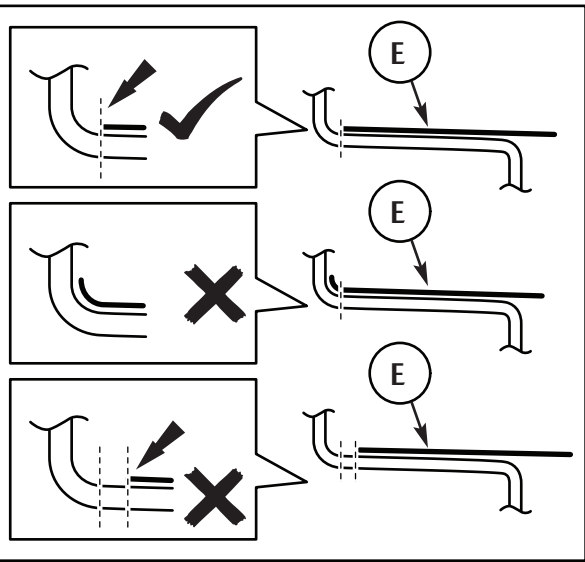
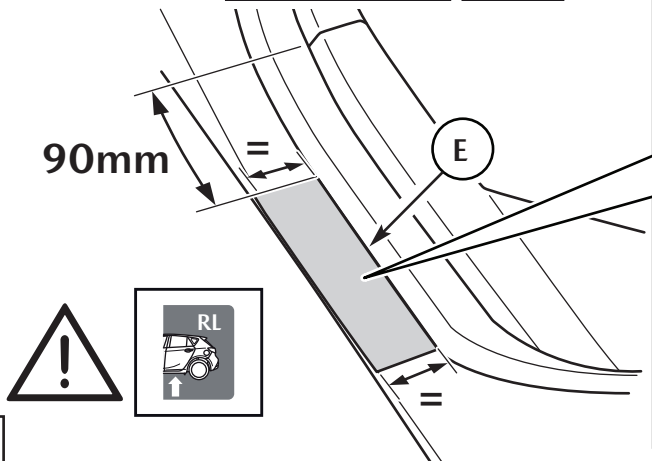
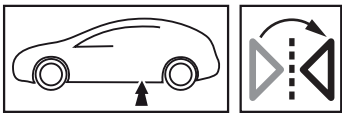

18

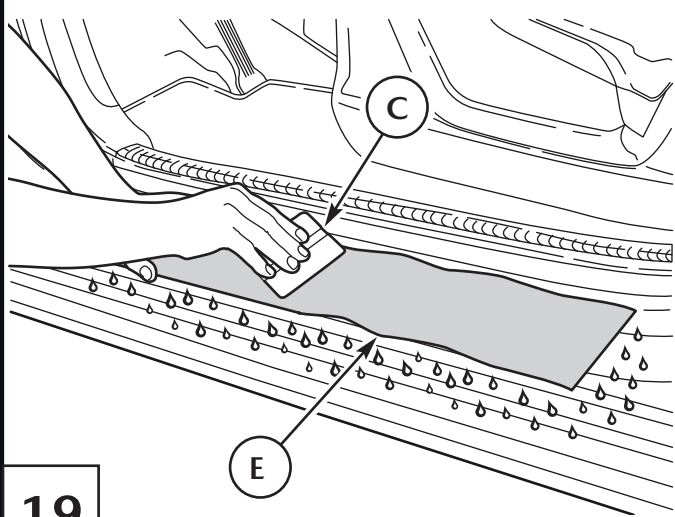

19

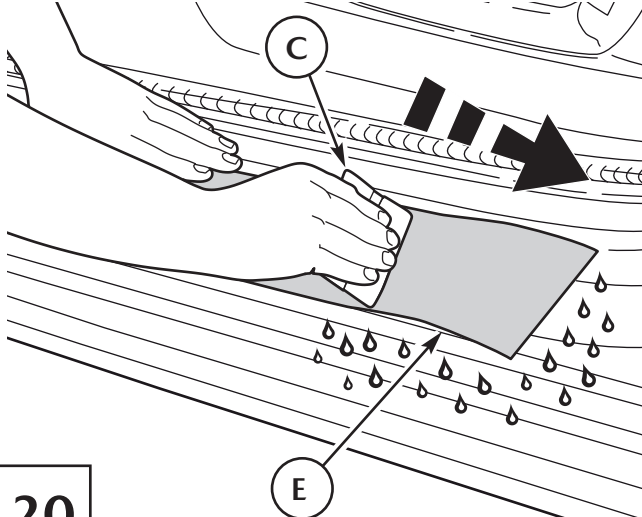

20

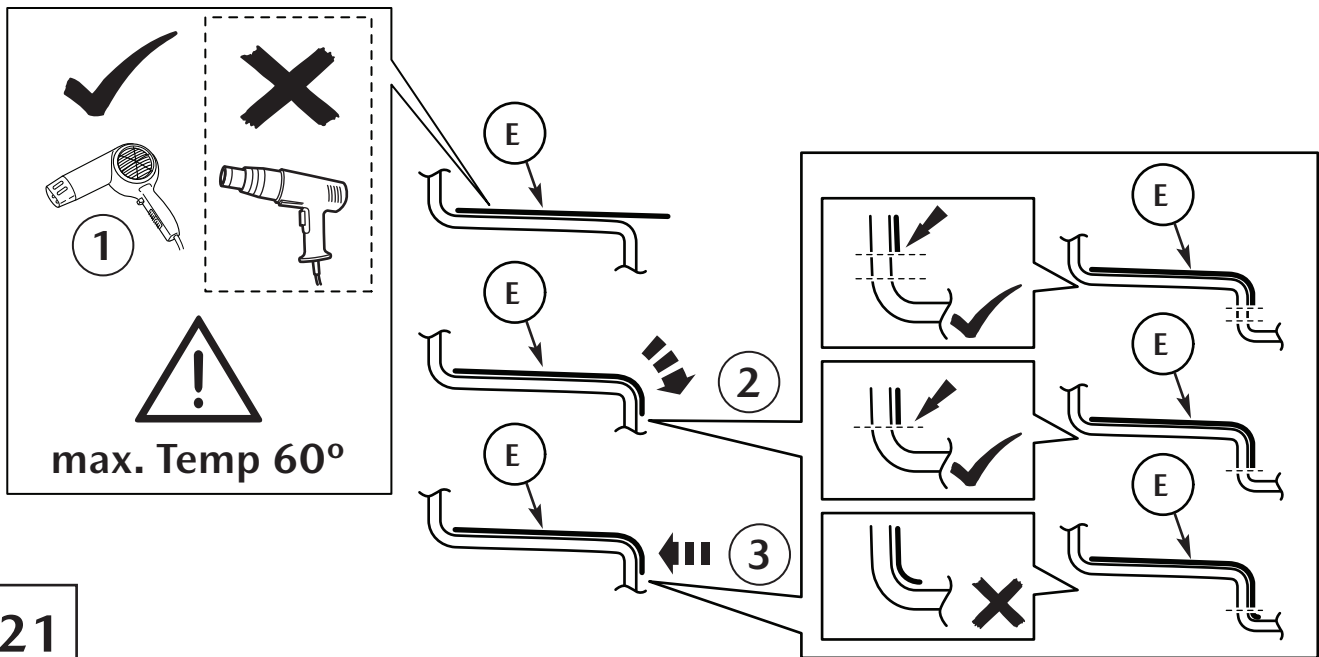

21

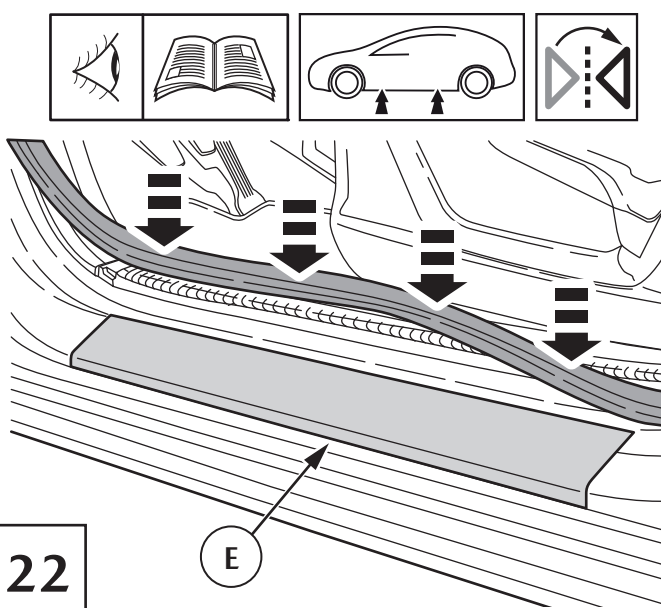

22

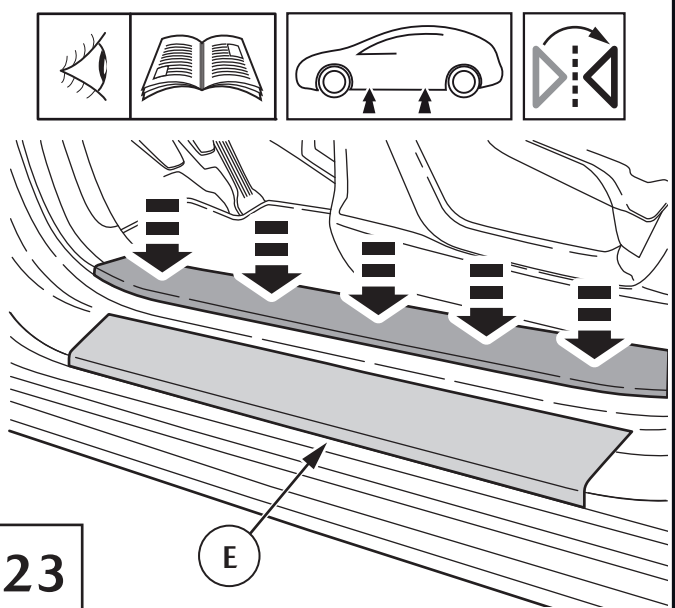

23

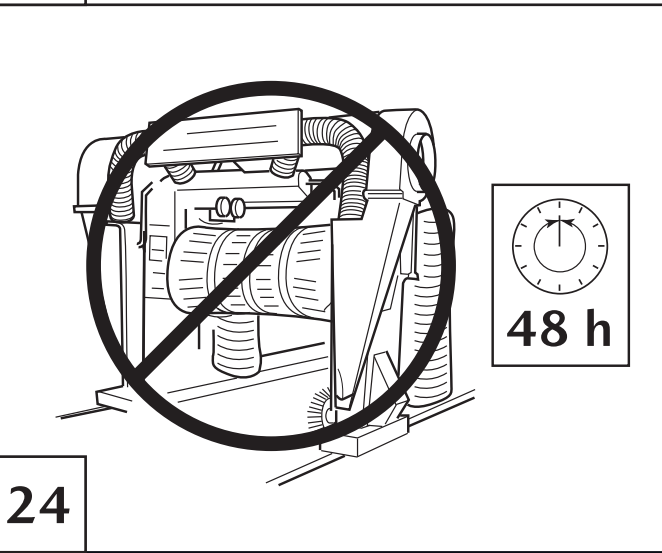

24

Subject to alternation without notice
 Technische Änderungen vorbehalten
 Reservadas modificaciones técnicas
 Sous réserve de modifications techniques
 Con riserva di apportare modifiche tecniche
 Reservamo-nos o direito a alterações técnicas
 Technische wijzigingen voorbehouden
 Med forbehold for tekniske ændringer
 Tekniske forendringer forbeholdes
 Med reservation för tekniska ändringar
 Tekniset muutokset pidätetään
 Technické zmeny vyhradeny
 A változtatások technika jogát fenntartjuk
 Zmiany techniczne zastrzeżone
 Επιφύλασσόμεθα για αλλαγές
 Можно изменять без уведомления
 Technické zmeny vyhradené