

Portable Speakers

iNSPIRE iP12B

1,000 Watt Powered 12" Subwoofer with Dual Amplifiers for Satellite Speakers, KLARK TEKNIK Spatial Sound Technology, Digital Mixer, Remote Control via iPhone/iPad and Bluetooth Audio Streaming



- Powered 12" subwoofer for portable PA applications and high quality music playback
- KLARK TEKNIK's revolutionary SST (Spatial Sound Technology) for creating 3D acoustic environments
- 1,000 Watt power, multi-channel KLARK TEKNIK Class-D technology
- 600 Watt high excursion 12" subwoofer for low distortion sub-bass response
- Dual 200 Watt amplifiers included for stereo satellite speakers
- 3 channel digital mixer with gain setting recall
- Comprehensive remote control via Apple iPhone/iPad*
- High quality Bluetooth* stereo audio streaming
- DSP presets for application type and speaker positioning
- Intuitive single rotary control user interface with LCD display for ease of navigation
- Road worthy birch plywood enclosure with hard wearing semi matt black paint finish
- Integrated protective perforated steel mesh grille
- Integral ergonomic carrying handles for ease of portability
- 35 mm pole mount to support satellite speaker
- 3-Year Warranty Program*
- Designed and engineered in the U.K.

The 1,000-Watt iNSPIRE iP12B powered subwoofer produces high levels of low-end punch, with the definition and clarity typically reserved for much larger systems. Equipped with a dedicated 600-Watt Class-D amplifier for the 12" long-excursion Low-Frequency (LF) driver, and 2 x 200-Watt amps for your passive satellite speakers, the iP12B is ideally-suited for small to medium-sized performance venues, houses of worship, boardroom presentations, nightclubs, and much more. Lightweight (only 22.3 kg / 49.2 lbs) and easy to transport, the iP12B also features a 3-channel digital mixer with industry-leading KLARK TEKNIK Digital Sound Processing (DSP), Class-D amplifier and Spatial Sound technologies – plus convenient Bluetooth stereo audio streaming and iPhone/iPad remote control. Put simply, this cool-running system delivers amazingly-deep, chest-pounding bass that will keep the party going all night long.



*Apple, iPhone and iPad are trademarks of Apple Inc. The Bluetooth word mark and logos are registered trademarks owned by Bluetooth SIG, Inc. and any use of such marks is under license. All third-party trademarks are the property of their respective owners. Their use neither constitutes a claim of the trademark nor affiliation of the trademark owners with MUSIC Group. Product names are mentioned solely as a reference for compatibility, effects and/or components. Warranty details can be found at music-group.com.

Portable Speakers

iNSPIRE iP12B

1,000 Watt Powered 12" Subwoofer with Dual Amplifiers for Satellite Speakers, KLARK TEKNIK Spatial Sound Technology, Digital Mixer, Remote Control via iPhone/iPad and Bluetooth Audio Streaming

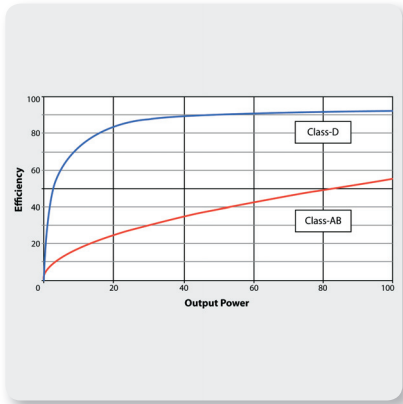

Tiny Subwoofer – Tremendous Sound

Designed for maximum portability and low-end support, the iP12B can be used as a standalone subwoofer with your powered full range speakers, or the backbone of a great-sounding speaker system. Setup is fast and easy; just connect your mic or mixer feed, your passive loudspeakers, and power. The iP12B instantly fills the room with the world-famous **TURBOSOUND** “sound” that has won the coveted Queen’s Award – an unprecedented three times.

KLARK TEKNIK – Inspired Technology

KLARK TEKNIK is recognised worldwide as one of the most prestigious British audio companies, with a 40-year pedigree and even a TEC Lifetime Achievement Award to back it up. The Company has designed and manufactured products for world-class artists, and their legendary **DN780** reverb processor is considered by leading audio engineers around the world as the industry standard. Check out their website to learn more about **KLARK TEKNIK**’s legendary heritage.

TURBOSOUND is proud to incorporate custom-engineered **KLARK TEKNIK** Class-D amplifier and DSP technologies into their products.

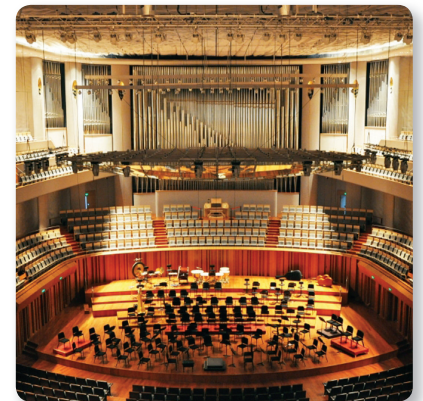

DSP – the Secret to Superb Sound

From the instant your signal enters the iP12B, the built-in DSP takes over ensuring the highest possible signal integrity. Much more than just selective EQ enhancement, the 24-bit processor analyses the incoming signal and intelligently applies specific filters to actually improve the sound quality. It’s like having an audio engineer monitoring the input and output signals, dialing in the perfect EQ and constantly making subtle adjustments to the crossover, compressor/limiter, three discrete amplifier channels and more – all of which adds up to significantly better sound.

Portable Speakers

iNSPIRE iP12B

1,000 Watt Powered 12" Subwoofer with Dual Amplifiers for Satellite Speakers, KLARK TEKNIK Spatial Sound Technology, Digital Mixer, Remote Control via iPhone/iPad and Bluetooth Audio Streaming

Custom-Engineered Drivers

Our speakers are designed specifically for each application – it's what sets us apart from the competition. When you buy a **TURBOSOUND** speaker system, you can rest assured that the speakers inside have been engineered to perform flawlessly in conjunction with every other element for truly professional results.

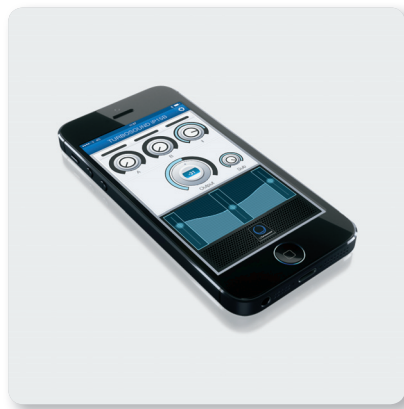

Built-in Digital Mixer – Comprehensive Remote Control

The iP12B features a fully addressable onboard digital mixer with two combo jack/XLR connectors that accept balanced and unbalanced connections for dynamic mics and line-level instruments. The simple and intuitive user interface consists of a single rotary push-encoder with Process, Setup, Exit and Enter function buttons. A beautifully-backlit LCD panel displays parameters for Delay (up to 300 ms), Limiter, High/Low shelving and parametric EQs, and Presets. All settings can be controlled locally, or via free downloadable iPhone/iPad apps – and locked down to prevent unauthorised access.

We take Bluetooth a step further, giving you total control of the iP12B directly from your iPhone or iPad. This amazing feature lets you adjust all settings from either the listening area or the stage, for the perfect sound every time. The dedicated apps are available free of charge at turbosound.com, or from the Apple App Store.

Bluetooth Ready

The days of tape decks, CD and even mp3 players are long gone. Now your music lives on your smartphone or computer tablet, so you can stop searching for those outdated cables and fancy adapters. An industry first, the iP12B puts all your music at your fingertips via stereo Bluetooth. Now with a simple wave of your hand, you can stream music from any Bluetooth-equipped iOS device, such as your iPad, iPod touch, iPhone – or even your laptop computer.

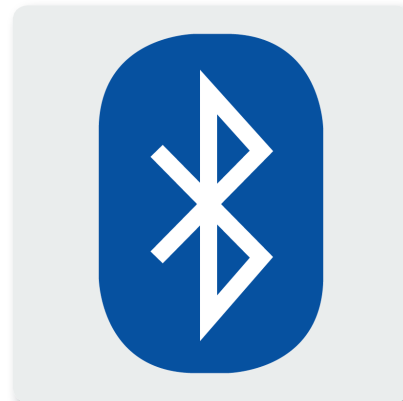

Portable Speakers

iNSPIRE iP12B

1,000 Watt Powered 12" Subwoofer with Dual Amplifiers for Satellite Speakers, KLARK TEKNIK Spatial Sound Technology, Digital Mixer, Remote Control via iPhone/iPad and Bluetooth Audio Streaming



Stunning Performance – Superb Value

The iNSPIRE iP12B powered subwoofer stands head and shoulders above the rest of the pack and delivers exceptional performance, even when pushed to the limit. Ultra-lightweight and powerful with a custom-designed 12" long-excursion LF driver, an integrated mixer, stereo Bluetooth streaming, iPhone/iPad remote control, 1,000 Watts of KLARK TEKNIK's Class-D output power and Digital Sound Processing, the iP12B is ideal for both portable and installed applications – at a price unheard of in this class.

Experience the iP12B at your local dealer today, or get yours online today – and let TURBOSOUND take your performance to the next level!

You Are Covered

We always strive to provide the best possible Customer Experience. Our products are made in our own MUSIC Group factory using state-of-the-art automation, enhanced production workflows and quality assurance labs with the most sophisticated test equipment available in the world. As a result, we have one of the lowest product failure rates in the industry, and we confidently back it up with a generous 3-Year Warranty program.



Portable Speakers

iNSPIRE

iP12B

1,000 Watt Powered 12" Subwoofer with Dual Amplifiers for Satellite Speakers, KLARK TEKNIK Spatial Sound Technology, Digital Mixer, Remote Control via iPhone/iPad and Bluetooth Audio Streaming

Frequency Response Sensitivity 1 W / 1 m

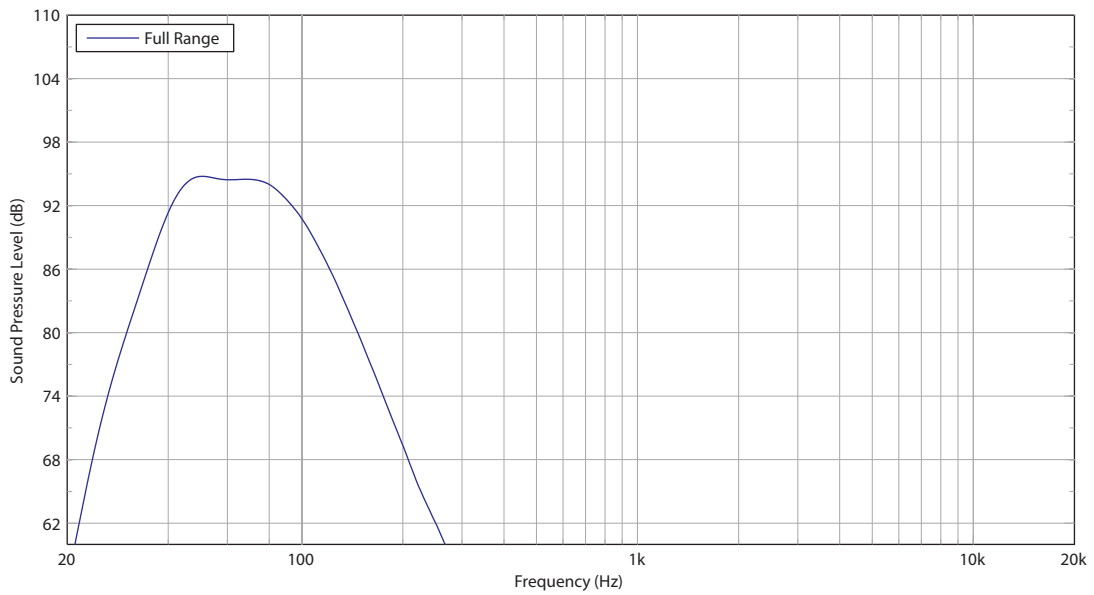

Portable Speakers

iNSPIRE

iP12B

1,000 Watt Powered 12" Subwoofer with Dual Amplifiers for Satellite Speakers, KLARK TEKNIK Spatial Sound Technology, Digital Mixer, Remote Control via iPhone/iPad and Bluetooth Audio Streaming

Dimensions

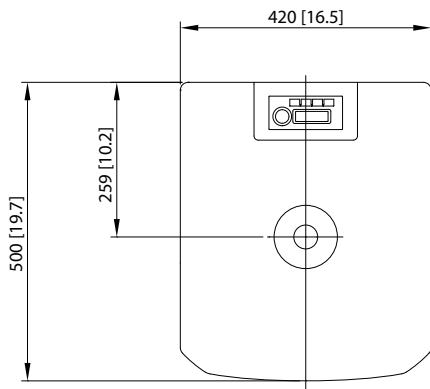

TOP

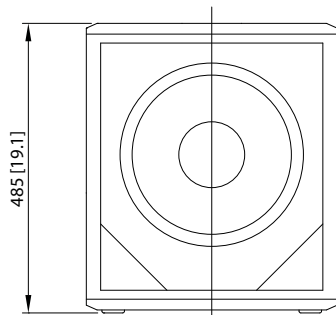

CL
FRONT

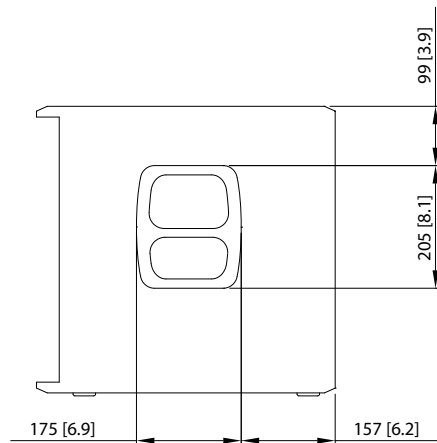

SIDE

Portable Speakers

iNSPIRE iP12B

1,000 Watt Powered 12" Subwoofer with Dual Amplifiers for Satellite Speakers, KLARK TEKNIK Spatial Sound Technology, Digital Mixer, Remote Control via iPhone/iPad and Bluetooth Audio Streaming

Technical Specifications

System

Frequency response	45 Hz – 150 Hz \pm 3 dB 38 Hz – 200 Hz -10 dB
Nominal dispersion	Half space
Maximum SPL	120 dB
Crossover type	Active
Transducers	1 x 12" (305 mm) LF driver
Limiter	Peak and RMS

Amplifier

Maximum output power*	
Subwoofer	600 W
Satellites	2 x 200 W
Type	Class-D
Protection	Short circuit, open circuit, thermal

Connectors

Output L / R	2 x Neutrik speakON* NL4, pins 1+ / 1-
Input A / B	2 x combo jack / XLR
Sensitivity	4 dBu, nominal
Input impedance	16 k Ω unbalanced, 33 k Ω balanced
Maximum input level	+22 dBu
Link output	XLR
Mains supply	IEC mains connector with integrated power switch

Controls

Hardware	Rotary push-encoder
Software	iOS interface via Bluetooth

User DSP Functions

Factory EQ presets	Positioning, Sound mode, phase
Display	LCD 128 x 32, blue, backlit
Equalisation	Bass, middle and treble
Crossover	High pass L-R 24 dB/oct
Protection	Lock-out function for all settings

Bluetooth Wireless Technology

Frequency range	2402 MHz ~ 2480 MHz
Channel number	79
Version	Bluetooth 4.0 dual mode
Output	8 dBm
Compatibility	Supports A2DP 1.2 profile
Maximum communication range	30 m (without interference)
Connectivity	Master-slave: stereo pairing link

Power Supply

Power consumption	110 W @ 1/8 max power
Voltage (fuses)	
USA / Canada / Japan	100-120 V~, 50/60 Hz (T 6.3 A H 250 V)
UK / Australia / Europe	220-240 V~, 50/60 Hz (T 3.15 A H 250 V)
Korea / China	220-240 V~, 50/60 Hz (T 3.15 A H 250 V)

Portable Speakers

iNSPIRE iP12B

1,000 Watt Powered 12" Subwoofer with
Dual Amplifiers for Satellite Speakers,
KLARK TEKNIK Spatial Sound Technology,
Digital Mixer, Remote Control via iPhone/iPad
and Bluetooth Audio Streaming

Enclosure

Dimensions (H x W x D)	485 x 420 x 500 mm (19.1 x 16.5 x 19.7")
Net weight	22.3 kg (49.2 lbs)
Construction	15 mm (5/8") birch plywood sub
Finish	Semi matt black paint
Grille	Powder coated perforated steel

Portable Speakers

iNSPIRE

iP12B

1,000 Watt Powered 12" Subwoofer with Dual Amplifiers for Satellite Speakers, KLARK TEKNIK Spatial Sound Technology, Digital Mixer, Remote Control via iPhone/iPad and Bluetooth Audio Streaming



Portable Speakers

iNSPIRE

iP12B

1,000 Watt Powered 12" Subwoofer with
Dual Amplifiers for Satellite Speakers,
KLARK TEKNIK Spatial Sound Technology,
Digital Mixer, Remote Control via iPhone/iPad
and Bluetooth Audio Streaming



Portable Speakers

iNSPIRE iP12B

1,000 Watt Powered 12" Subwoofer with
Dual Amplifiers for Satellite Speakers,
KLARK TEKNIK Spatial Sound Technology,
Digital Mixer, Remote Control via iPhone/iPad
and Bluetooth Audio Streaming



Portable Speakers

iNSPIRE iP12B

1,000 Watt Powered 12" Subwoofer with
Dual Amplifiers for Satellite Speakers,
KLARK TEKNIK Spatial Sound Technology,
Digital Mixer, Remote Control via iPhone/iPad
and Bluetooth Audio Streaming



For service, support or more information contact the TURBOSOUND location nearest you:

Europe
MUSIC Group Services UK
Tel: +44 156 273 2290
Email: CARE@music-group.com

USA/Canada
MUSIC Group Services NV Inc.
Tel: +1 702 800 8290
Email: CARE@music-group.com

Japan
MUSIC Group Services JP K.K.
Tel: +81 3 6231 0454
Email: CARE@music-group.com

MUSIC Group accepts no liability for any loss which may be suffered by any person who relies either wholly or in part upon any description, photograph, or statement contained herein. Technical specifications, appearances and other information are subject to change without notice. All trademarks are the property of their respective owners. MIDAS, KLARK TEKNIK, LAB GRUPPEN, LAKE, TANNÖY, TURBOSOUND, TC ELECTRONIC, TC HELICON, BEHRINGER, BUGERA and DDA are trademarks or registered trademarks of MUSIC Group IP Ltd.
© MUSIC Group IP Ltd. 2017 All rights reserved.

