



User Manual

CATLINK AI Cat Litter Box – Scooper Pro – X

Shanghai Catlink Intelligent Technology Co., Ltd

【Contents】

【Unpacking Operation】	1
【Packing List】	3
【Product Structure】	4
【Function Differences】	5
【Working Mode】	6
【Protection Mechanism】	7
【Control Panel & Button Operation】	8
【Indicator Conditions】	10
【Wi-Fi Connection】	12
【Cat Litter Replacement】	15
【Product Cleaning and Attentions】	16
【Exception Dealing】	18
【Product Specifications & CATLINK Features】	20
【After-sale Service】	25
【Service Card】	26

【 Unpacking Operation】

- 1 Check whether the items are complete according to the 【Packing List】 (Page 3).
- 2 Place the product properly according to the 【Product structure】 (Page 4) .
- 3 Insert the power adapter into the power port at the back of the product.
-----please refer to picture 3.1
- 4 Check whether the waste bag is properly inserted, and properly push the waste box back to its original position.-----please refer to picture 4.1

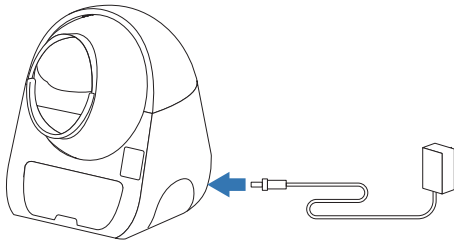

【Picture 3.1】

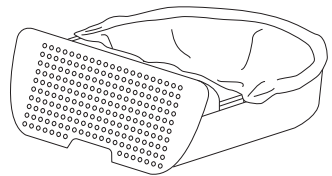

【Picture 4.1】

- 5 Use environment check:
 - 1) Make sure that the device is placed on a flat and solid ground with no other object at the bottom.-----please refer to picture 5.1
 - 2) Make sure that the device is not dependent on any object around, and there is no other objects are placed on the top.-----please

3) Make sure that the device is close to the Wi-Fi signal and far away from electrical appliances with strong interference.-----please refer to picture 5.3

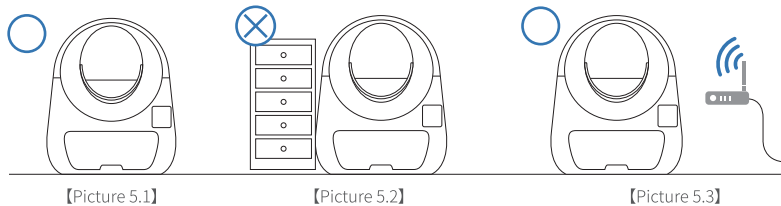

6 Self-check operation:

Power on is to start, and enter the self-test state. After the self-check is completed, it can proceed to the next step.

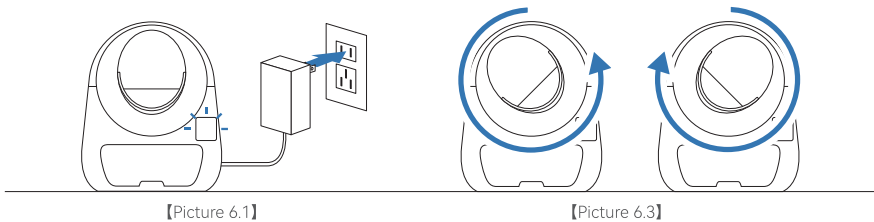

- 7 Download the CATLINK APP and refer to **【Wi-Fi Connection】** (Page12) for network connection.
- 8 Add enough cat litter to the ball cabin, paying attention to be below the Max line. After adding the cat litter, pls press(▶) to clean-up once for paving the cat litter.

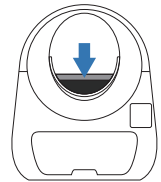
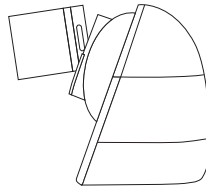

Note: Pro version is suitable for bentonite cat litter, mixed cat litter (bentonite & tofu litter).-
Standard/Luxury/Young version is suitable for bentonite cat litter only.

- 9 The litter box can be used normally when the above steps are completed.

【Packing List】

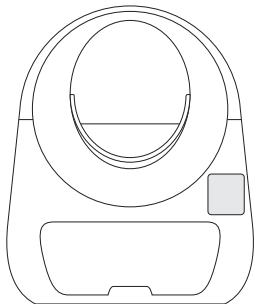

CATLINK
AI litter Box

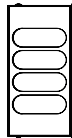

Carbon Filter Box

The carbon filter box has been placed in the waste box. CATLINK recommends taking this part out every month and exposing it to the sun, and replacing it every 2 months.

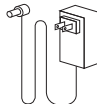

Power
Adapter

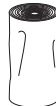

Roll
of Garbage Bags



User Manual
(Service Card included)

【Product Structure】

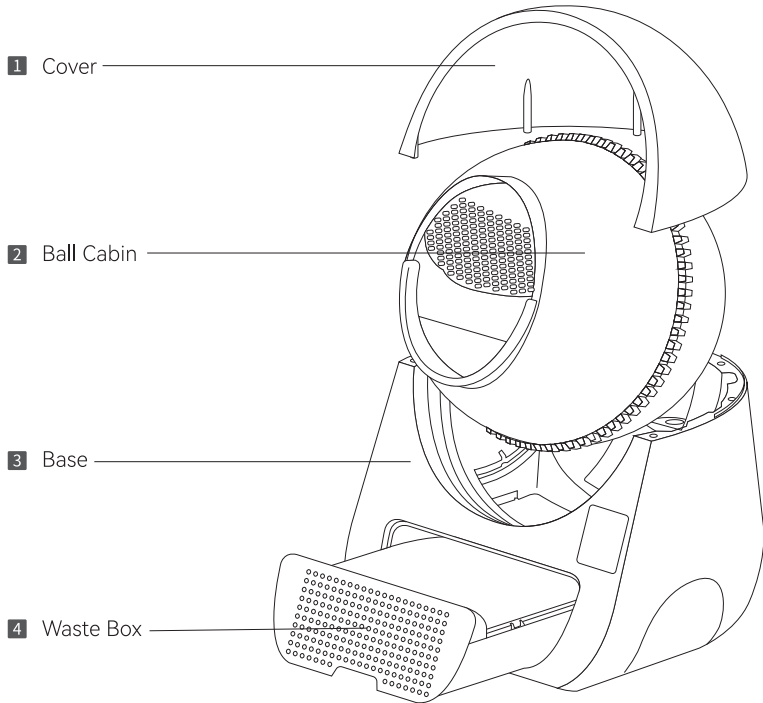

【Function Differences】





Function	Standard Pro - X	Luxury Pro - X
Ambient light	×	✓
Temperature & humidity sensing	×	✓
Cat litter volume monitoring	×	✓
Protection from weighing sensors	✓	✓
Anti-pinch protection	✓	✓
Radar protection	✓	✓
UV sterilization	✓	✓
Deodorant function	✓	✓
Voice prompts	✓	✓

Note:

Deodorant function: This function is enabled by default, and the optimal method has been selected by default. Other settings are not supported for the time being.

Voice prompts: Voice prompts are only available in mainland China.

【Working Mode】

Mode	Icon of App &Control panel	Operation method	Notifications
Auto mode		Operation through APP &Control panel button	Timer starts when the cat leaves the ball cabin. After 5 minutes by default, the cat litter box will be automatically cleaned once. Note: This default time can be set in the APP
Manual Mode			In this mode, you can start or pause the filter cat litter by manual
Timer Mode			In this mode, you can set a time to start cleaning automatically (Wi-Fi connection only)
Empty Mode			While the cat litter changes, empty the cat litter in the ball cabin.

【Protection Mechanism】

Protective function	Priority level	Notifications
Radar protection *Only supported by Pro version	1st	During the rotation of the ball cabin, if a moving object enters the ball cabin, the radar protection will be triggered first, and the ball cabin will stop rotating. When the object is detected to leave, the ball cabin will resume rotation. Note: Due to technical limitations, this protection is temporarily disabled during the self-checking process.
Protection from weighing	2nd	During the rotation of the ball cabin, if an object larger than 1.5kg enters the ball cabin, the weighing protection will be triggered, and the ball cabin will stop rotating. When the object is detected to leave, the ball cabin will resume rotation.
Anti-pinch protection	3rd	When the ball cabin's litter outlet is facing downwards and the anti-pinch device is started during rotation, the ball cabin will release the maximum litter outlet space and stop running. This protection can only be lifted after human intervention.
Anti-blocking protection	4th	The ball cabin will stop rotating when the motor resistance suddenly increases during the rotation of the ball cabin. This protection can only be cancelled with human intervention.

【Control Panel】

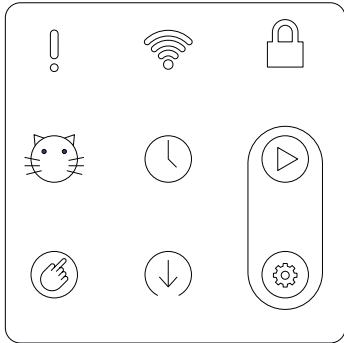

Error
indicator

Wi-Fi
indicator

Panel lock
indicator

Auto mode
indicator

Timer Mode
indicator

Clean/Pause
button

Manual Mode
indicator

Empty Mode
indicator

Mode
button

【Button Operation】

1 Mode button



The mode will be switched in order from Auto, Manual, Timer, Empty in a cyclic manner each time you press the button.

Note: The timer mode only works with Wi-Fi connection.

2 Clean/Pause button



Press the button to start or stop the operation.

3 Panel locking button



Press and hold the Mode button and the Clean/Pause button for three seconds.  + 

Release the buttons when you hear a beep. If the Panel lock indicator is on, the panel locking is successfully enabled. If you want to disable the panel locking, repeat the above-mentioned operations. If the Panel lock indicator is off, the panel locking is successfully disabled.

Note: This Function can also be turned on or off on CATLINK APP.

4 Wi-Fi connection button











Press and hold the Mode button and the Clean/Pause button.  + 

Release the button when you hear the second beeping sound. If the Wi-Fi connection indicator blinks, the device is ready for network configuration.

If the Wi-Fi connection is instantly on after you release the buttons, the network configuration has been completed and the device is already connected to the network. In this case, you can skip the network configuration and proceed to the next step.

【Indicator Conditions】

Indicator		Lighting conditions	Notifications
Auto mode indicator		Constantly on	The device is in the Auto mode. The device is available for cat to use.
Manual Mode indicator		Constantly on	The device is in the Manual mode. The device is available for a cat to use and needs to be manually operated.
Timer Mode indicator		Constantly on	The device is in the Timer mode. The device is available for a cat to use and will operated automatically at the set time.
Empty Mode indicator		Constantly on	The device is in the Empty mode. The device is operating and not available for a cat to use until the emptying is complete.
Error indicator		Constantly on	During weighing, the device is suspended.
		Fast flashing	During radar protection, the device is suspended.
		Slow flashing	Full waste box.

Indicator		Lighting conditions	Notifications
Error indicator+ Panel lock indicator	 + 	Fast flashing	During anti-pinch protection
		Slow flashing	During anti-blocking protection
Wi-Fi indicator		Lights off	Not connected
		Constantly on	Wi-Fi connection
		Flashing	Connecting
Panel lock indicator		Lights off	Not locked
		Constantly on	Locked

After the machine is powered on, certain lights on the control panel will always be on. If all lights are off, contact professional after-sales personnel for detection and treatment.

【Wi-Fi Connection】

- 1 Download the CATLINK in the application market of your phone after the self-checking (lasting for 2 minutes) is ended.



- 2 Connect your phone to 2.4GHz WiFi, it does not currently support 5GHz and WiFi that requires special certification.

Note: Name of WiFi cannot contain Chinese, spaces, or special characters, so as not to affect the WiFi connection.

- 3 Open the CATLINK to register and log in. Find and click "Add Device" -> "AI Litter Box" and follow the instructions.

*Please authorize location information. Android need to turn on GPS.

- 4 Press and hold the Mode button and the Clean/Pause button at the same time until you hear the second beeping sound. Then, the Wi-Fi connection indicator will blink, showing the device is ready for network configuration. Use CATLINK to configure the network.

*Please keep the AI litter box as close as possible to the router.

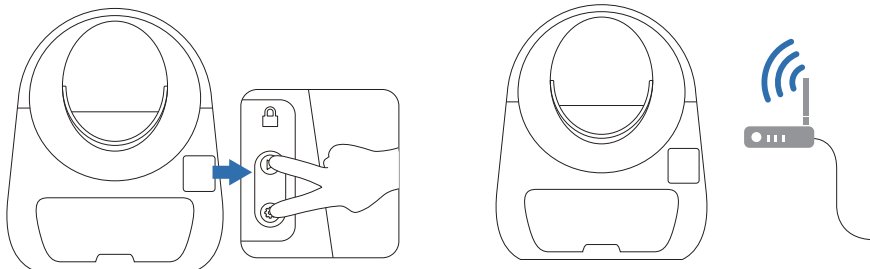

- 5 Operate according to the instructions on the CATLINK-----please refer to picture 7.1
 "If the Wi-Fi connection indicator is constantly on, the device already has Wi-Fi connection and can be controlled from the APP."
 *If there is a network connection failure, please patiently re-operate it again, and pay attention to check whether the WiFi password is correct. There may be a problem of poor network connection for some Android users. If possible, please use other phones for network connection. After the network is successfully connection, log in to the CATLINK on your original phone and you can use it normally."
 "In the case of multiple confirmations that your operation is correct, but the network connection still fails, please contact after-sales assistance in time."
- 6 After the connection is successful, the WiFi indicator of the device keeps constantly on.
 -----please refer to picture 8.1
- 7 After completing the above steps, the functions of CATLINK can be used normally.

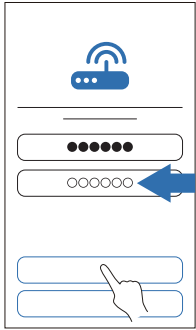

【Picture 7.1】

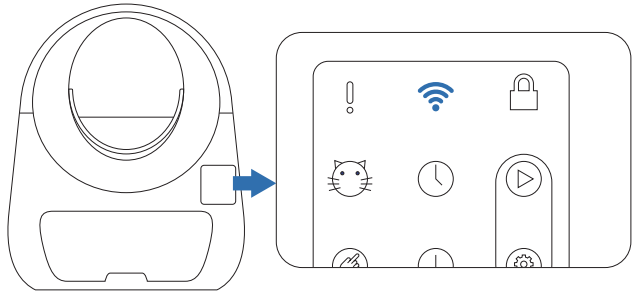

【Picture 8.1】

【Cat litter Replacement】

- 1 Short press the Mode button once until it switches to the empty mode

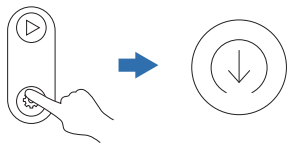

- 2 The ball cabin starts to rotate clockwise when a single short press of the Clean/Pause button

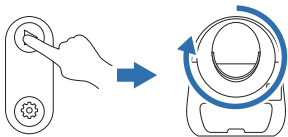

- 3 Wait until the litter outlet of the ball compartment is vertically downward, and all cat litter falls into the garbage compartment, the start/pause button light flashes, short press the start/pause button again to reset

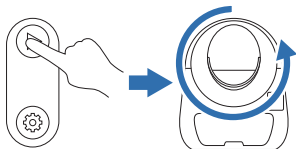

- 4 After the ball cabin is reset, take out the waste box, seal and discard the waste cat litter, put on a new waste bag, and push the waste box back to its original position

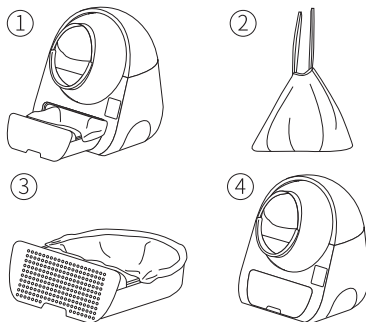

- 5 Add enough cat litter to the ball compartment, below the Max scale line, after adding sand, press the start/pause button to clean up once for paving the cat litter.

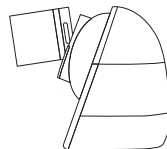

【Product Cleaning and Attentions】

- 1 Refer to the steps of **【Cat Litter Replacement】** (Page 15) , and power off after the cat litter is empty

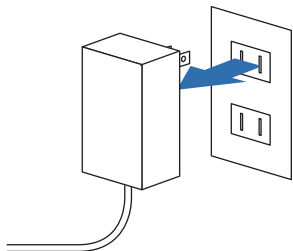

- 2 Remove the top cover. If it is a luxury version, please remove the connecting wire as shown in the figure before removing the top cover.

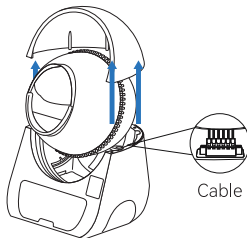

- 3 Take out the ball cabin (pay attention to remove the supporting rod of the rotating shaft on the back of the ball cabin)

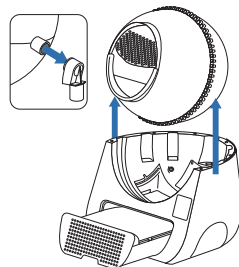

- 4 Take out the waste box and the cotton filter (The cotton filter is recommended to expose to the sunshine once a month and replace it once every two months)

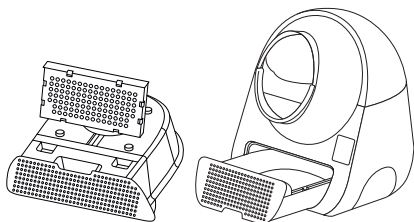

- 5 Parts can be washed directly (be sure to wipe and dry thoroughly after washing)

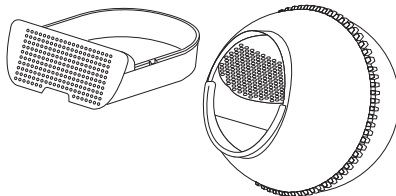

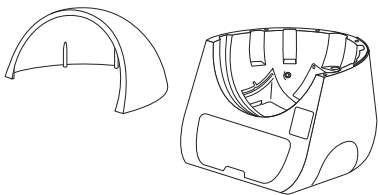

- 6 Parts can be wiped with wet wipes (contains electronic parts and cannot be washed directly)



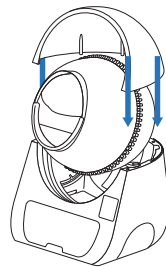
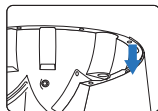
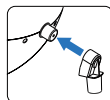

- 7 After cleaning, put the new filter cotton box back into the garbage bin, and assemble the other components in the reverse steps, and then the product can be used normally.

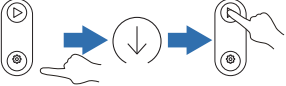
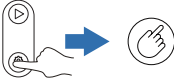
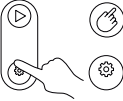
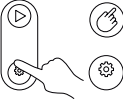

【Exception Dealing】

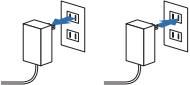
Exceptions	Operation method	Operation steps
The device stops running due to abnormal radar/weighing protection or full waste box	Cancel by manual	Press the Clean/Pause button once 
The device stops running due to the anti-pinch function being triggered	Cancel by manual	Press the Clean/Pause button once 
Inaccurate cat litter volume (The situation that the sensor in the cover is covered by dust has been excluded)	The volume of cat litter is reset to zero	1 Empty the cat litter 
		2 Switch to manual mode 
		3 Long press the Mode button, release it after hearing two beeps, the Manual mode indicator and the Mode button indicator will flash 
		4 Press the Mode button immediately, and release it after hearing two beeps again 
		5 The operation is complete

Exceptions	Operation method	Operation steps
<p>Inaccurate weighing data(Inaccuracies caused by the use environment have been excluded)</p>	<p>Adjust the weighing</p>	<p>1 To prepare reference objects, you can use 1.5kg items, 1.5L mineral water or 3 bottles of 500ml mineral water</p>
		<p>2 Power off and restart the device</p> 
		<p>3 Put a 1.5kg object into the ball cabin after rotating the ball cabin, press and hold the Mode button, release it after hearing two beeps, the Mode button indicator will flash</p> 
		<p>4 After the Mode button indicator light is constantly on and a beep is heard, the weighing is completed</p> 

【Product Specifications】

Name	CATLINK AI Cat Litter Box (Pro - X) - SCOOPER
Product Model	CL-07/CL-08
Primary material	PP
Size	600x580x710mm
Rated voltage	12V 
Rated power	5W
General Scope	Cat (1.5-10 kg)
Weight	11kg
Carried standard	GB 4706.1-2005

[The specifications of different models or batches of products may vary.](#)

Regional Restriction Policy:

In order to ensure the rights and interests of overseas users and overseas exclusive agents, products that have not been purchased through official certification channels may not be able to connect to the Internet. Please be sure to purchase

CATLINK products through official channels.

【CATLINK Features】

1 【Health Ecosystem】

The device has function of multi-cat recognition, and the health report of each cat can be viewed in the Catlink App.

Version: CATLINK AI Litter Box-Scooper(Luxury/ Standard/ Luxury Pro/ Standard Pro)

CATLINK AI Feeder-ONE-Standard(Multiple Pets)

CATLINK AI Water Fountain-PURE

Note: The Catlink AI Litter Box-Young does not have this function (It is not connected to the Internet)

2 【CATLINK equipment sharing】

The main account can share unlimited permissions to family members and friends, and they can control the device or view health reports through the APP.

3 【CATLINK unlimited numbers of cat】

A single device can be associated with multiple cats without limitation.

The cat's customized health report will summarize the related data received on all of the cat's devices.

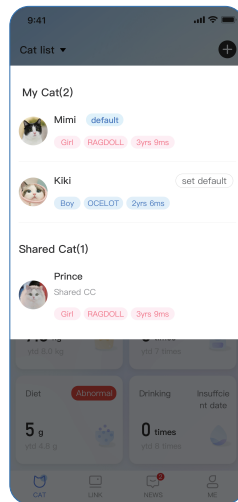
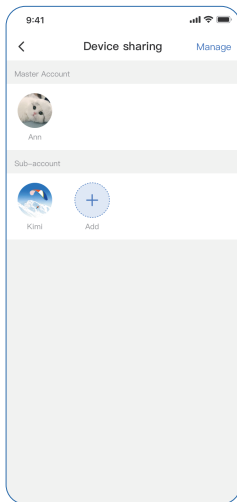

4 【CATLINK protection function】

In order to guarantee the rights and interests of overseas users and overseas exclusive agents, products that have not been purchased through official certification may not be connected overseas. Please be sure to purchase our products through formal form.

Catlink AI Litter Box-Scooper Pro

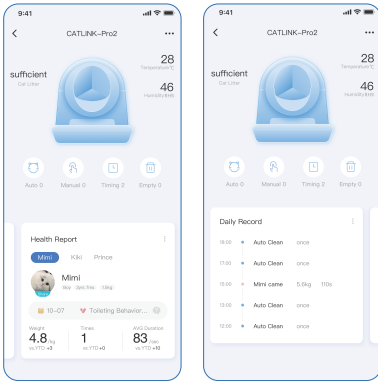

Health report on excretion

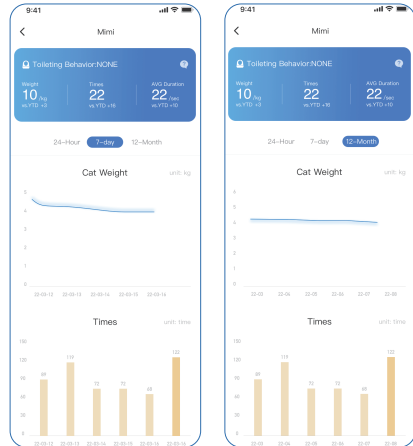

CATLINK AI Feeder-ONE-Standard(Multiple Pets)

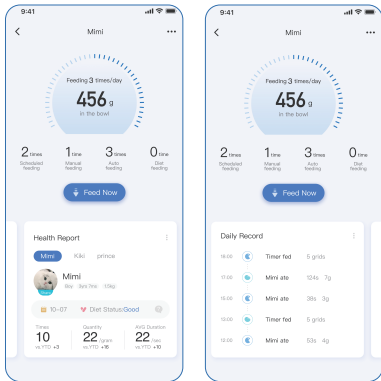

Health report on diet

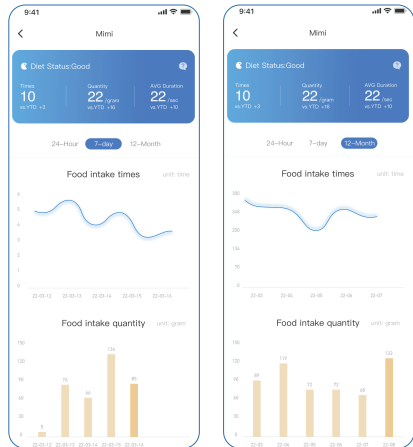

Catlink AI Water Fountain-PURE

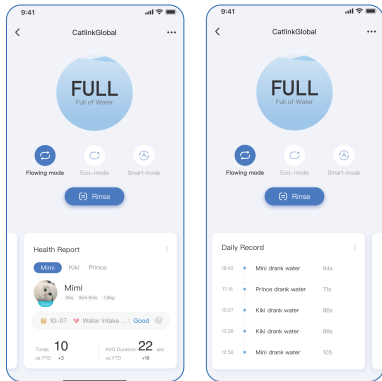

Health report on drinking

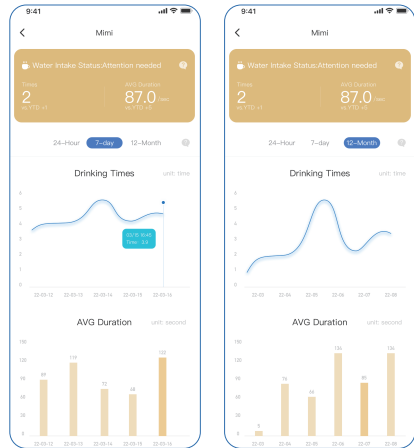

The CATLINK APP page will be updated from time to time. The actual report page may be different from the above picture. The above picture is for reference only.

【After-sale Service】

According to China's national regulations, we will provide customers with a one-year free warranty service.

After-sales service contact information in Mainland China

1.Customer service of your CATLINK

2.Tel Number of after-sale:(+0086)18117545826、(+0086)18121136180

3.Mailbox of after-sale:customer@catlink.cn、 support@catlink.cn

*For after-sales service in other regions, please contact your local dealer.



【Service Card】

Dear CATLINK user, thanks for using CATLINK series products, please read the following warranty clauses carefully before using this product.

1. The warranty period of this product is: within one year from the date shown on the valid purchase certificate.
2. During the one-year warranty period, our company will provide free warranty service for failures caused by the quality of the product when the user uses the product normally.
3. The following conditions are not covered by the warranty service:
 - (1) Wrong installation, use and malicious destruction;
 - (2) Unauthorized disassembly and repair;
 - (3) Failure caused by the use of other accessories;
 - (4) Use in a hostile environment;

 - (5) Exceeding the promised warranty period;
 - (6) No valid certificate of purchase;
 - (7) Equipment failure caused by irresistible external events.
4. You can communicate with the after-sales specialist to confirm whether you are entitled to free warranty service.
5. When you send the product back, please complete the form on this page and send this form together with the product.

【Service Card】

Name of user	
Tel of user	
Address of user	
Name of product	
Purchase date	
The way of buying	
Problem Description	



Shanghai Catlink Intelligent Technology Co., Ltd

Company address: No.800 Naxian road, Pudong new district, Shanghai, China

Company number: (+0086)021-50686520

Company mailbox: business@catlink.cn

Company website: www.catlink.cn