

Preparation:- For Best Results Fix Brackets within 300mm Either Side of Join

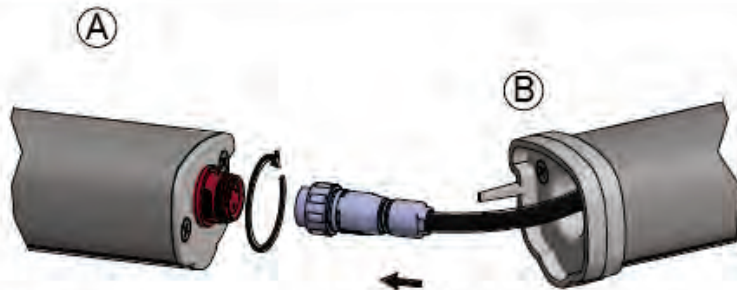

Plug Male & Female Connector Together & Twist to Seal

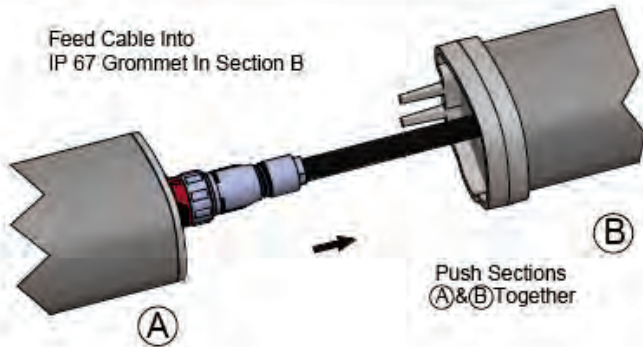

Feed Cable Into IP 67 Grommet In Section B

Push Sections A & B Together

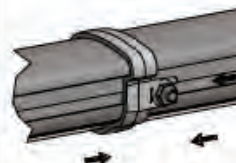

Bolt At Rear Into Slotted Prong

1. IMPORTANT: Please read these instructions carefully before proceeding with installation.
- 1.1 This instruction sheet should be passed on by installer to the end user for maintenance purposes.
- 1.2 It is recommended that the fitting is installed by a competent electrician in accordance with these instructions and appropriate wiring regulations.
- 1.3 iO sign supply products should not be modified. No responsibility will be accepted for any modified products or for any damage caused as a result of their modification.
- 1.4 It is not recommended to install the fitting in areas that are liable to reach an ambient temperature in excess of 35 °C.
- 1.5 To clean fittings use a soft damp cloth and dry immediately. Do not use any chemical/abrasive cleaner.

- 1.6 All fittings are class 1 fittings and should, therefore be earthed.
- 1.7 The fitting is not suitable for dimming.
- 1.8 The fitting comes complete with an integral power supply and pre-wired with a 0.75M 3 core supply cable. The wires in this mains cable are coloured in accordance with the following code:

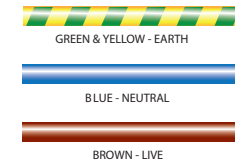

A suitable IP rated connection must be used at the other end.

- 1.9 Type Y Attachment – If the external flexible cable or cord of this luminaire is damaged, it shall be exclusively replaced by Portland Lighting Ltd or their service agent or a similar qualified person in order to avoid a hazard.
- 2 The light source contained in this luminaire shall only be replaced by the manufacturer or his service agent or a similar qualified person.



**Important Safety**

Before carrying out any servicing on this luminaire, ensure that the mains supply is fully isolated.

**technical enquiries**

If you need any help with the installation or maintenance of iO sign supply products, please contact us on +32 3 353 67 63

# Multi brackets fixing orientation Instruction

The fitting should be mounted on a suitable weight bearing surface using appropriate fixings  
(Weight per metre - Ecolux Mini 1.25kg)



Kleine Markt 7-9 b.25  
B-2000 Antwerpen  
+32 3 353 67 63  
www.io-sign.be

**H = Horizontal Fix**  
Install with H on top

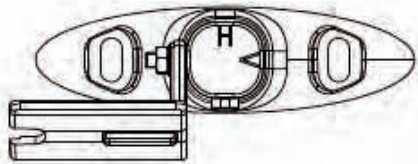

**V = Vertical Fix**  
Install with V on top

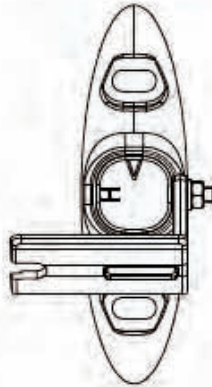

Back plate

Void

Remove cast fixing  
and slide bolt towards  
void in back plate

Rotate bracket arm slide  
bolt back into second void.  
Reassemble cast fixing

# Signlux Mini Installation...easy as 1,2,3! Secure brackets to wall then...



Kleine Markt 7-9 b.25  
B-2000 Antwerpen  
+32 3 353 67 63  
www.io-sign.be

1) Hang Ecolux Mini over  
Multi Bracket leaving hands  
free.

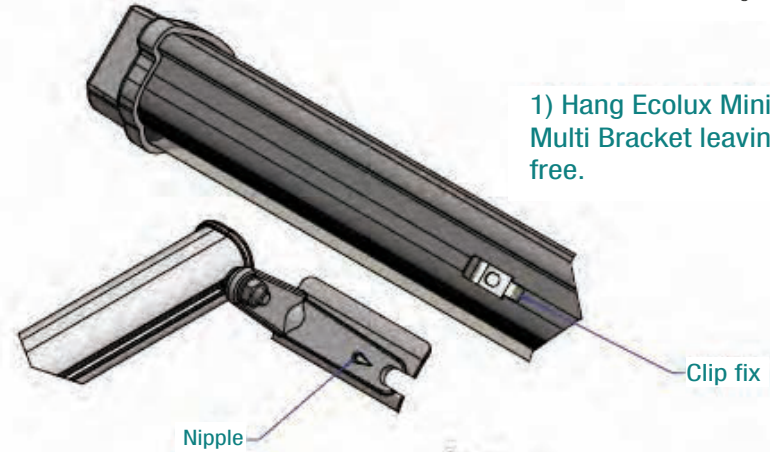

2) Slide spring clip fixing  
over nipple on casting  
to secure

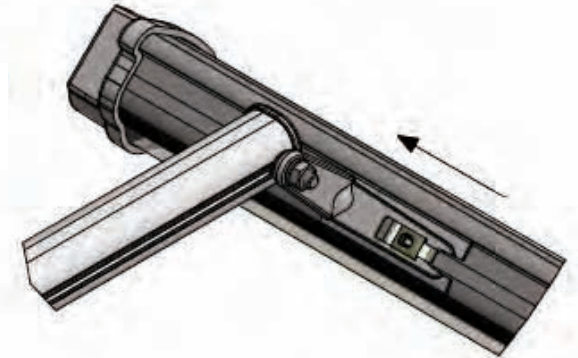

Bracket bolt

3) Secure bracket bolt. For optimum  
illumination please ensure fitting  
installed at 45° to the sign.

