

VENUS SERIES AC COUPLED ESS

MST-BIE2.5-2500//MST-BIE5-2500

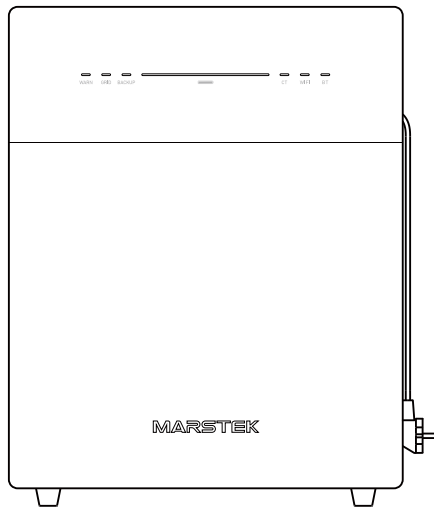

P1



P23



P45



P67



P89



P111

- Without the written permission of the Company, no unit or individual may extract, copy or disseminate the contents of this document in any form.
- It is prohibited to use part or all of the data contained in the firmware or software developed by Marstek Energy Co., Limited. for commercial purposes in any way.
- Reverse engineering, cracking or any other operation that destroys the original programming design of the software issued by Marstek Energy Co., Limited. is prohibited.

TRADEMARK NOTICE

- MARSTEK and other Marstek Energy Co., Limited. trademarks are trademarks of Marstek Energy Co., Limited. All other trademarks or registered trademarks mentioned in this document are the property of their respective owners.

NOTICE



- The products, services or features you purchase shall be subject to the commercial contract and terms of Marstek Energy Co., Limited. All or part of the products, services or features described in this document may not be within the scope of your purchase or use. Unless otherwise agreed in the contract, Marstek Energy Co., Limited. does not make any express or implied representations or warranties in this document.
- Due to product version upgrades or other reasons, the content of this document will be updated from time to time. Unless otherwise agreed, this document is only used as a guide, and all statements, information and suggestions in this document do not constitute any express or implied warranty.

FOR READERS

- This document mainly introduces the installation, electrical connection, commissioning, maintenance and troubleshooting methods of the Venus series. Please read this manual carefully before installing and using the AC COUPLED ESS, understand the safety information and be familiar with the functions and features of the AC COUPLED ESS.
- This manual is applicable to the Venus series balcony photovoltaic integrated machine. For safety reasons, all installation operations must be and are only allowed to be completed by professional technicians. Professional technicians must have relevant qualifications, receive relevant training, master relevant skills, and strictly follow the instructions contained in this manual.

SYMBOL CONVENTION

The following symbols may appear in this document and their meanings are as follows:

	Danger	This symbol indicates a dangerous situation that could cause a fatal electrocution hazard, serious personal injury, or fire.
	Warning	This symbol indicates instructions that must be followed carefully to avoid potential safety hazards.
	Careful	This symbol indicates that the operation is prohibited. The relevant personnel should stop the operation and only proceed after being fully cautious and fully understanding the operation.

MODIFICATION RECORDS

- The revision history accumulates the descriptions of each document update. The latest version of the document contains the updated contents of all previous document versions.

Document version 01 (2024.07.15) Document initial version

Content

1.	Safety Precautions	4
1.1	Personal Safety	4
1.2	Electrical Safety	5
2.	Product Introduction	7
2.1	Product Model	7
2.2	Product Description	7
2.3	Box Marking	8
2.4	Appearance Description	9
2.5	Working Mode	10
3.	Installation Instructions	11
3.1	Pre-installation inspection	11
3.2	Select Installation location	11
3.3	Installing Tools	11
3.4	Equipment Installation	12
3.5	Installation And Debugging	13
4.	Stop Debugging	15
4.1	Stop Debugging	15
4.2	Storage And Transportation	15
4.3	Disposal	15
5.	Troubleshooting	16
5.1	Troubleshooting Checklist	16
5.2	On-site Inspection	19
5.3	General Maintenance	19
5.4	Equipment Replacement	20
6.	Technical Specifications	21

1.

Safety Precautions

- The Venus series AC COUPLED ESS has been designed and tested according to international safety requirements. However, safety regulations must still be followed when installing and operating this series of AC COUPLED ESS. Installers must carefully read, fully understand and strictly comply with all instructions, precautions and warnings in this installation manual.
- It is prohibited to reverse engineer, decompile, disassemble, adapt, implant or other derivative operations on the device software, study the internal implementation logic of the device, obtain the source code of the device software, infringe intellectual property rights in any way, and disclose the results of any device software performance test.
- All operations such as transportation, storage, installation, operation, use and maintenance must comply with applicable laws, regulations, standards and specifications.
- This equipment should be used in an environment that meets the design specifications. Otherwise, the possible equipment failure, equipment malfunction or component damage is not within the scope of the equipment quality assurance. Otherwise, the company will not be liable for compensation for personal injury, property loss, etc.
- **The Company shall not be liable for any of the following circumstances or their consequences:**
 - Equipment damage caused by earthquake, flood, volcanic eruption, mudslide, lightning strike, fire, war, armed conflict, typhoon, hurricane, tornado, extreme weather, or force majeure.
 - Not operated within the conditions of use described in this manual.
 - The installation and use environment does not comply with relevant international, national or regional standards.
 - Unqualified personnel installing and using the equipment.
 - Failure to follow the operating instructions and safety warnings in the product and documentation.
 - Unauthorized disassembly, modification of the product or modification of the software code.
 - Damage caused by transportation by you or a third party you entrust.
 - Damage caused by storage conditions not meeting the requirements of product documentation.
 - The materials and tools you bring with you do not meet the requirements of local laws, regulations and relevant standards.
 - Damage caused by your or a third party's negligence, intent, gross negligence, improper operation or reasons not attributable to the Company.

1.1 Personal Safety

	It is strictly forbidden to operate with power on during the installation process. It is forbidden to install or remove cables with power on. When the cable core contacts the conductor, arcs or sparks will be generated, which may cause fire or personal injury.
	When the equipment is energized, irregular or incorrect operation may cause fire, electric shock or explosion, resulting in personal injury or property loss.
	During operation, it is strictly forbidden to wear watches, bracelets, rings, necklaces and other conductive objects to avoid electric shock and burns.



Special insulating tools must be used during the operation to avoid electric shock or short circuit failure. The insulation withstand voltage level must meet the requirements of local laws, regulations, standards and specifications.

Special protective equipment must be used during the operation, such as protective clothing, insulating shoes, goggles, safety helmets, insulating gloves, etc.

General requirements

- Do not ignore warnings, cautions, and precautions in the manual and on the equipment.
- During equipment operation, if any fault is found that may cause personal injury or equipment damage, the operation should be stopped immediately, reported to the person in charge and effective protective measures should be taken.
- Do not power on the device before the installation is completed or the device has not been confirmed by a professional.
- It is prohibited to directly touch, use other conductors to touch, or indirectly touch the power supply equipment through wet objects. Before touching any conductor surface or terminal, measure the voltage at the contact point to confirm that there is no risk of electric shock.
- When the device is running, the casing temperature is high and there is a risk of burns, so do not touch it.
- If a fire occurs, evacuate the building or equipment area immediately and press the fire alarm, or call the fire alarm. Under no circumstances is it allowed to re-enter the burning building or equipment area.

Personnel Requirements

- Personnel who operate the equipment include professionals and trained personnel.
- Personnel responsible for installing and maintaining the equipment must first undergo rigorous training, master the correct operating methods, and understand various safety precautions and relevant standards of the country/region where they are located.
- Only qualified professionals or trained personnel are allowed to install, operate and maintain the equipment.
- Only qualified professionals are allowed to remove safety features and repair equipment.
- Personnel involved in special scenarios such as electrical operations, high-altitude operations, and special equipment operations must have special operation qualifications required by the local country/region.

1.2 Electrical safety

- Before installation, please check the equipment to make sure that it has not been damaged during transportation. If damaged, the insulation integrity or safety of the equipment may be affected. Please carefully select the installation site and comply with the specified cooling requirements. Unauthorized removal of necessary protective equipment, improper use, improper installation, and improper operation may cause damage to the equipment or even cause serious safety accidents and electric shock.
- Before connecting the AC COUPLED ESS to the grid, please contact the local grid operator for approval. All connection operations stated in this manual must be completed by professional technicians who have received relevant training.

- Each input of the AC COUPLED ESS is only allowed to connect one photovoltaic module. Do not connect batteries or other power sources. If the installation environment or connected equipment does not meet the technical parameters required by the AC COUPLED ESS, please stop using the AC COUPLED ESS.
- If the on-site installation environment does not meet the standard installation conditions, please inform the manufacturer in advance.
- If the equipment needs to be repaired, please be sure to use qualified and compliant parts for repair. The relevant parts must be installed by an authorized contractor or an authorized service representative of Marstek Energy Co., Limited. and the relevant parts can only be used for their intended purpose.
- After the AC COUPLED ESS is disconnected from the public power grid, some parts of the AC COUPLED ESS may still be energized. Please be careful and beware of electric shock. Before touching the AC COUPLED ESS, please ensure that the surface temperature of the device is safe and the voltage potential of the entire device is within the safe range.
- Electrical installation and maintenance work should be completed by qualified electricians, and wiring should comply with local regulations.
- Do not operate the equipment without an installed grounding conductor.
- Do not damage the grounding conductor.
- Please check the terminal screws of the equipment regularly to make sure they are tightened and not loose.
- The grounding impedance of the equipment should meet the requirements of local electrical standards.
- The equipment should be permanently grounded. Before operating the equipment, check the electrical connection of the equipment to ensure that the equipment is reliably grounded.
- Using cables in high temperature environments may cause aging and damage of the insulation layer. The distance between the cables and the heating device or the periphery of the heat source area should be at least 30 mm.
- All cables must be securely connected, well insulated, and of appropriate specifications.
- Cable troughs and wire holes should have no sharp edges, and the cable conduits or wire holes must be protected to prevent the cables from being damaged by sharp edges, burrs, etc.
- When laying the power cord, it is strictly forbidden to make loops or twists. If the power cord is found to be insufficient, it must be replaced. It is strictly forbidden to make joints or welding points in the power cord.
- The selection, installation and routing of cables must comply with local laws, regulations and specifications.

2. Product Introduction

2.1 Product Model

Model Description

This article mainly covers the Venus-C and Venus-E product models.

Model Identification

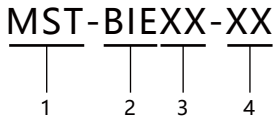

1	Company name	MST: Marstek Energy Co., Limited.
2	Series name	BIE: AC COUPLED ESS
3	Power identification	XX: 2.5 means 2.5kWH, 5 means 5kWH
4	Communication signs	XX: 2500 means 2500W

The model of the balcony photovoltaic integrated machine can be viewed on the nameplate on the back of the product.

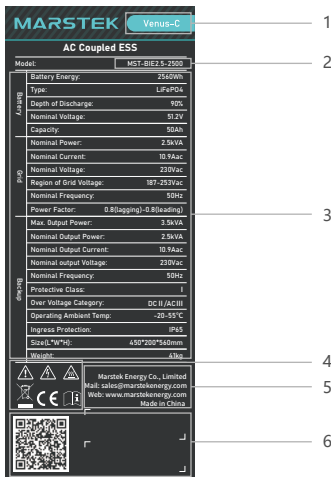

1. Product Name
2. Model identification
3. Important technical parameters
4. Certification system logo
5. Company name and place of origin
6. Barcode and QR code identification

2.2 Product Description

Function Description

AC COUPLED ESS is an AC-coupled energy storage system, which includes a power control module and a battery energy storage module. It can store and release electric energy according to the requirements of the management system. AC COUPLED ESS is an off-grid and grid-connected all-in-one machine with three working methods: anti-reverse current method, manual method and trade method. It stores electrical energy when grid power is available and supplies power to critical household devices during power outages.

Features

- It supports off-grid and grid-connected operation, with three working methods: anti-reverse current method, manual method, and trade method.
- It allows users to query the total discharge amount information of the product lifecycle in real time.
- The system is plug-and-play and supports both mobile app and integrated management system, enabling remote and local operation.
- Installation is simple and convenient by using standard installation tools.





Grid-connected Applications



The main function of the VENUS series AC COUPLED ESS is to temporarily store grid energy in the battery through a bidirectional inverter. System data is transmitted to the mobile client via a router connection.

Communication method

The VENUS series AC COUPLED ESS adopts WIFI wireless communication to meet the needs of different users, and the connection with APP is simple, fast and stable.

2.3 Box Marking

	Disposal	In order to comply with the European Directive 2002/96/EC on Waste Electrical and Electronic Equipment and other electronic equipment scrapping regulations implemented as national laws, electrical equipment that has reached the end of its service life must be collected separately and sent to approved recycling plants. If the AC COUPLED ESS is in a waste state, please be sure to return it to an authorized dealer or an approved recycling plant.
	Electric shock hazard	When the AC COUPLED ESS is working, there is high voltage. It is strictly forbidden to touch it to prevent electric shock.
	Anti-scalding warning	The outer shell temperature of the AC COUPLED ESS is very high when it is working, there is a risk of burns, so it is strictly forbidden to touch it.
	Operation Alert	There are potential dangers when the AC COUPLED ESS is powered on. Please take corresponding protection when operating the inverter.

	CE Marking	The AC COUPLED ESS complies with the EU low voltag directive.
	View Instructions	Please read the user manual before installation.

2.4 Appearance Description

Appearance

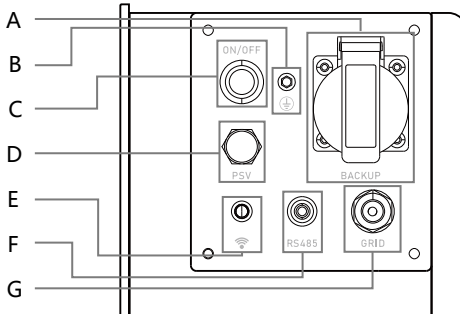

A	Backup
B	GND
C	Switch
D	PSV
E	WIFI
F	RS485
G	Grid

Product Dimensions

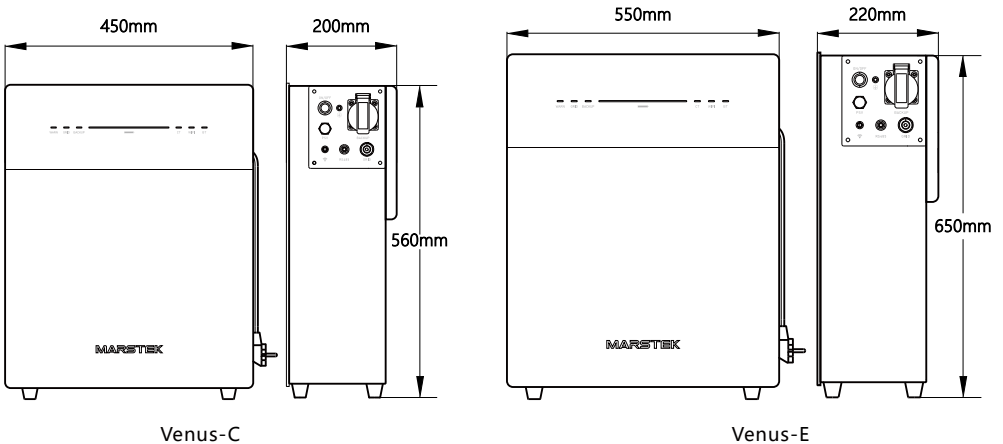

2.5 Working Mode

The VENUS series AC COUPLED ESS has three operating methods, which are:

Anti-reverse current method	In this method, the device will automatically search for CT equipment connected to the same home network. Based on the household electricity consumption information collected by the CT equipment, it will provide real-time output and grid-connected power compensation to offset household load losses.
Manual method	In this method, the device provides a fixed power output for grid-connected during the user-set time periods. If a specific time period is not set, there will be no grid-connected output.
Trade method	In the power trading mode, the user sets the charging and discharging electricity price. When the local electricity price obtained is lower than the set charging price, the AC COUPLED ESS will charge. When the local electricity price is higher than the set price, the AC COUPLED ESS sells electricity.

3. Installation Instructions

3.1 Pre-installation inspection

- Before unpacking the device, check the packaging for visible damage, such as holes, cracks, or other signs of possible internal damage, and check the model number of the device. If there are any abnormalities in the packaging or the energy storage model does not match, do not unpack it and contact your dealer as soon as possible.
- After unpacking the device, check that the delivery items are complete and that there is no visible external damage. If anything is missing or damaged, contact your dealer.

3.2 Select installation location









- Support floor installation, installation angle requirements:
 - The energy storage device cannot be installed with the device tilted forward, horizontal, inverted, backward or sideways.
 - For the installation location, please choose a solid brick-concrete structure, concrete wall and floor. If other types of walls and floors are selected, the walls and floors must be made of flame-retardant materials and meet the load-bearing requirements of the equipment.
 - When installing the all-in-one machine, ensure that there are no other equipment (except Venus-related equipment and awnings) and flammable or explosive items around it, and reserve enough space to ensure installation heat dissipation and safety isolation requirements.





* Note:

- In the actual installation environment, the open circuit voltage of the photovoltaic module shall not exceed the maximum voltage that the DC input side of the AC COUPLED ESS can withstand. If the DC input voltage of the AC COUPLED ESS exceeds this voltage, the AC COUPLED ESS may be damaged.
- The DC terminals of the AC COUPLED ESS are printed with "+" and "-". This mark does not indicate the positive or negative current, but only the type of terminal. Among them, "+" indicates the male end, and "-" indicates the female end.

3.3 Installing Tools

Installation tools include but are not limited to the recommended tools listed in the table below. Other auxiliary tools may be used as appropriate during on-site installation.

Screwdrivers		Multimeter	
Wrench		Measuring tape	
Diagonal pliers		Cable ties	
Insulating gloves		Insulated shoes	

Tool knife		Protective glasses	
Wire strippers		Marker pen	

3.4 Equipment Installation

There are two method for installation: Floor installation and wall-mounted installation.

Step 1: Dimensions

There needs to be at least 150mm of space between the top and rear of the machine to ensure that there are no other devices around and no obstructions to meet the requirements of heat dissipation and safety isolation.

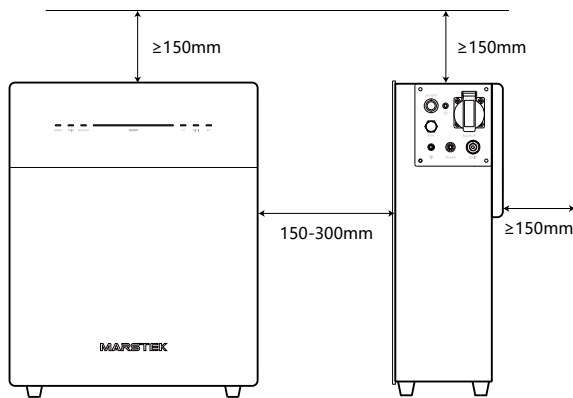

Step 2: Choose a method for fixed AC COUPLED ESS

1. For floor installation, put C on the bottom of AC COUPLED ESS. Mention: The quality of C is four.
2. For wall-mounted installation, there is no need to install C. Fix B and D on the AC COUPLED ESS, and fix A on the wall. Tightening A and B.

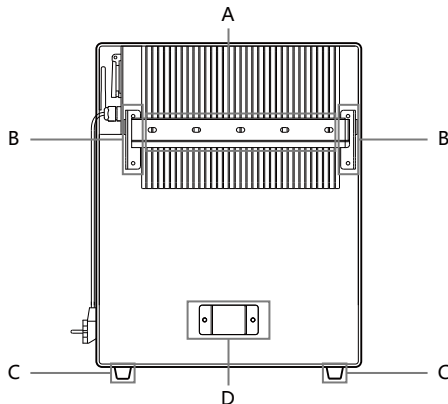

Step 3: Wiring

1. Insert the plug of the AC line into the socket and connect it to the local power grid.
2. Connect the antenna to the position shown in the figure and tighten the threads.
3. Backup terminal, for supplying power to the load.

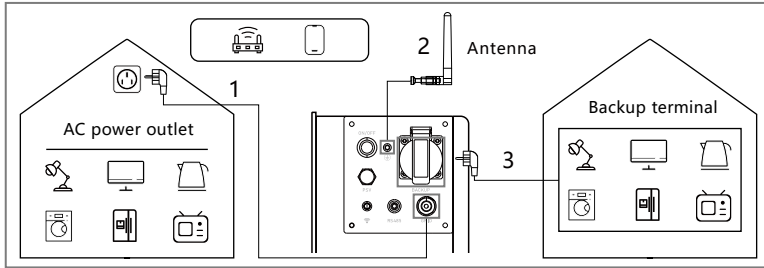

3.5 Installation And Debugging

Device startup

After connecting the device, short press the power button on the back for 1 second, the power button lights up, and the device enters the power-on state. After a while, the device LED lights up. Normally, the grid and battery status indicator lights are constant.

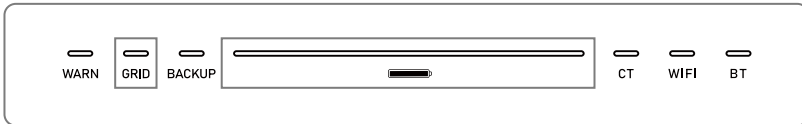

WIFI Configuration



After the device is started, click the wifi button on the APP device page to enter the wifi configuration page. At this time, the device will automatically search for nearby wifi hotspot information, select the wifi hotspot you need to connect to, and enter the correct password. After waiting for a while, the device will complete the wifi connection. After the wifi is successfully connected, the wifi button will turn green.

Power generation mode setting

When the device leaves the factory, the default power generation mode is automatic mode. If you need to switch to manual mode, the user can switch the power generation mode by clicking the switch button on the home page of the screen.



Automatic mode: When the CT connection indicator light is green, the device can automatically adjust the grid-connected output power, and the user does not need to make additional settings. (For CT connection instructions, please refer to the CT instruction manual).



Manual mode: In manual mode, the user needs to click the button on the right to set the grid-connected power. After the setting is completed, the device will output grid-connected power according to the date and time period set by the user.



Transaction mode: In transaction mode, users need to select the local country or region, select the corresponding power company, and set the charging and discharging price.

For more information about power generation mode, please refer to Section 2.5.

Device shutdown

Press and hold the power off button on the back of the device, and release it after 3 seconds (or release it after the button flashes 3 times). The LED light will go out and the device will enter the power off state.

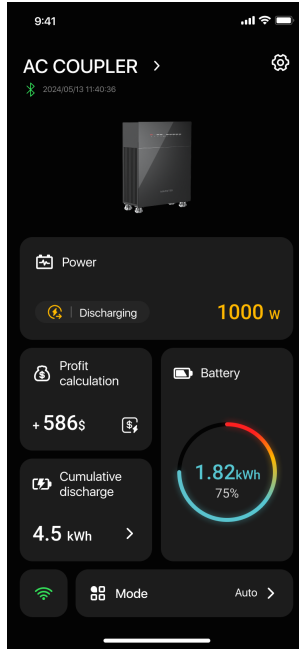

Home page display



Charging and discharging information, displaying charging power or discharging power.



To earn profits from electricity trading, you need to configure charging and discharging electricity prices.



Today's discharge amount.



Battery information display, showing the current remaining battery power and remaining power percentage.



The WIFI connection status is displayed. Click it to enter the WIFI configuration interface.



Working mode switching button. Click it to switch the device between various grinding times. For detailed description of the modes, please refer to Section 2.5.

4.

Stop Debugging

4.1 Stop debugging

Disconnect all photovoltaic inputs and AC grid-connected connections of the AC COUPLED ESS, remove all connecting cables from the AC COUPLED ESS, and put the AC COUPLED ESS into its original packaging.

4.2 Storage And Transportation

- The storage temperature of the AC COUPLED ESS is -30°C to 80°C.
- To facilitate transportation and subsequent handling, MARSTEK packaging is specially designed to protect the components. When transporting equipment, especially by road, it is necessary to adopt correct methods to protect components (especially electronic devices) to prevent them from being affected by severe impact, moisture, vibration and other factors.
- Please check the condition of the parts to be shipped. After receiving the AC COUPLED ESS, check the packaging for damage and confirm that all items have been received. If there is any damage to the appearance or parts are missing, please call the carrier immediately. If the parts of the AC COUPLED ESS are damaged, please contact the supplier or authorized dealer to apply for repair/replacement and consult the relevant procedures.
- Please dispose of the packaging materials properly to avoid accidental personal injury.

4.3 Disposal

- If the device will not be used immediately or needs to be stored for a long time, please make sure the packaging is intact.
- When storing the AC COUPLED ESS for a long time, the equipment must be stored in a well-ventilated indoor area that will not cause damage to the equipment components.
- When restarting equipment that has been out of service for a long time, a comprehensive inspection of the equipment is required.
- Randomly discarding the scrapped AC COUPLED ESS may harm the environment. Please properly dispose of the scrapped AC COUPLED ESS in accordance with local regulations.

5. Troubleshooting

5.1 Troubleshooting Checklist

Codes	Alarm range	Alarm status	Suggested treatments
400	Inverter Side	Overheat Protection	<ol style="list-style-type: none"> 1. Check whether the ventilation of the inverter installation location is good and whether the ambient temperature exceeds the maximum allowable ambient temperature range. 2. If there is no ventilation or the ambient temperature is too high, please improve its ventilation and heat dissipation conditions. 3. If the fault still exists or is triggered frequently, please contact the technical team.
401	Inverter Side	Self-test failed	<ol style="list-style-type: none"> 1. Please try to power off and restart. 2. If the fault is triggered frequently, please contact the technical team.
402	Inverter Side	EEPROM read and write exception	<ol style="list-style-type: none"> 1. Please try to power off and restart. 2. If the fault is triggered frequently, please contact the technical team.
405	Inverter Side	Off-grid output over-power protection	<ol style="list-style-type: none"> 1. The instantaneous power on the off-grid side is too high, please reduce the power consumption of the off-grid side. 2. If it is still triggered under low power load, please contact the technical team.
410-430	Inverter Side	Abnormality within the device	<ol style="list-style-type: none"> 1. The inverter is abnormal inside. Wait half a minute for the function to return to normal. 2. If it is triggered frequently, try to power off and restart. 3. If the fault is still triggered frequently, please contact the technical team.
431	BAT Side	Unable to communicate with BMS	<ol style="list-style-type: none"> 1. It may be caused by low battery voltage. Connect and wait for 5 minutes to slowly activate the battery. It disappears after activating the battery. 2. If the fault still exists or is triggered frequently, please contact the technical team.
432	BAT Side	Battery overvoltage	If the fault is triggered frequently, please contact the technical team.

433	BAT Side	Battery overcurrent	If the fault is triggered frequently, please contact the technical team.
434	BAT Side	Battery undervoltage	1. Please connect the grid-connected interface. 2. If the fault is triggered frequently, please contact the technical team.
440/441	Grid Side	Grid overvoltage	1. Grid fluctuations and loose lines may trigger this fault. 2. Check whether the grid is connected correctly and wait for the grid to return to normal.
442	Grid Side	Grid undervoltage	1. Grid fluctuations and loose lines may trigger this fault. 2. Check whether the grid is connected correctly and wait for the grid to return to normal.
443	Grid Side	Grid overfrequency	1. Grid fluctuations and loose lines may trigger this fault. 2. Check whether the grid is connected correctly and wait for the grid to return to normal.
444	Grid Side	Grid underfrequency	1. Grid fluctuations and loose lines may trigger this fault. 2. Check whether the grid is connected correctly and wait for the grid to return to normal.
445	Grid Side	Grid-connected overcurrent	1. Please check whether the grid-side line connection is normal. If there is no problem, it will return to normal within one minute. 2. Restart the inverter. 3. If the fault still exists or is triggered frequently, please contact the technical team.
446	Grid Side	Grid fluctuations	1. Grid fluctuations and loose lines may trigger this fault. 2. Check whether the grid is connected correctly and wait for the grid to return to normal.
447	Inverter Side	DCI protection/ output DC component protection	1. Grid fluctuations and loose lines may trigger this fault. 2. Check whether the grid is connected correctly and wait for the grid to return to normal.

448	Inverter Side	DCV protection/grid voltage direct component protection	<ol style="list-style-type: none"> 1. Grid fluctuations and loose lines may trigger this fault. 2. Check whether the grid is connected correctly and wait for the grid to return to normal.
530/558		Over temperature limit	<ol style="list-style-type: none"> 1. Check whether the ventilation of the inverter installation location is good and whether the ambient temperature exceeds the maximum allowable ambient temperature range. 2. If there is no ventilation or the ambient temperature is too high, please improve its ventilation and heat dissipation conditions. 3. If the fault still exists or is triggered frequently, please contact the technical team.
559		Low temperature limit	<ol style="list-style-type: none"> 1. Check whether the ambient temperature meets the temperature requirements. 2. If the ambient temperature is normal but the fault still exists or is triggered frequently, please contact the technical team.
560		Low battery	<ol style="list-style-type: none"> 1. It will be triggered when the battery power is too low, please connect the grid interface. 2. If the fault still exists or is triggered frequently, please contact the technical team.
5C0		Bluetooth status is abnormal	<ol style="list-style-type: none"> 1. Please check whether you are using the correct device and the APP to connect the device. The error will be automatically eliminated after a period of time. 2. If the fault still exists or is triggered frequently, please contact the technical team.
5C1		OTA update failed	<ol style="list-style-type: none"> 1. It will be triggered when the OTA upgrade fails, and it will be automatically eliminated after a period of time after re-upgrading. 2. If the fault still exists or is triggered frequently, please contact the technical team.
5C2/5C3 /5C4		Abnormal WiFi signal	<ol style="list-style-type: none"> 1. Please check whether the WIFI connection between the device and the home network is normal. 2. If the fault persists or is triggered frequently, please contact the technical team.
5C8-5CB		Network abnormal	<ol style="list-style-type: none"> 1. Check if your home network is normal. It may be triggered occasionally when the network fluctuates and will automatically disappear after a period of time. 2. If the fault persists or occurs frequently, please contact the technical team.
5D2		CT connection abnormality	<ol style="list-style-type: none"> 1. Please check whether the CT is properly connected to the home network and ensure the stability of the home network. 2. If the fault still exists or is triggered frequently, please contact the technical team.

5D3		Line sequence detection failed	<p>1. It will occasionally be triggered when the household load fluctuates too much or the network fluctuates, and will automatically disappear after a period of time.</p> <p>2. Check whether the CT sensor is connected normally.</p>
-----	--	--------------------------------	--

Restart method: Put the device into sleep mode and unplug the power connector. Wait for 2 minutes, then wake up the device and plug it back into the power connector.

5.2 On-site Inspection

If there is a problem with the AC COUPLED ESS, please follow the steps below to troubleshoot (only for professional technicians)

1	Check that the grid voltage and frequency are within the range specified in the Technical Specifications section of this manual.
2	Check whether the grid connection and PV input line connection are normal, confirm whether the PV module voltage is within the range specified in the "Technical Specifications" of this manual, and confirm whether the equipment is normally connected to the grid.
3	If the problem persists, call technical support.
4	Do not repair the AC COUPLED ESS without authorization. If the fault cannot be eliminated, please contact the local dealer.

5.3 General Maintenance

- Maintenance work must be performed by authorized personnel, and authorized personnel are responsible for reporting abnormalities.
- When performing maintenance, be sure to wear personal protective equipment.
- During normal operation of the AC COUPLED ESS, please check the environmental conditions regularly to ensure that the environmental conditions meet the requirements of the "Technical Specifications" and ensure that the equipment is not exposed to severe weather.
- If you find any problem, do not use the device. Please wait until the problem is solved before resuming normal use.
- Check the various components of the AC COUPLED ESS regularly every year to ensure that each component is in good condition and the heat dissipation components are not blocked in any way.
- To clean the device, use a vacuum cleaner or a special brush.

Danger	Do not dismantle the AC COUPLED ESS without authorization! To ensure safety and insulation performance, users are prohibited from repairing internal parts!
Warn	The AC output harness (AC tapping cable on the AC COUPLED ESS) must not be replaced. If the wires are damaged, the device should be scrapped.
Warn	Unless otherwise specified, the equipment must be disconnected from the grid (disconnect the socket) and the PV input during maintenance.
Warn	Never use rags made of filamentous or corrosive materials to clean the device, as this may generate static electricity or cause corrosion.
Warn	Do not repair the product yourself. When repairing, use only qualified parts.
Tips	Each branch line should be equipped with a circuit breaker, but it is not necessary to have a central protective device.

5.4 Equipment Replacement

A. Removal of AC COUPLED ESS

- Disconnect power at the AC branch circuit breaker.
- Use the PV input terminal disconnect tool to remove the PV input cables.
- Unscrew the AC grid-connected thread and remove the cable.
- After unscrewing the grounding screw and removing the grounding cable, you can move the AC COUPLED ESS.

B. Replacement of the AC COUPLED ESS in the monitoring platform

- Please write down the serial number of your new balcony photovoltaic integrated machine.
- Please make sure that the AC branch circuit breaker is turned off, and then install the replacement parts according to the AC COUPLED ESS machine installation steps.

6. Technical Specifications

Specification Type	Venus-C	Venus-E
Battery Info		
Rated Voltage	51.2V	
Battery Energy	2560Wh	5120Wh
Life Cycle (Times)	>6000(25°C)	
Battery Type	LiFePO4	
Depth of Discharge	90%	
Capacity	50Ah	100Ah
AC Input/Output (On Grid)		
Rated Input Power	2.5kW	
Operating Phase	L/N/PE	
Rated Grid Voltage	230V	
Grid Voltage Range	187V-253V	
Rated Grid Frequency	50Hz	
Rated Grid Input/Output Current	10.9A	
Power Factor	>0.99(Default)/0.8 Leading~0.8 Lagging(Adjustable)	
THDi	<3%	
AC Output (Off Grid)		
Rated Off-grid Output Power	2.5kVA	
Max.Output Power	3.5kVA,10s	
Rated Output Current	10.9A	
Rated Output Voltage	230V	
Rated Output Voltage Freq.	50Hz	
THDu(Linear Load)	<3%	
Efficiency		
Battery-AC Side Max.Efficiency	>93.5%	
Protection		
Protection level	I	
Overvoltage/Voltage Withstand Level	DC II/AC III	
General Parameter		
Isolation Type	Isolated	
Operating Temperature Range	-20 ~+ 55°C (store-30 ~+ 85°C)	
Relative humidity	0-95%	

Ingress Protection	IP65	
Cooling Strategy	Natural Convection	
Max.Operating Altitude	2000m	
On-grid Connection Standard	EN50549-1	
Regulatory	IEC62040、IEC62477	
EMC	IEC/EN 61000-6-1/-2/-3/-4	
Dimension(L*W*H)	450*200*560mm	550*220*650mm
Weight	41kg	46kg
Addition Date		
On-grid AC Connection	Three-wire Household Plug(Euro16A)	
Display	LED	
Supported Communication Interface	WIFI&RS-485 (Waterproof Aviation Plug)	

* Note 1: Rated voltage/frequency range can be changed according to the requirements of local power department.

* Note 2: Please refer to local electrical regulations to determine the number of the AC COUPLED ESS that can be connected to each branch.