

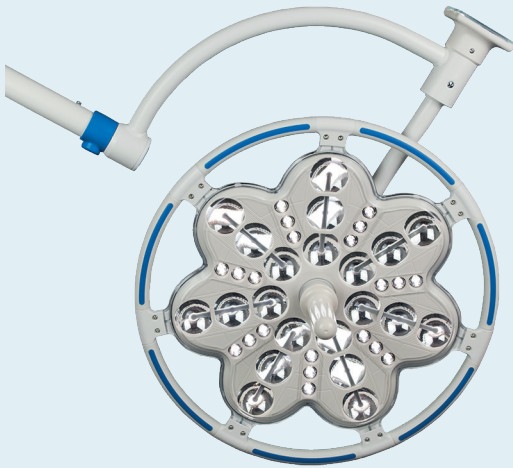

SURGICAL LIGHT EMALED® 300D or EMALED® 300D+



The surgical light EMALED 300D or EMALED 300D+ grants a high light quality and optimal illumination for diagnostical examinations and surgical interventions. The 4-step focusing via the control panel with LCD display enables to adapt the light field as needed.

TECHNICAL DETAILS

	EMALED 300D	EMALED 300D+
Illumination (at 1 m)	100.000 lx	up to 160.000 lx
Lighting intensity	10 - 100 %	10 - 100 %
Focusable diameter of lightning field D10	150 - 300 mm	150 - 300 mm
Operating distance	70 - 140 cm	70 - 140 cm
Colour temperature	4.500 K	4.500 K
Colour rendering index	96 Ra	96 Ra
Life expectancy of LEDs	50.000 hrs	50.000 hrs
Diameter of light head	440 mm	440 mm
Number of LEDs	42	42
Main voltage	230 V	230 V
Frequency	50 - 60 Hz	50 - 60 Hz
Power consumption	24 VA	24 VA
Height adjustment	1.500 mm	1.500 mm
Weight of lighting element	4,0 kg	4,0 kg
Weight of complete system	ca. 30 kg	ca. 30 kg

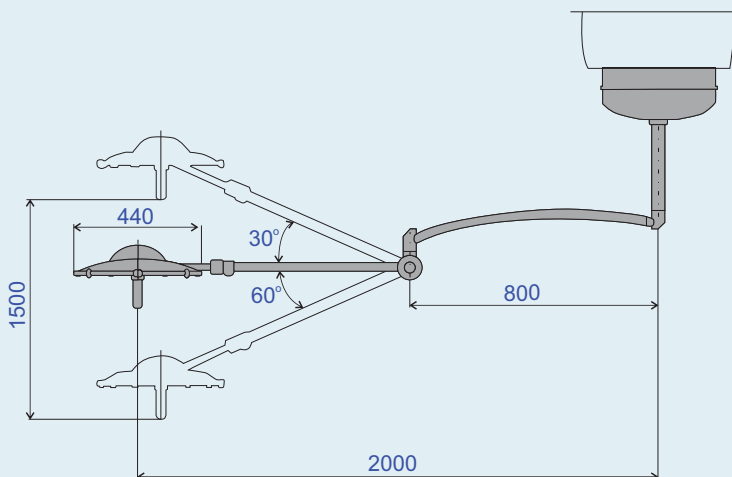

- Natural colour rendering
- Shadow-free illumination
- Barely noticeable heating of the light head
- No moveable parts in the light head
- Low maintenance requirements
- Adjustable illumination in 10 steps
- Powder coated aluminum case
- High flexibility: 360° rotation horizontal
- Two autoclavable handles are included (additional handles can be ordered any time)
- 4-step focusing via the control panel with LCD display
- Optionally: cardanic system

