

# FIBARO SMART IMPLANT

**FGBS-222**



## Table of contents

1: Important safety information	4
2: Description and features	5
2.1: Description	5
2.2: Main features	5
3: Specifications	6
4: Installation	7
4.1: Before installation	7
4.2: Connection with alarm line	9
4.3: Connection with DS18B20	10
4.4: Connection with DHT22	10
4.5: Connection with 2-wire 0-10V sensor	11
4.6: Connection with 3-wire 0-10V sensor	11
4.7: Connection with binary sensor	12
4.8: Connection with button	13
4.9: Connection with gate opener	14
5: Adding to Z-Wave network	15
5.1: Adding manually	15
5.2: Adding using Smart Start	15
6: Removing from Z-Wave network	16
7: Operating the device	17
7.1: Controlling the outputs	17
7.2: Visual indications	17
7.2: Menu	18
7.4: Resetting to factory defaults	18
8: Z-Wave range test	19
9: Activating scenes	20
10: Configuration	21
10.1: Associations	21
10.2: Advanced parameters	21
11: Z-Wave specification	29
12: Regulations	37

# 1: Important safety information

## Read this manual before attempting to install the device!

 Failure to observe recommendations included in this manual may be dangerous or cause a violation of the law. The manufacturer, Fibar Group S.A. will not be held responsible for any loss or damage resulting from not following the instructions of operating manual.

## Do not modify!

 Do not modify this device in any way not included in this manual. It might result in losing warranty privileges otherwise.

## Other devices

 The manufacturer, Fibar Group S.A. will not be held responsible for any damage or loss of warranty privileges for other connected devices if the connection is not compliant with their manuals.

## DANGER!

 The device is powered with a secure voltage. Nevertheless, the user should be careful or should commission the installation to a qualified person.

## DANGER!

 To avoid risk of electrical shock, do not operate the device with wet or moist hands.

## This product is intended for indoor use only in dry locations.

 Do not use in damp or wet locations, near a bathtub, sink, shower, swimming pool, or anywhere else where water or moisture are present.

## Not a toy!

 This product is not a toy. Keep away from children and animals!

## 2: Description and features

### 2.1: Description

**FIBARO Smart Implant** allows to enhance the functionality of wired sensors and other devices by adding Z-Wave network communication.

You can connect binary sensors, analog sensors, DS18B20 temperature sensors or DHT22 humidity and temperature sensor to report their readings to the Z-Wave controller.

It can also control devices by opening/closing output contacts independently of the inputs.

### 2.2: Main features

- Allows for connecting sensors:
  - » 6 DS18B20 sensors,
  - » 1 DHT sensor,
  - » 2 2-wire analog sensor,
  - » 2 3-wire analog sensor,
  - » 2 binary sensors.
- Built-in temperature sensor.
- Supports Z-Wave network Security Modes: S0 with AES-128 encryption and S2 Authenticated with PRNG-based encryption.
- Works as a Z-Wave signal repeater (all non-battery operated devices within the network will act as repeaters to increase reliability of the network).
- May be used with all devices certified with the Z-Wave Plus certificate and should be compatible with such devices produced by other manufacturers.

 The device is a Security Enabled Z-Wave Plus product and a Security Enabled Z-Wave Controller must be used in order to fully utilize the product.

### 3: Specifications

Power supply	9-30V DC $\pm$ 10%
Inputs	2 0-10V or digital inputs 1 serial 1-wire input
Outputs	2 potential-free outputs
Supported digital sensors	6 DS18B20 or 1 DHT22
Maximum current on outputs	150mA
Maximum voltage on outputs	30V DC / 20V AC $\pm$ 5%
Built-in temperature sensor measurement range	-55°C–126°C (-67°F–259°F)
Operating temperature	0–40°C (32–104°F)
Radio protocol	Z-Wave (500 series chip)
Radio frequency	868.4 or 869.8 MHz EU; 908.4, 908.42 or 916.0 MHz US; 921.4 or 919.8 MHz ANZ; 869.0 MHz RU;
Transmit power	EIRP max. 7dBm
Range	up to 50m (164 ft) outdoors up to 40m (131 ft) indoors (depending on terrain and building structure)
Dimensions (Length x Width x Height)	29 x 18 x 13 mm (1.14" x 0.71" x 0.51")
Compliance with EU directives	RoHS 2011/65/EU RED 2014/53/EU

**i** Radio frequency of individual device must be same as your Z-Wave controller. Check information on the box or consult your dealer if you are not sure.

## 4: Installation

### 4.1: Before installation



**Connecting the device in a manner inconsistent with this manual may cause risk to health, life or material damage.**

- Connect only in accordance with one of the diagrams,
- The device is powered with secure voltage; nevertheless, the user should be extra careful or should commission the installation to a qualified person,
- **Do not** connect devices which are not compliant with the specification,
- **Do not** connect other sensors than DS18B20 or DHT22 to SP and SD terminals,
- **Do not** connect sensors to SP and SD terminals with wires longer than 3 meters,
- **Do not** load the device outputs with a current exceeding 150mA,
- Every connected device should be compliant with the relevant safety standards,
- Unused lines should be left insulated.

#### **Tips for arranging the antenna:**

- Locate the antenna as far from metal elements as possible (connecting wires, bracket rings, etc.) in order to prevent interferences,
- Metal surfaces in the direct vicinity of the antenna (e.g. flush mounted metal boxes, metal door frames) may impair signal reception!
- **Do not** cut or shorten the antenna - its length is perfectly matched to the band in which the system operates.
- Make sure no part of the antenna sticks out of the wall switch box.

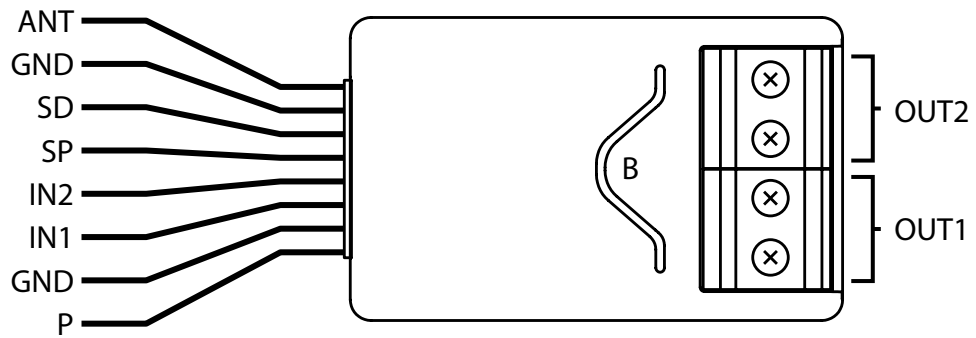
**Notes for diagrams:**

ANT (black) – antenna

GND (blue) – ground conductor

SD (white)– signal conductor for DS18B20 or DHT22 sensor

SP (brown) – power supply conductor for DS18B20 or DHT22 sensor (3.3V)

IN2 (green) – input no. 2

IN1 (yellow) – input no. 1

GND (blue) – ground conductor

P (red) – power supply conductor

OUT1 – output no. 1 assigned to input IN1

OUT2 – output no. 2 assigned to input IN2

B – service button (used to add/remove the device)



## 4.2: Connection with alarm line

1. Turn off the alarm system.
2. Connect with one of the diagrams below:

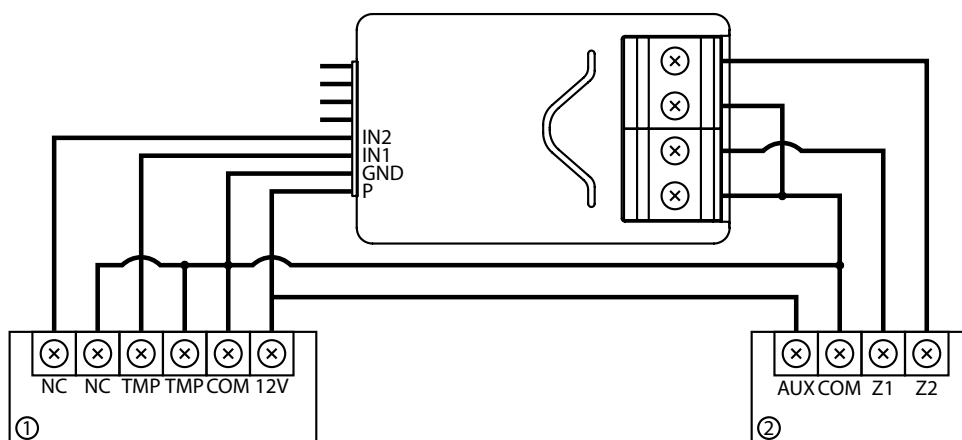

Diagram 1: Example connection with regular alarm line  
(1 – alarm sensor, 2 – alarm system hub)

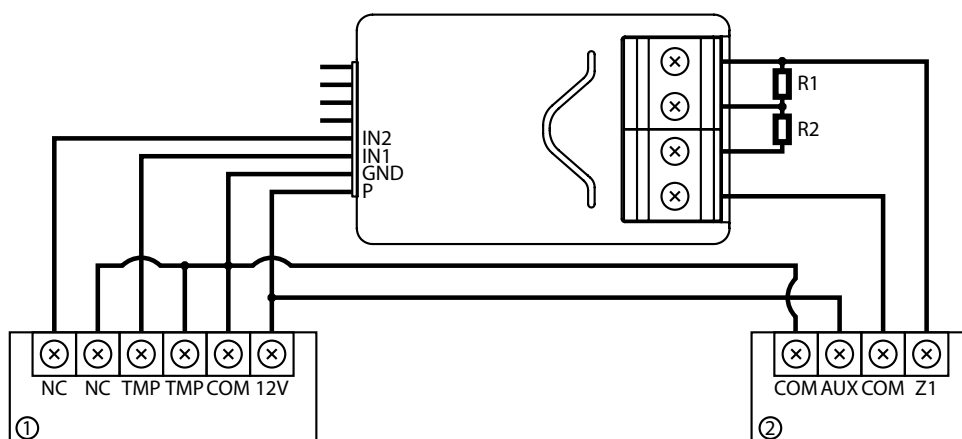

Diagram 2: Example connection with parametric alarm line  
(1 – alarm sensor, 2 – alarm system hub)

3. Verify correctness of connection.
4. Arrange the device and its antenna in the housing.
5. Power the device.
6. Add the device to the Z-Wave network.
7. Change values of parameters:
  - Connected to IN1:
    - » Normally close: change parameter 20 to 0
    - » Normally open: change parameter 20 to 1
  - Connected to IN2:
    - » Normally close: change parameter 21 to 0
    - » Normally open: change parameter 21 to 1

### 4.3: Connection with DS18B20

The DS18B20 sensor may easily be installed wherever very precise temperature measurements are required. If proper protective measures are undertaken, the sensor may be used in humid environments or under water, it may be embedded in concrete or placed under the floor.

You can connect up to 6 DS18B20 sensors in parallel to SP-SD terminals.

1. Disconnect power.
2. Connect with the diagram below:

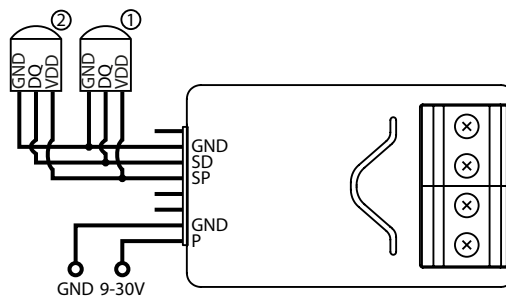

Diagram 3: Example connection with 2 DS18B20 sensors  
(1,2 – DS18B20 sensor)

3. Verify correctness of connection.
4. Power the device.
5. Add the device to the Z-Wave network.

### 4.4: Connection with DHT22

The DHT22 sensor may easily be installed wherever humidity and temperature measurements are required.

You can connect only 1 DHT22 sensor to TP-TD terminals.

1. Disconnect power.
2. Connect with the diagram below:

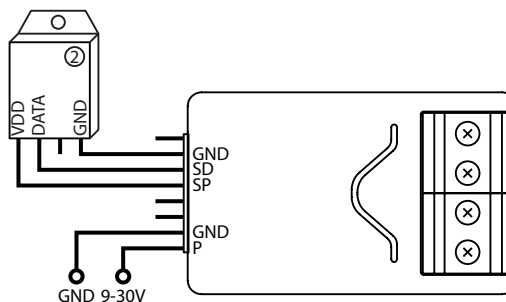

Diagram 4: Example connection with DHT22 sensor  
(1 – DHT22 sensor)

3. Verify correctness of connection.
4. Power the device.
5. Add the device to the Z-Wave network.

#### 4.5: Connection with 2-wire 0-10V sensor

The 2-wire analog sensor requires pull-up resistor.  
 You can connect up to 2 analog sensors to IN1/IN2 terminals.  
 The 12V supply is required for these type of sensors.

1. Disconnect power.
2. Connect with the diagram below:

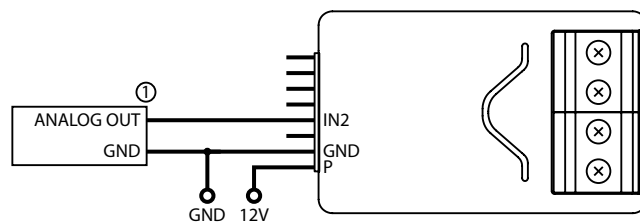

Diagram 5: Example connection with 2-wire analog sensor to IN2 input

(1 – 2-wire analog sensor)

3. Verify correctness of connection.
4. Power the device.
5. Add the device to the Z-Wave network.
6. Change values of parameters:
  - Connected to IN1: change parameter 20 to 5
  - Connected to IN2: change parameter 21 to 5

#### 4.6: Connection with 3-wire 0-10V sensor

You can connect up to 2 analog sensors IN1/IN2 terminals.

1. Disconnect power.
2. Connect with the diagram below:

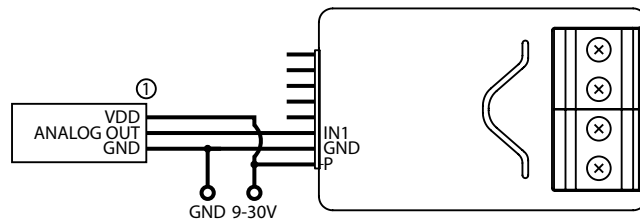

Diagram 6: Example connection with 3-wire analog sensor to IN1 input

(1 – 3-wire analog sensor)

3. Verify correctness of connection.
4. Power the device.
5. Add the device to the Z-Wave network.
6. Change values of parameters:
  - Connected to IN1: change parameter 20 to 4
  - Connected to IN2: change parameter 21 to 4

#### 4.7: Connection with binary sensor

You connect normally opened or normally binary sensors to IN1/IN2 terminals.

1. Disconnect power.
2. Connect with the diagram below:

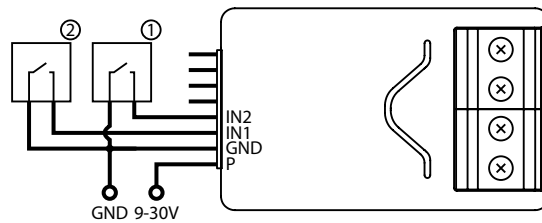

Diagram 7: Example connection with 2 binary sensors  
(1,2 – binary sensor)

3. Verify correctness of connection.
4. Power the device.
5. Add the device to the Z-Wave network.
6. Change values of parameters:
  - Connected to IN1:
    - » Normally close: change parameter 20 to 0
    - » Normally open: change parameter 20 to 1
  - Connected to IN2:
    - » Normally close: change parameter 21 to 0
    - » Normally open: change parameter 21 to 1

## 4.8: Connection with button

You can connect monostable or bistable switches to IN1/IN2 terminals to activate scenes.

1. Disconnect power.
2. Connect with the diagram below:

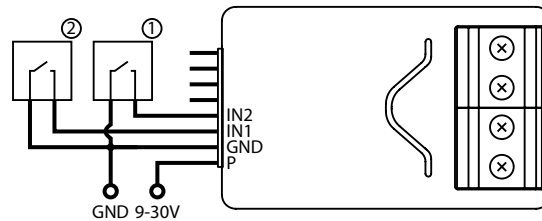

Diagram 8: Example connection with 2 buttons  
(1,2 – button)

3. Verify correctness of connection.
4. Power the device.
5. Add the device to the Z-Wave network.
6. Change values of parameters:
  - Connected to IN1:
    - » Monostable: change parameter 20 to 2
    - » Bistable: change parameter 20 to 3
  - Connected to IN2:
    - » Monostable: change parameter 21 to 2
    - » Bistable: change parameter 21 to 3

## 4.9: Connection with gate opener

Smart Implant can be connected to different devices to control them. In this example it is connected to gate opener with impulse input (every impulse will start and stop the gate motor, alternately opening/closing)

1. Disconnect power.
2. Connect with the diagram below:

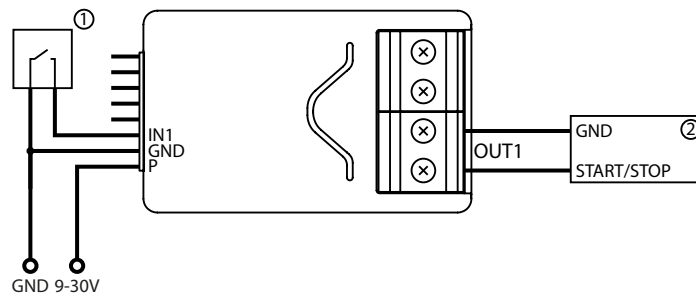

Diagram 9: Example gate opener

(1 – monostable button, 2 – gate opener controller)

3. Verify correctness of connection.
4. Power the device.
5. Add the device to the Z-Wave network.
6. Change values of parameters:
  - Connected to IN1 and OUT1:
    - » Change parameter 20 to 2 (monostable button)
    - » Change parameter 156 to 1 (0.1s)
  - Connected to IN2 and OUT2:
    - » Change parameter 21 to 2 (monostable button)
    - » Change parameter 157 to 1 (0.1s)

## 5: Adding to Z-Wave network

**Adding (Inclusion)** – Z-Wave device learning mode, allowing to add the device to existing Z-Wave network.

### 5.1: Adding manually

To add the device to the Z-Wave network **manually**:

1. Power the device.
2. Set the main controller in (Security/non-Security Mode) add mode (see the controller's manual).
3. Quickly, triple click button on the device housing or switch connected to IN1 or IN2.
4. If you are adding in Security S2 Authenticated, scan the DSK QR code or input the 5-digit PIN code (label on the bottom of the box).
5. LED will start blinking yellow, wait for the adding process to end.
6. Successful adding will be confirmed by the Z-Wave controller's message.

### 5.2: Adding using Smart Start

**SmartStart** enabled products can be added to SmartStart enabled Z-Wave controller by scanning the Z-Wave QR Code present on the product. SmartStart product will be added automatically within 10 minutes of being switched on in the network range.

To add the device to the Z-Wave network **using Smart Start**:

1. Set the main controller in Security S2 Authenticated add mode (see the controller's manual).
2. Scan the DSK QR code or input the 5-digit PIN code (label on the bottom of the box).
3. Power the device.
4. LED will start blinking yellow, wait for the adding process to end.
5. Successful adding will be confirmed by the Z-Wave controller's message.

 In case of problems with adding the device, please re-set the device and repeat the adding procedure.

## 6: Removing from Z-Wave network

**Removing (Exclusion)** – Z-Wave device learning mode, allowing to remove the device from existing Z-Wave network. Removing also results in resetting the device to factory defaults.

To **remove** the device from the Z-Wave network:

1. Power the device.
2. Set the main controller into remove mode (see the controller's manual).
3. Quickly, triple click button on the device housing or switch connected to IN1 or IN2.
4. LED will start blinking yellow, wait for the removing process to end.
5. Successful removing will be confirmed by the Z-Wave controller's message.

 Removing using switch connected to IN1 or IN2 works only if parameter 20 (IN1) or 21 (IN2) is set to 2 or 3 and parameter 40 (IN1) or 41 (IN2) does not allow sending scenes for triple click.



## 7: Operating the device

### 7.1: Controlling the outputs

It is possible to control the outputs with the inputs or with the **B-button**:

- single click – switch OUT1 output
- double click – switch OUT2 output

### 7.2: Visual indications

The built-in LED light shows current device status.

#### **After powering the device:**

- Green – device added to a Z-Wave network (without Security S2 Authenticated)
- Magenta – device added to a Z-Wave network (with Security S2 Authenticated)
- Red – device not added to a Z-Wave network

#### **Update:**

- Blinking cyan – update in progress
- Green – update successful (added without Security S2 Authenticated)
- Magenta – update successful (added with Security S2 Authenticated)
- Red – update not successful

#### **Menu:**

- 3 green blinks – entering the menu (added without Security S2 Authenticated)
- 3 magenta blinks – entering the menu (added with Security S2 Authenticated)
- 3 red blinks – entering the menu (not added to a Z-Wave network)
- Magenta – range test
- Yellow – reset

## 7.2: Menu

**Menu** allows to perform Z-Wave network actions. In order to use the menu:

1. Press and hold the button to enter the menu, device blinks to signal adding status (see 7.2: Visual indications).
2. Release the button when device signals desired position with colour:
  - **MAGENTA** - start range test
  - **YELLOW** - reset the device
3. Quickly click the button to confirm.

## 7.4: Resetting to factory defaults

Reset procedure allows to restore the device back to its factory settings, which means all information about the Z-Wave controller and user configuration will be deleted.

 Resetting the device is not the recommended way of removing the device from the Z-Wave network. Use reset procedure only if the primary controller is missing or inoperable. Certain device removal can be achieved by the procedure of removing described.

1. Press and hold the button to enter the menu.
2. Release button when the device glows yellow.
3. Quickly click the button to confirm.
4. After few seconds the device will be restarted, which is signalled with the red colour.

## 8: Z-Wave range test

The device has a built in Z-Wave network main controller's range tester.

**i** To make Z-Wave range test possible, the device must be added to the Z-Wave controller. Testing may stress the network, so it is recommended to perform the test only in special cases.

### To test the main controller's range:

1. Press and hold the button to enter the menu.
2. Release button when the device glows magenta.
3. Quickly click the button to confirm.
4. Visual indicator will indicate the Z-Wave network's range (range signaling modes described below).
5. To exit Z-Wave range test, press the button briefly.

### Z-Wave range tester signalling modes:

- **Visual indicator pulsing green** - the device attempts to establish a direct communication with the main controller. If a direct communication attempt fails, the device will try to establish a routed communication, through other modules, which will be signalled by visual indicator pulsing yellow.
- **Visual indicator glowing green** - the device communicates with the main controller directly.
- **Visual indicator pulsing yellow** - the device tries to establish a routed communication with the main controller through other modules (repeaters).
- **Visual indicator glowing yellow** - the device communicates with the main controller through the other modules. After 2 seconds the device will retry to establish a direct communication with the main controller, which will be signalled with visual indicator pulsing green.
- **Visual indicator pulsing violet** - the device does communicate at the maximum distance of the Z-Wave network. If connection proves successful it will be confirmed with a yellow glow. It's not recommended to use the device at the range limit.
- **Visual indicator glowing red** - the device is not able to connect to the main controller directly or through another Z-Wave network device (repeater).

**i** Communication mode of the device may switch between direct and one using routing, especially if the device is on the limit of the direct range.

## 9: Activating scenes

The device can activate scenes in the Z-Wave controller by sending scene ID and attribute of a specific action using Central Scene Command Class.

In order for this functionality to work connect monostable or bistable switch to the IN1 or IN2 input and set parameter 20 (IN1) or 21 (IN2) to 2 or 3.

By default scenes are not activated, set parameters 40 and 41 to enable scene activation for selected actions.

Switch	Action	Scene ID	Attribute
Switch connected to IN1 terminal	Switch clicked once	1	Key Pressed 1 time
	Switch clicked twice	1	Key Pressed 2 times
	Switch clicked thrice*	1	Key Pressed 3 times
	Switch held**	1	Key Held Down
	Switch released**	1	Key Released
Switch connected to IN2 terminal	Switch clicked once	2	Key Pressed 1 time
	Switch clicked twice	2	Key Pressed 2 times
	Switch clicked thrice*	2	Key Pressed 3 times
	Switch held**	2	Key Held Down
	Switch released**	2	Key Released

\* Activating triple clicks will disallow removing using input terminal.

\*\* Not available for toggle switches.

# 10: Configuration

## 10.1: Associations

**Association (linking devices)** - direct control of other devices within the Z-Wave system network e.g. Dimmer, Relay Switch, Roller Shutter or scene (may be controlled only through a Z-Wave controller).

Association ensures direct transfer of control commands between devices, is performed without participation of the main controller and requires associated device to be in the direct range.

**The device provides the association of 3 groups:**

**1st association group - “LifeLine”** reports the device status and allows for assigning single device only (main controller by default).

**2nd association group - “On/Off (IN1)”** is assigned to IN1 input terminal (uses Basic command class).

**3rd association group - “On/Off (IN2)”** is assigned to IN2 input terminal (uses Basic command class).

The device in 2nd and 3rd group allows to control 5 regular or multichannel devices per an association group, with the exception of “LifeLine” that is reserved solely for the controller and hence only 1 node can be assigned.

## 10.2: Advanced parameters

The device allows to customize its operation to user’s needs using configurable parameters.

The settings can be adjusted via Z-Wave controller to which the device is added. The way of adjusting them might differ depending on the controller.

In the FIBARO interface parameters are presented as simple options in Advanced Settings of the device.

### Parameters dependency

Many of the parameters are relevant only for specific input operating modes (parameters 20 and 21), consult the table below:

Parameter 20	No. 40	No. 47	No. 49	No. 150	No. 152	No. 63	No. 64
0 or 1		✓	✓	✓	✓		
2 or 3	✓						
4 or 5						✓	✓

Parameter 21	No. 41	No. 52	No. 54	No. 151	No. 153	No. 63	No. 64
0 or 1		✓	✓	✓	✓		
2 or 3	✓						
4 or 5						✓	✓

**Available parameters:**

20.	Input 1 - operating mode
This parameter allows to choose mode of 1st input (IN1). Change it depending on connected device.	
<b>Parameter size</b>	1B
<b>Default value</b>	2 (monostable button)
<b>Available values</b>	0 – Normally closed alarm input (Notification) 1 – Normally open alarm input (Notification) 2 – Monostable button (Central Scene) 3 – Bistable button (Central Scene) 4 – Analog input without internal pull-up (Sensor Multilevel) 5 – Analog input with internal pull-up (Sensor Multilevel)
21.	Input 2 - operating mode
This parameter allows to choose mode of 2nd input (IN2). Change it depending on connected device.	
<b>Parameter size</b>	1B
<b>Default value</b>	2 (monostable button)
<b>Available values</b>	0 – Normally closed alarm input (Notification CC) 1 – Normally open alarm input (Notification CC) 2 – Monostable button (Central Scene CC) 3 – Bistable button (Central Scene CC) 4 – Analog input without internal pull-up (Sensor Multilevel CC) 5 – Analog input with internal pull-up (Sensor Multilevel CC)

<b>24.</b>	<b>Inputs orientation</b>
This parameter allows reversing operation of IN1 and IN2 inputs without changing the wiring. Use in case of incorrect wiring.	
<b>Parameter size</b>	1B
<b>Default value</b>	0 (default)
<b>Available values</b>	0 – default (IN1 - 1st input, IN2 - 2nd input) 1 – reversed (IN1 - 2nd input, IN2 - 1st input)
<b>25.</b>	<b>Outputs orientation</b>
This parameter allows reversing operation of OUT1 and OUT2 inputs without changing the wiring. Use in case of incorrect wiring.	
<b>Parameter size</b>	1B
<b>Default value</b>	0 (default)
<b>Available values</b>	0 – default (OUT1 - 1st output, OUT2 - 2nd output) 1 – reversed (OUT1 - 2nd output, OUT2 - 1st output)
<b>40.</b>	<b>Input 1 - sent scenes</b>
This parameter defines which actions result in sending scene ID and attribute assigned to them (see 9: Activating scenes). Parameter is relevant only if parameter 20 is set to 2 or 3.	
<b>Parameter size</b>	1B
<b>Default value</b>	0 (no scenes sent)
<b>Available values</b>	1 – Key pressed 1 time 2 – Key pressed 2 times 4 - Key pressed 3 times 8 – Key hold down and key released
<b>41.</b>	<b>Input 2 - sent scenes</b>
This parameter defines which actions result in sending scene ID and attribute assigned to them (see 9: Activating scenes). Parameter is relevant only if parameter 21 is set to 2 or 3.	
<b>Parameter size</b>	1B
<b>Default value</b>	0 (no scenes sent)
<b>Available values</b>	1 – Key pressed 1 time 2 – Key pressed 2 times 4 - Key pressed 3 times 8 – Key hold down and key released

<b>47.</b>	<b>Input 1 - value sent to 2nd association group when activated</b>
<p>This parameter defines value sent to devices in 2nd association group when IN1 input is triggered (using Basic Command Class). Parameter is relevant only if parameter 20 is set to 0 or 1 (alarm mode).</p>	
<b>Parameter size</b>	2B
<b>Default value</b>	255
<b>Available values</b>	0-255
<b>49.</b>	<b>Input 1 - value sent to 2nd association group when deactivated</b>
<p>This parameter defines value sent to devices in 2nd association group when IN1 input is deactivated (using Basic Command Class). Parameter is relevant only if parameter 20 is set to 0 or 1 (alarm mode).</p>	
<b>Parameter size</b>	2B
<b>Default value</b>	0
<b>Available values</b>	0-255
<b>52.</b>	<b>Input 2 - value sent to 3rd association group when activated</b>
<p>This parameter defines value sent to devices in 3rd association group when IN2 input is triggered (using Basic Command Class). Parameter is relevant only if parameter 21 is set to 0 or 1 (alarm mode).</p>	
<b>Parameter size</b>	2B
<b>Default value</b>	255
<b>Available values</b>	0-255
<b>54.</b>	<b>Input 2 - value sent to 3rd association group when deactivated</b>
<p>This parameter defines value sent to devices in 3rd association group when IN2 input is deactivated (using Basic Command Class). Parameter is relevant only if parameter 21 is set to 0 or 1 (alarm mode).</p>	
<b>Parameter size</b>	2B
<b>Default value</b>	0
<b>Available values</b>	0-255



<b>150.</b>	<b>Input 1 - sensitivity</b>
This parameter defines the inertia time of IN1 input in alarm modes. Adjust this parameter to prevent bouncing or signal disruptions. Parameter is relevant only if parameter 20 is set to 0 or 1 (alarm mode).	
<b>Parameter size</b>	1B
<b>Default value</b>	10 (100ms)
<b>Available values</b>	1-100 (10ms-1000ms, 10ms step)
<b>151.</b>	<b>Input 2 - sensitivity</b>
This parameter defines the inertia time of IN2 input in alarm modes. Adjust this parameter to prevent bouncing or signal disruptions. Parameter is relevant only if parameter 21 is set to 0 or 1 (alarm mode).	
<b>Parameter size</b>	1B
<b>Default value</b>	10 (100ms)
<b>Available values</b>	1-100 (10ms-1000ms, 10ms step)
<b>152.</b>	<b>Input 1 - delay of alarm cancellation</b>
This parameter defines additional delay of cancelling the alarm on IN1 input. Parameter is relevant only if parameter 20 is set to 0 or 1 (alarm mode).	
<b>Parameter size</b>	2B
<b>Default value</b>	0 (no delay)
<b>Available values</b>	0 – no delay 1-3600s
<b>153.</b>	<b>Input 2 - delay of alarm cancellation</b>
This parameter defines additional delay of cancelling the alarm on IN2 input. Parameter is relevant only if parameter 21 is set to 0 or 1 (alarm mode).	
<b>Parameter size</b>	2B
<b>Default value</b>	0 (no delay)
<b>Available values</b>	0 – no delay 0-3600s

<b>154.</b>	<b>Output 1 - logic of operation</b>
This parameter defines logic of OUT1 output operation.	
<b>Parameter size</b>	1B
<b>Default value</b>	0 (NO)
<b>Available values</b>	0 – contacts normally open / closed when active 1 – contacts normally closed / open when active
<b>155.</b>	<b>Output 2 - logic of operation</b>
This parameter defines logic of OUT2 output operation.	
<b>Parameter size</b>	1B
<b>Default value</b>	0 (NO)
<b>Available values</b>	0 – contacts normally open / closed when active 1 – contacts normally closed / open when active
<b>156.</b>	<b>Output 1 - auto off</b>
This parameter defines time after which OUT1 will be automatically deactivated.	
<b>Parameter size</b>	2B
<b>Default value</b>	0 (auto off disabled)
<b>Available values</b>	0 – auto off disabled 1-27000 (0.1s-45min, 0.1s step)
<b>157.</b>	<b>Output 2 - auto off</b>
This parameter defines time after which OUT2 will be automatically deactivated.	
<b>Parameter size</b>	2B
<b>Default value</b>	0 (auto off disabled)
<b>Available values</b>	0 – auto off disabled 1-27000 (0.1s-45min, 0.1s step)
<b>63.</b>	<b>Analog inputs - minimal change to report</b>
This parameter defines minimal change (from the last reported) of analog input value that results in sending new report. Parameter is relevant only for analog inputs (parameter 20 or 21 set to 4 or 5). Setting too high value may result in no reports being sent.	
<b>Parameter size</b>	1B
<b>Default value</b>	5 (0.5V)
<b>Available values</b>	0 - reporting on change disabled 1-100 (0.1-10V, 0.1V step)

<b>64.</b>	<b>Analog inputs - periodical reports</b>
This parameter defines reporting period of analog inputs value. Periodical reports are independent from changes in value (parameter 63). Parameter is relevant only for analog inputs (parameter 20 or 21 set to 4 or 5).	
<b>Parameter size</b>	2B
<b>Default value</b>	0 (periodical reports disabled)
<b>Available values</b>	0 – periodical reports disabled 60-32400 (60s-9h)
<b>65.</b>	<b>Internal temperature sensor - minimal change to report</b>
This parameter defines minimal change (from the last reported) of internal temperature sensor value that results in sending new report.	
<b>Parameter size</b>	2B
<b>Default value</b>	5 (0.5°C)
<b>Available values</b>	0 - reporting on change disabled 1-255 (0.1-25.5°C)
<b>66.</b>	<b>Internal temperature sensor - periodical reports</b>
This parameter defines reporting period of internal temperature sensor value. Periodical reports are independent from changes in value (parameter 65).	
<b>Parameter size</b>	2B
<b>Default value</b>	0 (periodical reports disabled)
<b>Available values</b>	0 – periodical reports disabled 60-32400 (60s-9h)
<b>67.</b>	<b>External sensors - minimal change to report</b>
This parameter defines minimal change (from the last reported) of external sensors values (DS18B20 or DHT22) that results in sending new report. Parameter is relevant only for connected DS18B20 or DHT22 sensors.	
<b>Parameter size</b>	2B
<b>Default value</b>	5 (0.5 units)
<b>Available values</b>	0 - reporting on change disabled 1-255 (0.1-25.5 units, 0.1)

<b>68.</b>	<b>External sensors - periodical reports</b>
<p>This parameter defines reporting period of analog inputs value. Periodical reports are independent from changes in value (parameter 67). Parameter is relevant only for connected DS18B20 or DHT22 sensors.</p>	
<b>Parameter size</b>	2B
<b>Default value</b>	0 (periodical reports disabled)
<b>Available values</b>	0 – periodical reports disabled 60-32400 (60s-9h)

## 11: Z-Wave specification

### Supported Command Classes:

	Command Class	Version	Secure
1.	COMMAND_CLASS_ZWAVEPLUS_INFO [0x5E]	V2	
2.	COMMAND_CLASS_SWITCH_BINARY [0x25]	V1	YES
3.	COMMAND_CLASS_ASSOCIATION [0x85]	V2	YES
4.	COMMAND_CLASS_MULTI_CHANNEL_ASSOCIATION [0x8E]	V3	YES
5.	COMMAND_CLASS_ASSOCIATION_GRP_INFO [0x59]	V2	YES
6.	COMMAND_CLASS_TRANSPORT_SERVICE [0x55]	V2	
7.	COMMAND_CLASS_VERSION [0x86]	V2	YES
8.	COMMAND_CLASS_MANUFACTURER_SPECIFIC [0x72]	V2	YES
9.	COMMAND_CLASS_DEVICE_RESET_LOCALLY [0x5A]	V1	YES
10.	COMMAND_CLASS_POWERLEVEL [0x73]	V1	YES
11.	COMMAND_CLASS_SECURITY [0x98]	V1	
12.	COMMAND_CLASS_SECURITY_2 [0x9F]	V1	
13.	COMMAND_CLASS_CENTRAL_SCENE [0x5B]	V3	YES
14.	COMMAND_CLASS_SENSOR_MULTILEVEL [0x31]	V11	YES
15.	COMMAND_CLASS_MULTI_CHANNEL [0x60]	V4	YES
16.	COMMAND_CLASS_CONFIGURATION [0x70]	V1	YES
17.	COMMAND_CLASS_CRC_16_ENCAP [0x56]	V1	
18.	COMMAND_CLASS_NOTIFICATION [0x71]	V8	YES
19.	COMMAND_CLASS_PROTECTION [0x75]	V2	YES
20.	COMMAND_CLASS_FIRMWARE_UPDATE_MD [0x7A]	V4	YES
21.	COMMAND_CLASS_SUPERVISION [0x6C]	V1	
22.	COMMAND_CLASS_APPLICATION_STATUS [0x22]	V1	
23.	COMMAND_CLASS_BASIC [0x20]	V1	YES

**Multichannel Command Class:**

<b>MULTICHANNEL CC</b>	
<b>ROOT (Endpoint 1)</b>	
<b>Generic Device Class</b>	GENERIC_TYPE_SENSOR_NOTIFICATION
<b>Specific Device Class</b>	SPECIFIC_TYPE_NOTIFICATION_SENSOR
<b>Command Classes</b>	COMMAND_CLASS_ZWAVEPLUS_INFO [0x5E]
	COMMAND_CLASS_ASSOCIATION [0x85]
	COMMAND_CLASS_MULTI_CHANNEL_ASSOCIATION [0x8E]
	COMMAND_CLASS_ASSOCIATION_GRP_INFO [0x59]
	COMMAND_CLASS_NOTIFICATION [0x71]
	COMMAND_CLASS_SUPERVISION [0x6C]
	COMMAND_CLASS_APPLICATION_STATUS [0x22]
	COMMAND_CLASS_SECURITY [0x98]
COMMAND_CLASS_SECURITY_2 [0x9F]	
<b>Description</b>	Input 1 - Notification
<b>Endpoint 2</b>	
<b>Generic Device Class</b>	GENERIC_TYPE_SENSOR_NOTIFICATION
<b>Specific Device Class</b>	SPECIFIC_TYPE_NOTIFICATION_SENSOR
<b>Command Classes</b>	COMMAND_CLASS_ZWAVEPLUS_INFO [0x5E]
	COMMAND_CLASS_ASSOCIATION [0x85]
	COMMAND_CLASS_MULTI_CHANNEL_ASSOCIATION [0x8E]
	COMMAND_CLASS_ASSOCIATION_GRP_INFO [0x59]
	COMMAND_CLASS_NOTIFICATION [0x71]
	COMMAND_CLASS_SUPERVISION [0x6C]
	COMMAND_CLASS_APPLICATION_STATUS [0x22]
	COMMAND_CLASS_SECURITY [0x98]
COMMAND_CLASS_SECURITY_2 [0x9F]	
<b>Description</b>	Input 2 - Notification

<b>Endpoint 3</b>	
<b>Generic Device Class</b>	GENERIC_TYPE_SENSOR_MULTILEVEL
<b>Specific Device Class</b>	SPECIFIC_TYPE_ROUTING_SENSOR_MULTILEVEL
<b>Command Classes</b>	COMMAND_CLASS_ZWAVEPLUS_INFO [0x5E]
	COMMAND_CLASS_ASSOCIATION [0x85]
	COMMAND_CLASS_MULTI_CHANNEL_ASSOCIATION [0x8E]
	COMMAND_CLASS_ASSOCIATION_GRP_INFO [0x59]
	COMMAND_CLASS_SENSOR_MULTILEVEL [0x31]
	COMMAND_CLASS_SUPERVISION [0x6C]
	COMMAND_CLASS_APPLICATION_STATUS [0x22]
	COMMAND_CLASS_SECURITY [0x98]
	COMMAND_CLASS_SECURITY_2 [0x9F]
<b>Description</b>	Analog Input 1 - Voltage Level
<b>Endpoint 4</b>	
<b>Generic Device Class</b>	GENERIC_TYPE_SENSOR_MULTILEVEL
<b>Specific Device Class</b>	SPECIFIC_TYPE_ROUTING_SENSOR_MULTILEVEL
<b>Command Classes</b>	COMMAND_CLASS_ZWAVEPLUS_INFO [0x5E]
	COMMAND_CLASS_ASSOCIATION [0x85]
	COMMAND_CLASS_MULTI_CHANNEL_ASSOCIATION [0x8E]
	COMMAND_CLASS_ASSOCIATION_GRP_INFO [0x59]
	COMMAND_CLASS_SENSOR_MULTILEVEL [0x31]
	COMMAND_CLASS_SUPERVISION [0x6C]
	COMMAND_CLASS_APPLICATION_STATUS [0x22]
	COMMAND_CLASS_SECURITY [0x98]
	COMMAND_CLASS_SECURITY_2 [0x9F]
<b>Description</b>	Analog Input 2 - Voltage Level

<b>Endpoint 5</b>	
<b>Generic Device Class</b>	GENERIC_TYPE_SWITCH_BINARY
<b>Specific Device Class</b>	SPECIFIC_TYPE_POWER_SWITCH_BINARY
<b>Command Classes</b>	COMMAND_CLASS_ZWAVEPLUS_INFO [0x5E]
	COMMAND_CLASS_SWITCH_BINARY [0x25]
	COMMAND_CLASS_ASSOCIATION [0x85]
	COMMAND_CLASS_MULTI_CHANNEL_ASSOCIATION [0x8E]
	COMMAND_CLASS_ASSOCIATION_GRP_INFO [0x59]
	COMMAND_CLASS_PROTECTION [0x75]
	COMMAND_CLASS_SUPERVISION [0x6C]
	COMMAND_CLASS_APPLICATION_STATUS [0x22]
	COMMAND_CLASS_SECURITY [0x98]
COMMAND_CLASS_SECURITY_2 [0x9F]	
<b>Description</b>	Output 1
<b>Endpoint 6</b>	
<b>Generic Device Class</b>	GENERIC_TYPE_SWITCH_BINARY
<b>Specific Device Class</b>	SPECIFIC_TYPE_POWER_SWITCH_BINARY
<b>Command Classes</b>	COMMAND_CLASS_ZWAVEPLUS_INFO [0x5E]
	COMMAND_CLASS_SWITCH_BINARY [0x25]
	COMMAND_CLASS_ASSOCIATION [0x85]
	COMMAND_CLASS_MULTI_CHANNEL_ASSOCIATION [0x8E]
	COMMAND_CLASS_ASSOCIATION_GRP_INFO [0x59]
	COMMAND_CLASS_PROTECTION [0x75]
	COMMAND_CLASS_SUPERVISION [0x6C]
	COMMAND_CLASS_APPLICATION_STATUS [0x22]
	COMMAND_CLASS_SECURITY [0x98]
COMMAND_CLASS_SECURITY_2 [0x9F]	
<b>Description</b>	Output 2



<b>Endpoint 7</b>	
<b>Generic Device Class</b>	GENERIC_TYPE_SENSOR_MULTILEVEL
<b>Specific Device Class</b>	SPECIFIC_TYPE_ROUTING_SENSOR_MULTILEVEL
<b>Command Classes</b>	COMMAND_CLASS_ZWAVEPLUS_INFO [0x5E]
	COMMAND_CLASS_ASSOCIATION [0x85]
	COMMAND_CLASS_MULTI_CHANNEL_ASSOCIATION [0x8E]
	COMMAND_CLASS_ASSOCIATION_GRP_INFO [0x59]
	COMMAND_CLASS_NOTIFICATION [0x71]
	COMMAND_CLASS_SENSOR_MULTILEVEL [0x31]
	COMMAND_CLASS_SUPERVISION [0x6C]
	COMMAND_CLASS_APPLICATION_STATUS [0x22]
	COMMAND_CLASS_SECURITY [0x98]
	COMMAND_CLASS_SECURITY_2 [0x9F]
<b>Description</b>	Temperature - internal sensor
<b>Endpoint 8-13 (when DS18S20 sensors connected)</b>	
<b>Generic Device Class</b>	GENERIC_TYPE_SENSOR_MULTILEVEL
<b>Specific Device Class</b>	SPECIFIC_TYPE_ROUTING_SENSOR_MULTILEVEL
<b>Command Classes</b>	COMMAND_CLASS_ZWAVEPLUS_INFO [0x5E]
	COMMAND_CLASS_ASSOCIATION [0x85]
	COMMAND_CLASS_MULTI_CHANNEL_ASSOCIATION [0x8E]
	COMMAND_CLASS_ASSOCIATION_GRP_INFO [0x59]
	COMMAND_CLASS_NOTIFICATION [0x71]
	COMMAND_CLASS_SENSOR_MULTILEVEL [0x31]
	COMMAND_CLASS_SUPERVISION [0x6C]
	COMMAND_CLASS_APPLICATION_STATUS [0x22]
	COMMAND_CLASS_SECURITY [0x98]
	COMMAND_CLASS_SECURITY_2 [0x9F]
<b>Description</b>	Temperature - external sensor DS18B20 No 1-6

<b>Endpoint 8 (when DHT22 sensor connected)</b>	
<b>Generic Device Class</b>	GENERIC_TYPE_SENSOR_MULTILEVEL
<b>Specific Device Class</b>	SPECIFIC_TYPE_ROUTING_SENSOR_MULTILEVEL
<b>Command Classes</b>	COMMAND_CLASS_ZWAVEPLUS_INFO [0x5E]
	COMMAND_CLASS_ASSOCIATION [0x85]
	COMMAND_CLASS_MULTI_CHANNEL_ASSOCIATION [0x8E]
	COMMAND_CLASS_ASSOCIATION_GRP_INFO [0x59]
	COMMAND_CLASS_NOTIFICATION [0x71]
	COMMAND_CLASS_SENSOR_MULTILEVEL [0x31]
	COMMAND_CLASS_SUPERVISION [0x6C]
	COMMAND_CLASS_APPLICATION_STATUS [0x22]
	COMMAND_CLASS_SECURITY [0x98]
	COMMAND_CLASS_SECURITY_2 [0x9F]
<b>Description</b>	Temperature - external sensor DHT22
<b>Endpoint 9 (when DHT22 sensor connected)</b>	
<b>Generic Device Class</b>	GENERIC_TYPE_SENSOR_MULTILEVEL
<b>Specific Device Class</b>	SPECIFIC_TYPE_ROUTING_SENSOR_MULTILEVEL
<b>Command Classes</b>	COMMAND_CLASS_ZWAVEPLUS_INFO [0x5E]
	COMMAND_CLASS_ASSOCIATION [0x85]
	COMMAND_CLASS_MULTI_CHANNEL_ASSOCIATION [0x8E]
	COMMAND_CLASS_ASSOCIATION_GRP_INFO [0x59]
	COMMAND_CLASS_NOTIFICATION [0x71]
	COMMAND_CLASS_SENSOR_MULTILEVEL [0x31]
	COMMAND_CLASS_SUPERVISION [0x6C]
	COMMAND_CLASS_APPLICATION_STATUS [0x22]
	COMMAND_CLASS_SECURITY [0x98]
	COMMAND_CLASS_SECURITY_2 [0x9F]
<b>Description</b>	Humidity - external sensor DHT22

### Notification Command Class:

The device uses Notification Command Class to report different events to the controller (“Lifeline” group).

ROOT (Endpoint 1)		
Notification Type	Event	
Home Security [0x07]	Intrusion Unknown Location [0x02]	
Endpoint 2		
Notification Type	Event	
Home Security [0x07]	Intrusion Unknown Location [0x02]	
Endpoint 7		
Notification Type	Event	Event /State Parameter
System [0x09]	System hardware failure with manufacturer proprietary failure code [0x03]	Device Overheat [0x03]
Endpoint 8-13		
Notification Type	Event	
System [0x09]	System hardware failure [0x01]	

### Protection CC:

Protection Command Class allows to prevent local or remote control of the outputs.

Type	State	Description	Hint
Local	0	Unprotected - The device is not protected, and may be operated normally via the user interface.	Inputs connected with outputs.
Local	2	No operation possible – state of output cannot be changed by the B-button or corresponding Input	Inputs disconnected from outputs.
RF	0	Unprotected - The device accept and respond to all RF Commands.	Outputs can be controlled via Z-Wave.
RF	1	No RF control – command class basic and switch binary are rejected, every other command class will be handled	Outputs cannot be controlled via Z-Wave.

**Association groups mapping:**

Root	Endpoint	Association group in endpoint
Association Group 2	Endpoint 1	Association Group 2
Association Group 3	Endpoint 2	Association Group 2

**Basic commands mapping:**

Command	Root	Endpoints			
		1-2	3-4	5-6	7-13
Basic Set	= EP1	Appli- cation Rejected	Appli- cation Rejected	Switch Bi- nary Set	Appli- cation Rejected
Basic Get	= EP1	Notifica- tion Get	Sensor Multilevel Get	Switch Bi- nary Get	Sensor Multilevel Get
Basic Report	= EP1	Notifi- cation Report	Sensor Multilevel Report	Switch Binary Report	Sensor Multilevel Report

**Other Command Class mappings:**

Command Class	Root mapped to
Sensor Multilevel	Endpoint 7
Binary Switch	Endpoint 5
Protection	Endpoint 5

## 12: Regulations

### **This device complies with Part 15 of the FCC Rules**

Operation is subject to the following two conditions:

1. This device may not cause harmful interference
2. This device must accept any interference received, including interference that may cause undesired operation. This equipment has been tested and found to comply with the limits for a Class B digital device, pursuant to part 15 of the FCC Rules. These limits are designed to provide reasonable protection against harmful interference in a residential installation. This equipment generates, uses and can radiate radio frequency energy and, if not installed and used in accordance with the instructions, may cause harmful interference to radio communications. However, there is no guarantee that interference will not occur in a particular installation. If this equipment does cause harmful interference to radio or television reception, which can be determined by turning the equipment off and on, the user is encouraged to try to correct the interference by one or more of the following measures:

- Reorient or relocate the receiving antenna.
- Increase the separation between the equipment and receiver.
- Connect the equipment into an outlet on a circuit different from that to which the receiver is connected.
- Consult the dealer or an experienced radio/TV technician for help.

Changes and modifications not expressly approved by the manufacturer or registrant of this equipment can void your authority to operate this equipment under Federal Communications Commission's rules.

### **Industry Canada (IC) Compliance Notice**

This device complies with Industry Canada license-exempt RSSs. Operation is subject to the following two conditions: (1) this device may not cause interference, and (2) this device must accept any interference, including interference that may cause undesired operation of the device.

Cet appareil est conforme aux normes d'exemption de licence RSS d'Industry Canada. Son fonctionnement est soumis aux deux conditions suivantes : (1) cet appareil ne doit pas causer d'interférence et (2) cet appareil doit accepter toute interférence, notamment les interférences qui peuvent affecter son fonctionnement.

## Legal Notices

All information, including, but not limited to, information regarding the features, functionality, and/or other product specification are subject to change without notice. Fibaro reserves all rights to revise or update its products, software, or documentation without any obligation to notify any individual or entity.

FIBARO and Fibar Group logo are trademarks of Fibar Group S.A. All other brands and product names referred to herein are trademarks of their respective holders.

## Declaration of conformity

 Hereby, Fibar Group S.A. declares that the device is in compliance with the essential requirements and other relevant provisions of Directive 2014/53/EU. The full text of the EU declaration of conformity is available at the following internet address: [www.manuals.fibaro.com](http://www.manuals.fibaro.com)

## WEEE Directive Compliance

 Device labelled with this symbol should not be disposed with other household wastes. It shall be handed over to the applicable collection point for the recycling of waste electrical and electronic equipment.

