



# qubino®

Your little magic for the smartest home.

USER MANUAL **EN**

---

## QUBINO SMART PLUG 16A



*The Qubino Smart Plug 16A is ideal for remotely controlling electrical devices and measuring the energy consumption.*

# Table of contents

About Qubino.....	4
Safety Information .....	6
Smart Plug 16A - Available Frequencies .....	7
Where To Buy.....	7
1. Introduction .....	8
2. Use Cases .....	10
2.1. Usage examples for Smart Plug 16A – for switching device on/off and measuring power consumption of the connected device .....	10
2.2. Usage examples for Smart Plug 16A – for measuring power consumption of the connected device .....	12
2.3. Additional features of Smart Plug 16A which can make your life easier .....	13
3. Qubino Smart Plug 16A Advantages and Highlights.....	14
3.1. Advantages.....	14
3.2. Highlights .....	17
4. Package Contents.....	18
5. Compatibility with Z-Wave Gateways (hubs) .....	19
6. Installation .....	20
6.1. Installing the device .....	21
7. Device Information and Support .....	24
8. Electrical Diagram 230VAC.....	25
9. Adding the device to a Z-Wave network (Inclusion).....	27
10. Removing the device from a Z-Wave network (Exclusion).....	28
LED (Blue).....	29
LED (Red).....	29
11. Associations .....	30
12. Notification Command Class.....	31
13. Firmware update.....	32

- 14. Configuration Parameters..... 33
- 15. Technical Specifications ..... 40
- 16. Z-Wave Command Classes ..... 41
- 17. Z-Wave Security ..... 42
- 18. Important Disclaimer ..... 43
- 19. Warning..... 43
- 20. Regulations..... 43



**About Z-Wave:**

The Z-Wave protocol is an interoperable, wireless, RF-based communications technology designed specifically for control, monitoring, and status reading applications in residential and light commercial environments. Mature, proven, and broadly deployed (with over 50 million products sold worldwide), Z-Wave is by far the world market leader in wireless control, bringing affordable, reliable, and easy-to-use 'smart' products to millions of people in every aspect of daily life.

Source: [www.z-wavealliance.org](http://www.z-wavealliance.org)

## Safety Information

For Qubino, safety is first, so we have prepared lots of safety tips and information that can be found throughout this manual.

**To ensure your safety, please read this manual carefully before installing the device; follow the instructions exactly.** The manufacturer (GOAP d.o.o. Nova Gorica) shall not be legally responsible for any equipment damage or personal injury caused by incorrect installation or operation other than that covered in this manual.

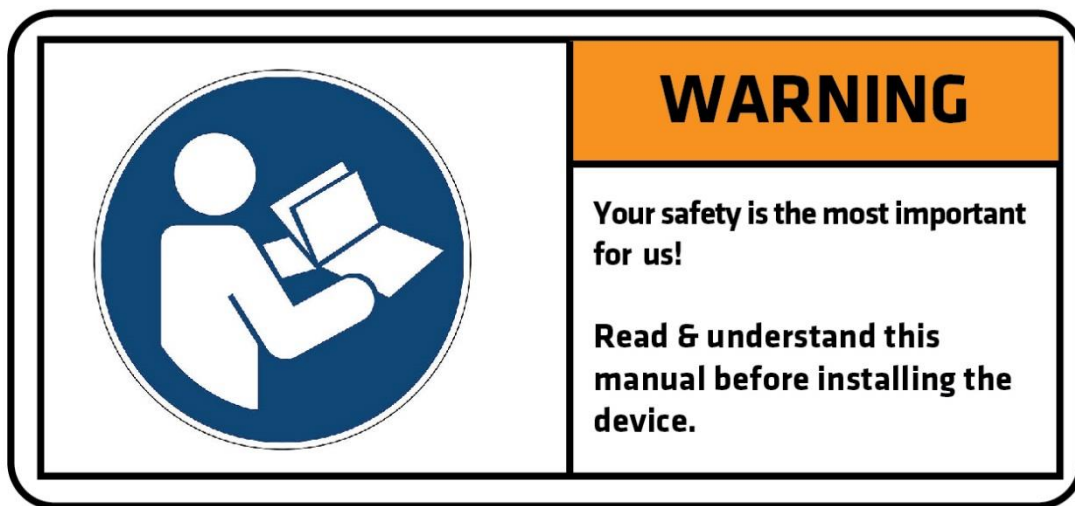

**i** Please check the Technical Specifications and Electrical Diagram chapters, as well as fuse requirements in the Installation chapter before installing the device.

## Smart Plug 16A - Available Frequencies

 **NOTE:** The Smart Plug 16A is compatible only with socket type F.

ORDERING CODE (MODEL NUMBER)	POWER SUPPLY FREQUENCY	Z-WAVE FREQUENCY*
ZMNHYD1	50/60 Hz	868,4 MHz
ZMNHYD4	50/60 Hz	869,0 MHz
ZMNHYDA	50/60 Hz	919,7 – 921,7 – 923,7 MHz
ZMNHYDB	50/60 Hz	868,1 MHz
ZMNHYDE	50/60 Hz	920,9 MHz

\*You can check the Z-Wave frequency in your country here:

[https://z-wave.sigmadesigns.com/wp-content/uploads/Z-Wave\\_Frequency\\_Coverage-.pdf](https://z-wave.sigmadesigns.com/wp-content/uploads/Z-Wave_Frequency_Coverage-.pdf)

# Where To Buy

To find your nearest Qubino dealer visit: <http://qubino.com/where-to-buy/>

## 1. Introduction

The Smart Plug 16A controls on/off function for the connected device. It also measures power consumption of the connected device according to the principle of fast sampling of voltage and current signals. A built-in microprocessor calculates energy and power from the measured signals.

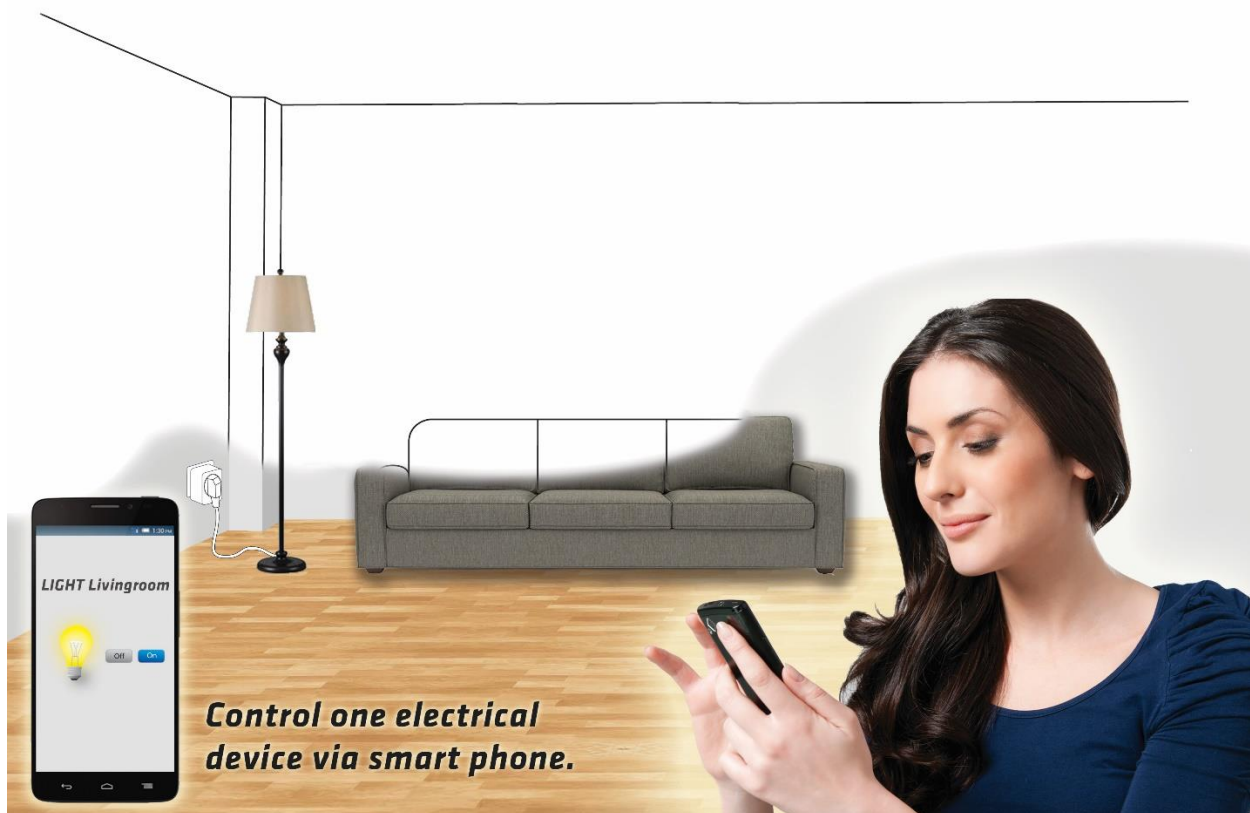

The Qubino Smart Plug 16A also acts as a Z-Wave repeater to improve the range and stability of the Z-Wave network.



**Smart Plug 16A supported functions:**

Turn ON/OFF	W Measurement	kWh Measurement	Current (A) Measurement	Voltage (V) Measurement	Automatically turn ON/OFF	Associations	Z-Wave Repeater	Auto-inclusion
✓	✓	✓	✓	✓	✓	✓	✓	✓

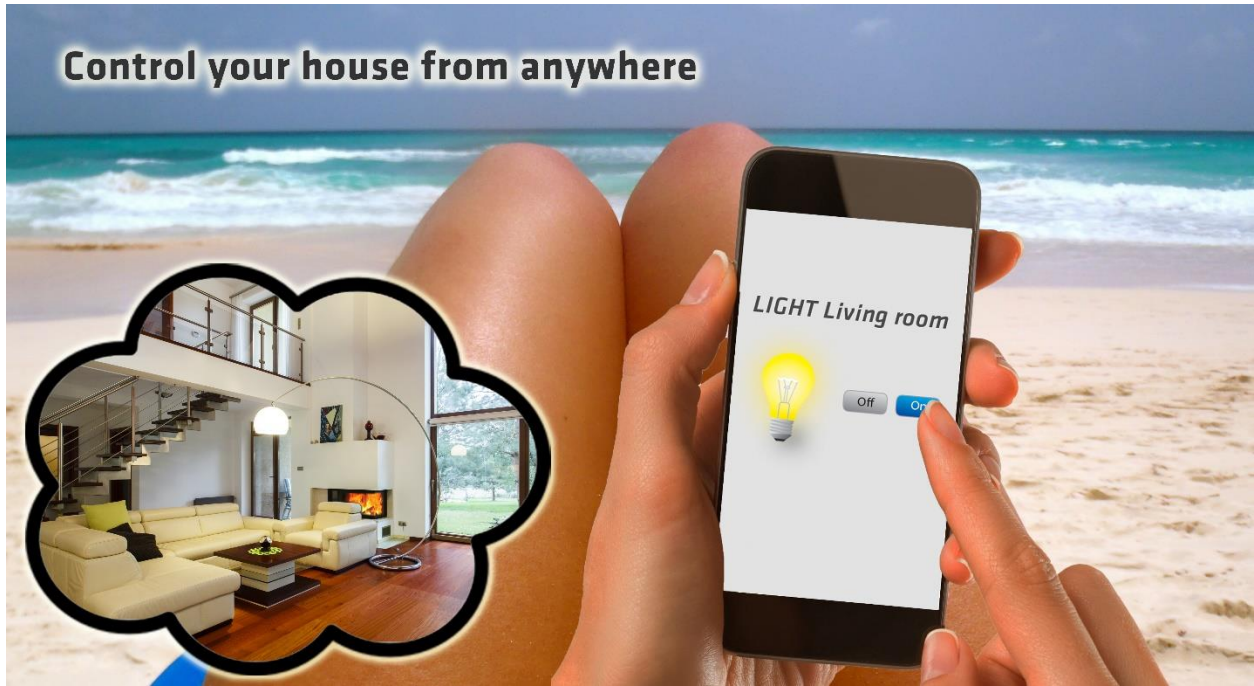

## 2. Use Cases

The Smart Plug 16A can be used in many different scenes, which can help make your life more comfortable. We have prepared a few of them for you-so you can get an idea for your next smart home project. Of course, there are countless of other options for how to use the Qubino Smart Plug 16A to remotely control devices via your smartphone.

### 2.1. Usage examples for Smart Plug 16A – for switching device on/off and measuring power consumption of the connected device

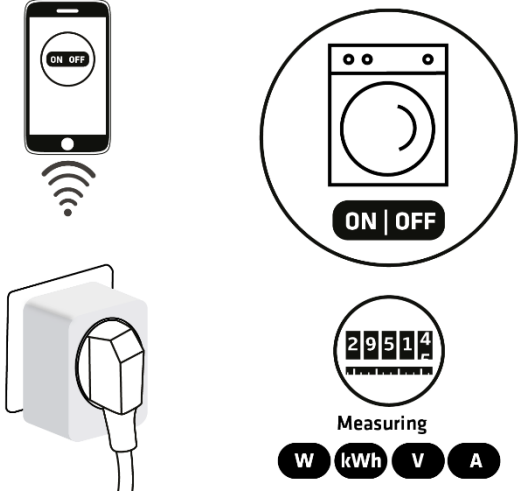
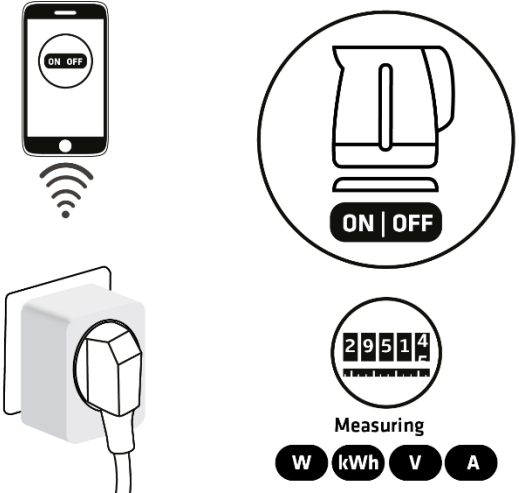
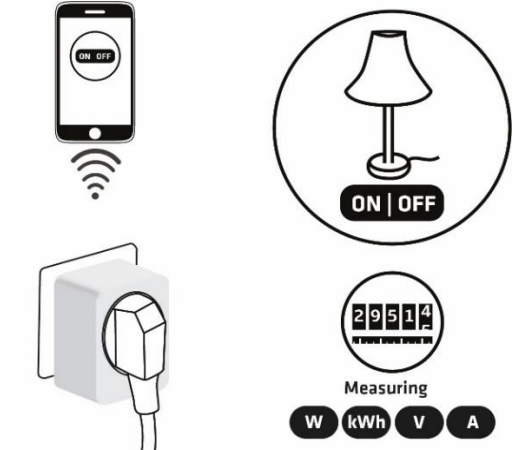
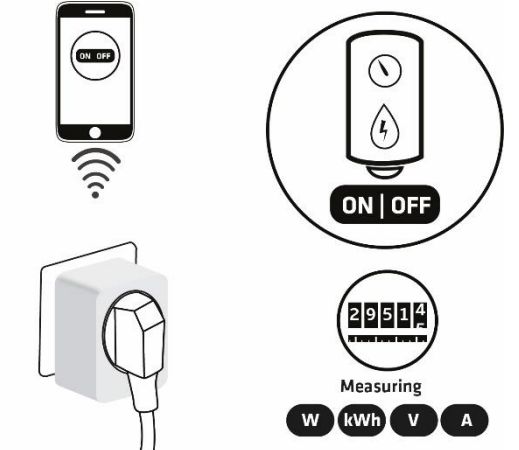
<ul style="list-style-type: none"><li>Remotely control a tumble dryer</li></ul> 	<ul style="list-style-type: none"><li>Remotely control a water heater</li></ul> 
<ul style="list-style-type: none"><li>Remotely control a lamp</li></ul> 	<ul style="list-style-type: none"><li>Remotely control domestic hot water tank</li></ul> 

- Remotely control an oven

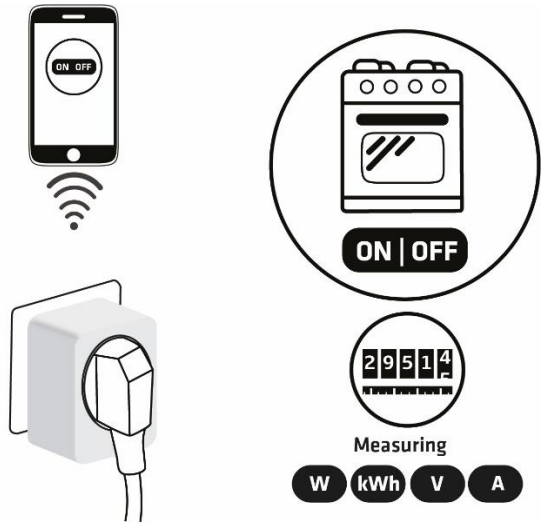

- Remotely control an iron

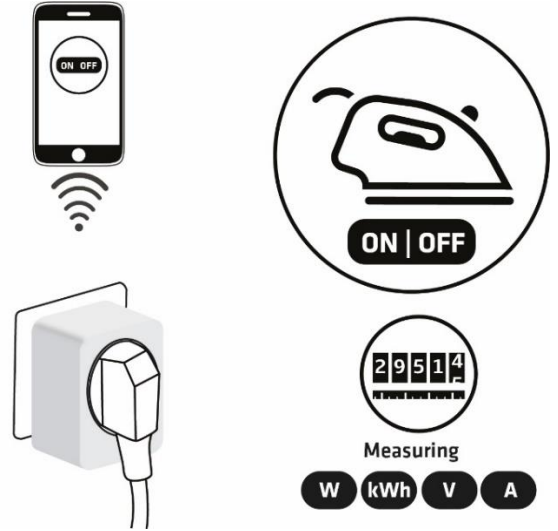

- Remotely control a fan

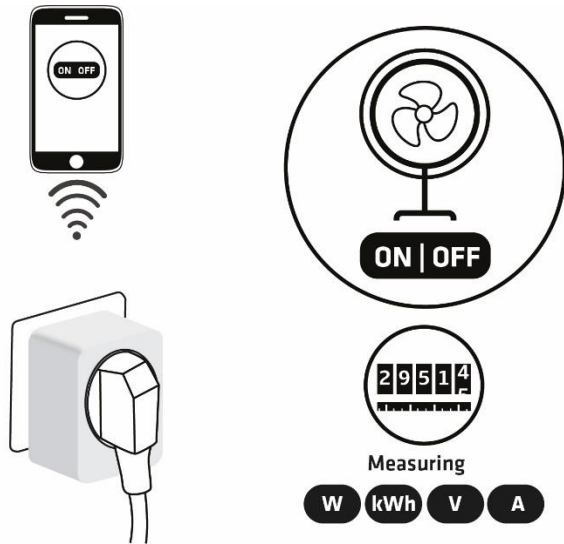

- Remotely control an electric radiator

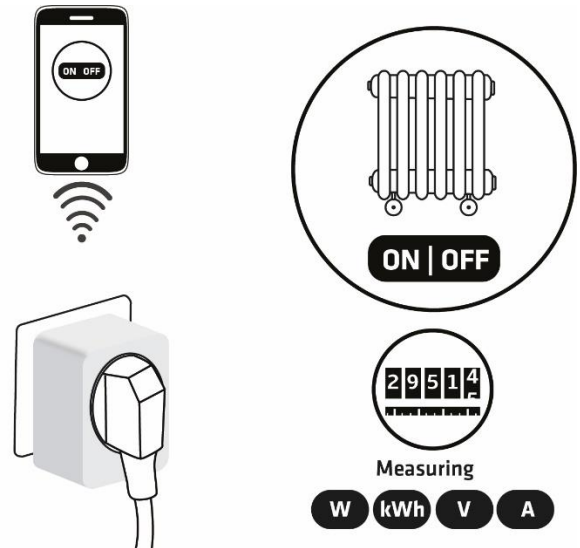

2.2. Usage examples for Smart Plug 16A – for measuring power consumption of the connected device

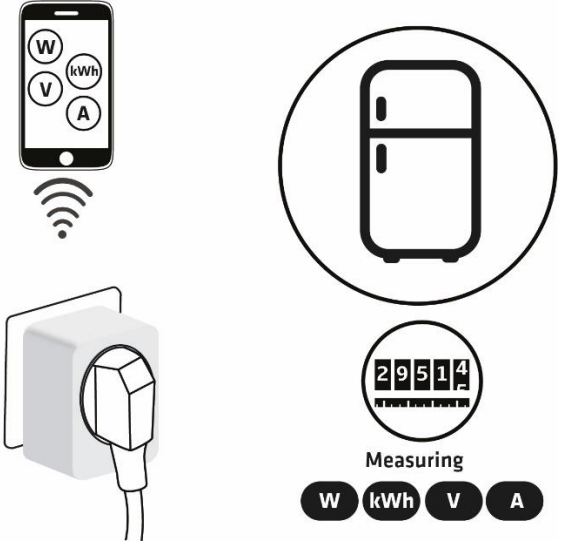
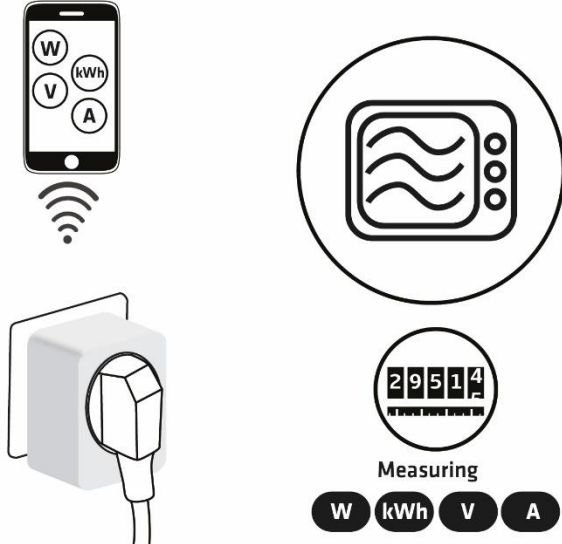
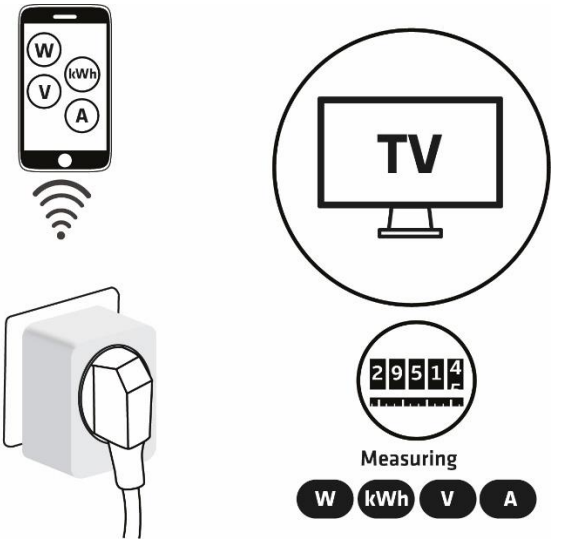
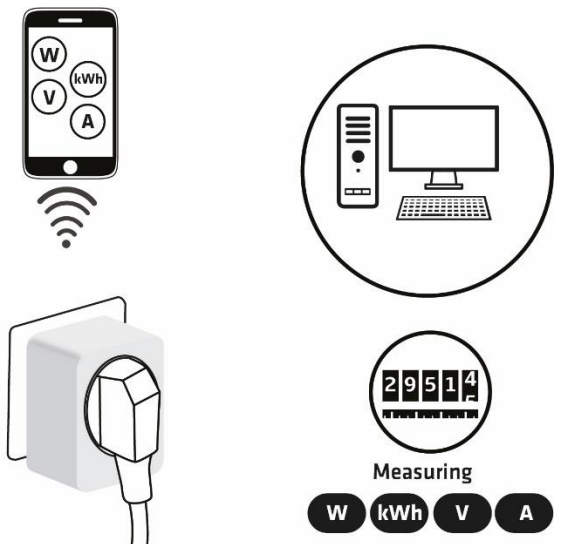
<ul style="list-style-type: none"><li>Remotely measure power consumption of refrigerator</li></ul> 	<ul style="list-style-type: none"><li>Remotely measure power consumption of microwave oven</li></ul> 
<ul style="list-style-type: none"><li>Remotely measure power consumption of television</li></ul> 	<ul style="list-style-type: none"><li>Remotely measure power consumption of computer connected to a power socket</li></ul> 

### 2.3. Additional features of Smart Plug 16A which can make your life easier

- **Do you often forget to turn off devices when you leave your home, like lights in the basement or attic?**
- The Smart Plug 16A can automatically turn devices/lights on or off after a set period (when you're away from home). For example, the light will automatically turn off if it's been on for 8 hours, let's say. This function is independent of other scenes and gateway (hub) commands.

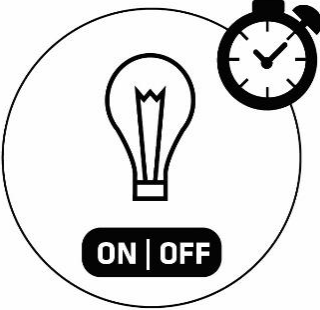

- **Do you know how much energy you consume?**
- The Smart Plug 16A monitors and reports energy consumption of connected devices in real time to your smart home app (your gateway (hub) needs to support this feature). Know how much power your light, domestic water tank, iron, etc, is using.

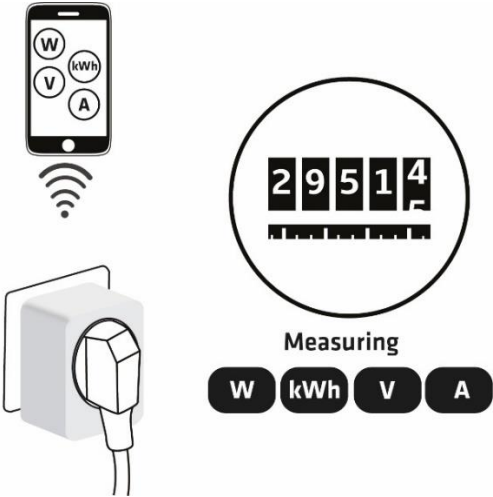

- **Want to control other devices in your Z-Wave network with the Smart Plug 16A?**
- Connect the Smart Plug 16A with other devices in your network to remotely and automatically trigger another Z-Wave device. And have other Z-Wave devices trigger your Qubino Smart Plug 16A.



## 3. Qubino Smart Plug 16A Advantages and Highlights

### 3.1. Advantages

- The Qubino Smart Plug 16A is the only Smart Plug that **supports S2** Authenticated security.



- The Qubino Smart Plug 16A allows the **easiest and quickest installation possible**: It is plug&play device which means that no installation skills are needed for the device set up. The device fits into any schuko power socket.

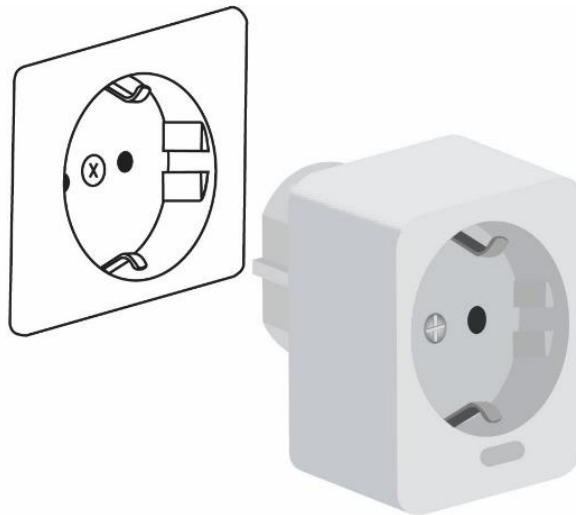

- The Qubino Smart Plug 16A allows the possibility to manage all appliances in your apartment. You will not be limited to use it only on the small energy consumers. You can plug in appliances with higher consumption, up to 3680W, such as water heater, iron, hot water tank, electric oven, electric heater, tumble dryer. This is possible because Qubino Smart Plug 16A is the smallest Z-Wave smart plug in the world that supports 16A current.

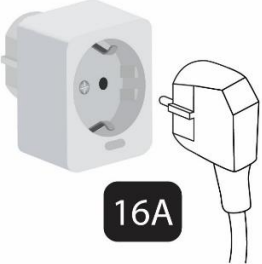

16A

3680W



2000-2200W



2200-3000W

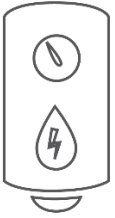

2000W



2500W

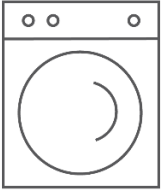

3000W

- The Qubino Smart Plug 16A is one of the smallest smart plugs among competitors - it **doesn't overlap the socket on the power board** or if the power sockets are placed next to each other. This means that the other sockets are still functional, you can use them to plug in something else.
- Qubino guarantees **100% device quality**. Such high quality can be delivered because every Qubino goes through rigorous quality control standards throughout the production process. Every device has a unique serial number and a part number, which are assigned to the device only after it goes through a strict testing procedure.

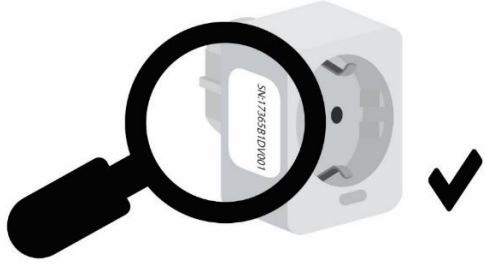



- By scanning the QR code on the back of your Qubino device, the serial and part numbers will be automatically copied on your mobile phone; they also provide **direct access to Qubino’s technical support team**. The serial and part numbers of your device are given automatically every time you open an inquiry with our support team: this instantly shares the relevant device information we need to provide the best technical support possible. For details, please see the Device Information and Support chapter.



- The Qubino Smart Plug 16A is certified by an independent Institute and has LVD and EMC certificates to ensure the highest safety standards.

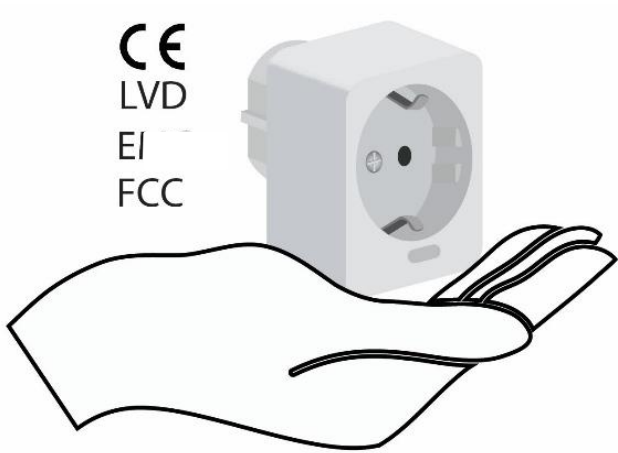



### 3.2. Highlights

- Remote (via smartphone or PC) and local on/off control of bulbs and electrical appliances such as irons, microwave, fans etc.
- Capable of measuring the power consumption of the connected device in real time via smartphone, which allows you to save on electricity bills\*
- Features one of the easiest and quickest installations of devices
- Saves and restores the last status after a power failure
- Supports auto-inclusion mode for quick set up
- Can be set up anywhere in the house and moved freely, so you can put it in any room you like
- Can automatically turn devices on and off after a set period of time (helpful when you're away from home, for example) \*
- Supports additional parameters for expert users, which allows for advanced configuration\*
- Acts as a signal repeater which improves the range and stability of your Z-Wave network
- Can be used to remotely control and trigger other devices in your Z-Wave network

\*Your gateway (hub) needs to support advanced configuration and parameter input if you wish to use this feature

## 4. Package Contents

- Smart Plug 16A Device
- Installation Manual
- S2 packaging label

## 5. Compatibility with Z-Wave Gateways (hubs)

Please check compatibility with your Z-Wave gateway (hub) before you purchase this device. The compatibility table is in preparation, for any information, please contact us at: <http://qubino.com/support/#email>.

## 6. Installation

**Before installing the device, please read the following carefully and follow the instructions exactly:**

**ⓘ Note!**

Do not connect the device to loads exceeding the recommended values. Connect the device exactly as shown in the provided diagrams. Improper use may be dangerous and result in equipment damage.

Electrical installation must be protected by directly associated overcurrent protection fuse with rated current up to 16A.

## 6.1. Installing the device

The installation consists of the following simple steps:

### **Step 1 – Enable inclusion mode on your gateway (hub)**



**Step 2 – Insert the Smart Plug 16A device into the socket – the device will be automatically added in your z-wave network**

STEP 2

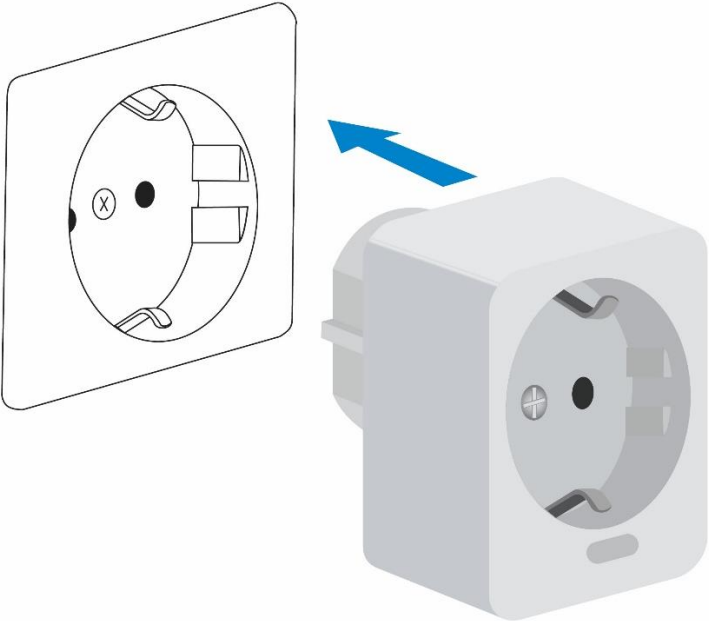

**Step 3 – Connect the desired load (electrical device) with the Smart Plug 16A**

STEP 3

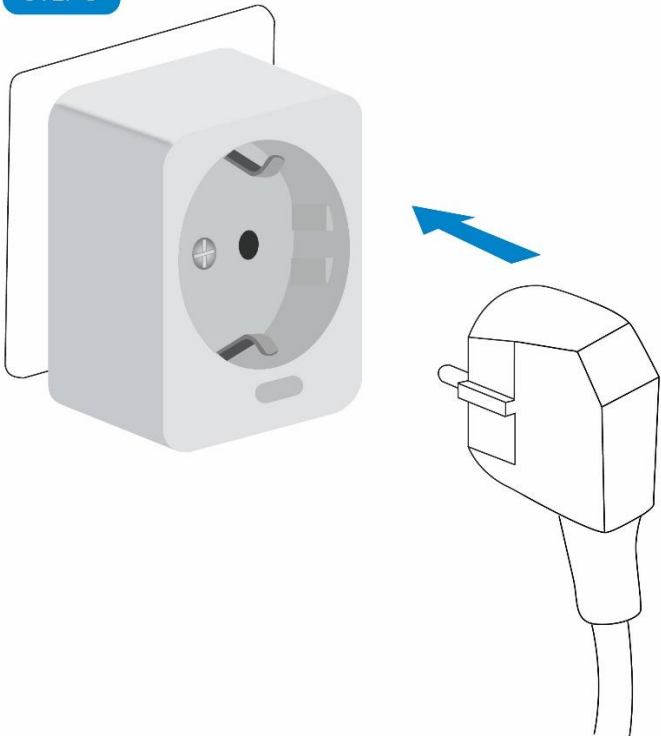

**Step 4 – The Installation is now complete. It’s time to make your life more comfortable with the help of the Qubino Smart Plug**

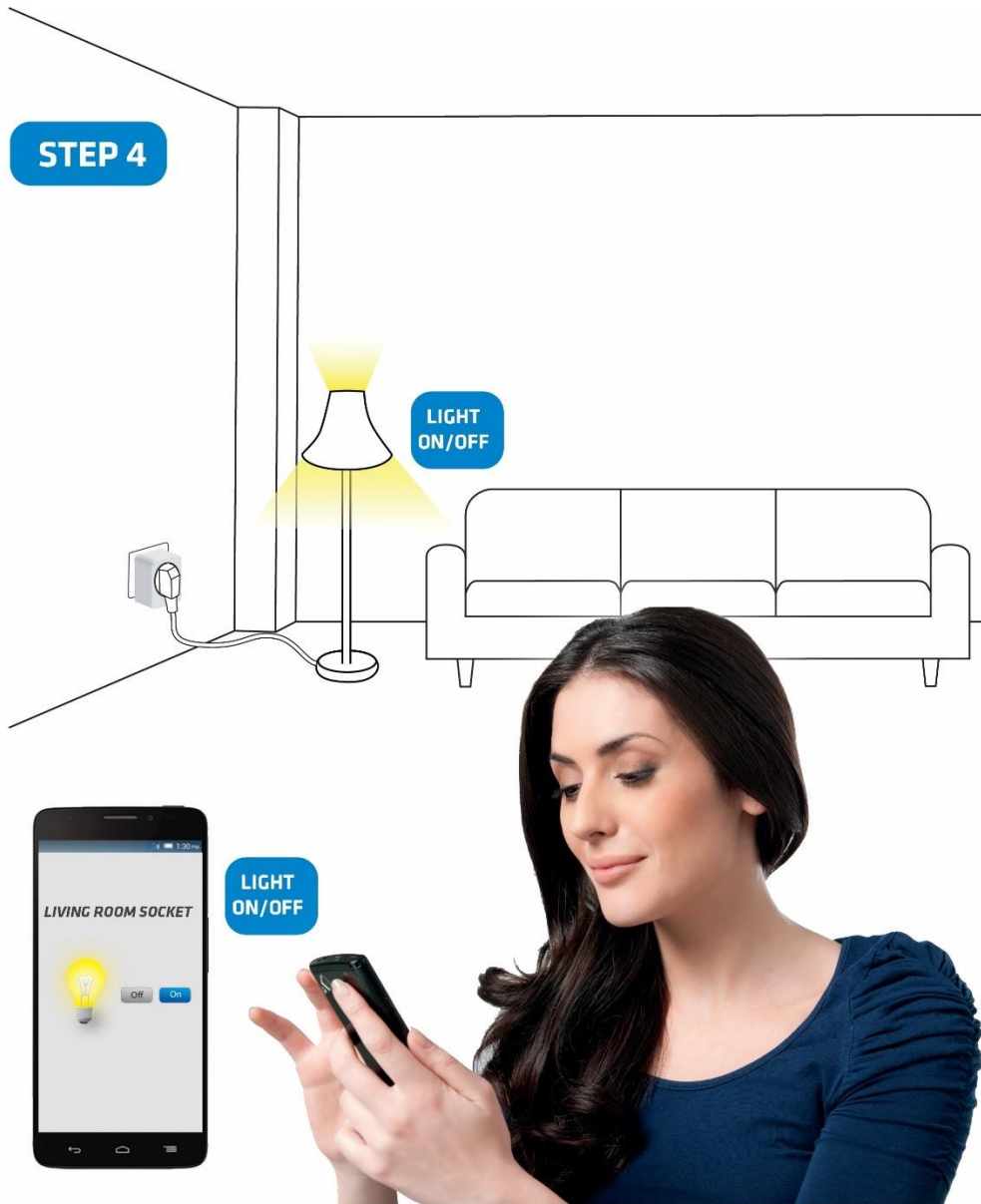

# 7. Device Information and Support

Did you know that Qubino offers Z-Wave devices with 100% quality control guaranteed throughout the production process? Every single unit is tested and examined before being approved for sale – a truly unique pledge in the industry.

### Why is this important?

Every device has a dedicated serial number and part number, which is assigned to the device only after it goes through a strict testing procedure.

By scanning the QR code on the side of your Qubino, its device title, serial number, and part number are automatically copied to your mobile phone. You can also use the code for direct access to the device page for more information. If you still don't find what you're looking for, click on the link to Qubino technical support team. They will be able to automatically read the serial and part number from your device and quickly review the production log file containing the production date as well as any relevant device parameters and information. This process allows our team to immediately identify and address issues, giving you the best support possible.

### GET SUPPORT IN 3 SIMPLE STEPS:



Based on customer and business partner feedback, we're proud to boast Qubino's support team as the best and fastest on the market. If you don't find the answers to your questions in this document, please contact our support team by scanning the QR code on your device or through our website: <http://qubino.com/support/#email>. We will try to help you as soon as possible.



## 8. Electrical Diagram 230VAC

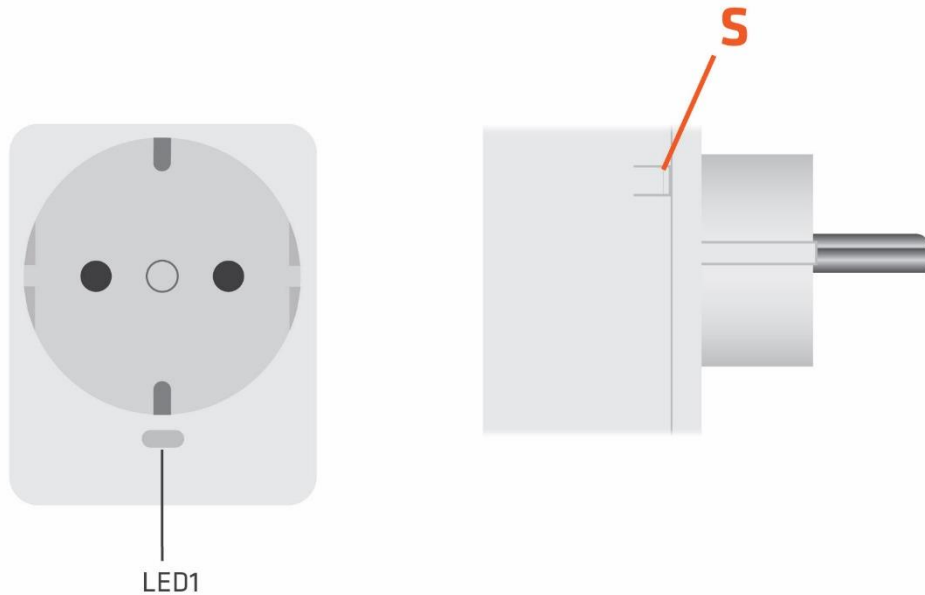

### Notes for diagram:

<b>S</b>	Service button (used to add or remove the Smart Plug 16A from the Z-Wave network and for turning the internal relay ON/OFF)
<b>LED</b>	<p><b>When the Smart Plug 16A is excluded:</b></p> <p><b>When the relay is turned OFF:</b></p> <ul style="list-style-type: none"> <li>• blue LED is blinking (1 sec ON, 1 sec OFF)</li> </ul> <p><b>When the relay is turned ON:</b></p> <ul style="list-style-type: none"> <li>• blue LED is ON</li> <li>• red LED is blinking (0.3 sec ON, 0.3 sec OFF) when the current exceeds 14,4A</li> <li>• red LED is ON after the overload or overcurrent occurred</li> </ul> <p><b>When the Smart Plug 16A is included:</b></p> <p><b>When the relay is turned OFF:</b></p> <ul style="list-style-type: none"> <li>• LED is OFF</li> </ul> <p><b>When the relay is turned ON:</b></p> <ul style="list-style-type: none"> <li>• blue LED is ON</li> <li>• red LED is blinking (0.3 sec ON, 0.3 sec OFF) when the current exceeds 14,4A</li> <li>• red LED is ON after the overload or overcurrent occurred</li> </ul>

**MEASUREMENTS:**

<b>V</b>	Voltage
<b>A</b>	Current
<b>W</b>	Power – Active
<b>kWh</b>	Energy – Active power accumulated

**WARNINGS:****Overcurrent protection**

When load is for 5 sec over 16.1A, relay is automatically turned off, red LED turns on and “Overcurrent detected” notification is sent.

To reactivate the device, it has to be pulled out of the power socket and put in again.

NOTE: The overcurrent protection is always active and cannot be disabled.

**Overcurrent warning**

When load is near overcurrent state (over 14.4 A), Unsolicited Meter Report is sent and the red LED starts blinking. When the current returns below 14.4 A, the blue LED goes back to normal operation.

**Under/over voltage**

When module detects a 10% voltage rise/drop from the 230V a “Under/over voltage detected” notification is sent.

**Overload**

The user has an option with parameter 70 to set an overload threshold. If the threshold is set and the power exceeds it for 3 seconds the Smart plug will turn off, the red LED will be on and a “Overload detected” notification is sent.

**Watchdog**

To protect the Smart Plug against getting stuck in an undesired state, the watchdog timer is enabled.

## 9. Adding the device to a Z-Wave network (Inclusion)

### **AUTOMATICALLY ADDING THE DEVICE TO A Z-WAVE NETWORK (AUTO INCLUSION)**

1. Enable add/remove mode on your Z-Wave gateway (hub)
2. Automatic selection of secure/unsecure inclusion
3. The device can be automatically added to a Z-Wave network during the first 2 minutes
4. Connect the device to the power supply
5. Auto-inclusion will be initiated within 5 seconds of connection to the power supply and the device will automatically enrol in your network (when the device is excluded and connected to the power supply it automatically enters the INCLUSION MODE state.)

① NOTE: INCLUSION MODE state allows the device to receive network information from the controller

① NOTE: For S2 inclusion please check chapter – »17. Z-Wave Security«.

### **MANUALLY ADDING THE DEVICE TO A Z-WAVE NETWORK (MANUAL INCLUSION)**

1. Connect the device to the power supply
2. Enable add/remove mode on your Z-Wave gateway (hub)
3. Press and hold the Service button S from 2 to 6 seconds (with holding the S button for the interval between 2 and 6 seconds you put the device in INCLUSION MODE)
4. A new device will appear on your dashboard

① NOTE: INCLUSION MODE STATE allows the device to receive network information from the controller

## 10. Removing the device from a Z-Wave network (Exclusion)

### REMOVAL FROM A Z-WAVE NETWORK (Z-WAVE EXCLUSION)

1. Connect the device to the power supply
2. Make sure the device is within direct range of your Z-Wave gateway (hub) or use a hand-held Z-Wave remote to perform exclusion
3. Enable add/remove mode on your Z-Wave gateway (hub)
4. Press and hold the Service button S from 2 to 6 seconds (with holding the S button for the interval between 2 and 6 seconds you put the device in EXCLUSION MODE)
5. The device will be removed from your network, but any custom configuration parameters will not be erased

① NOTE: EXCLUSION MODE state allows the device to receive network information from the controller

### FACTORY RESET

- The reset is only possible the first minute after the power on
- Press and hold the service button S more than 6 seconds
- The device will be removed from your network and the led will start blinking. The device is now in its factory default state.
- When the S button is held more than 6 seconds after the first minute is passed, the relay should not react!

① By resetting the device, all custom parameters previously set on the device will return to their default values, and the owner ID will be deleted. Use this reset procedure only when the main gateway (hub) is missing or otherwise inoperable.

**NOTE: After the device is removed or RESET, wait at least 30 seconds before disconnecting the device from the power supply.**

## **LED SIGNALIZATION FOR INCLUSION/EXCLUSION**

### **LED (Blue)**

- When relay is ON, LED is always ON (if no overcurrent/overload)
- When relay is OFF, LED is 1s OFF, 1s ON = module is excluded
- When relay is OFF, LED is OFF = module is included
- After reset (and relay if OFF) LED is 1s OFF, 1s ON = module is excluded

### **LED (Red)**

- If current exceeds 14.4A LED is 0.3s OFF, 0.3s ON
- If overcurrent/overload occurs LED is ON

## **OPERATION**

Internal relay can be switched on/off with:

- Pushing the service button S (press)
- Sending a Basic set command
- Sending a Switch Binary Set command

## 11. Associations

Use associations for direct communication between the Smart Plug 16A and other devices within your Z-Wave network without the need of your primary gateway (hub).

### Association Groups:

#### Root device:

ID	Name	Allowed nodes	Description
1	Lifeline	1	Supports the following command classes: <ul style="list-style-type: none"> <li>• Device Reset Locally: triggered upon request</li> <li>• Meter Report: triggered according to Configuration parameters 40 and 42</li> <li>• Notification Report: triggered on overload/overcurrent or according to Configuration parameters 70, 71 and 72</li> <li>• Switch Binary Report: triggered upon request or according to Configuration parameters 11 and 12</li> </ul>
2	Plug Status	5	Supports the following command classes: <ul style="list-style-type: none"> <li>• Basic set: triggered at change of relay state</li> </ul>
3	Plug Threshold	5	Supports the following command classes: <ul style="list-style-type: none"> <li>• Basic set: triggered at change of active power in combination with Configuration parameters 50, 51 and 52</li> </ul>

## 12. Notification Command Class

The Smart plug supports multiple notifications:

- In case of exceeding the maximum current of 16.1A for 5 seconds or more the Smart plug automatically turns off and the overcurrent notification is sent.
- The Smart plug detects also any voltage drop/drift or overvoltage (10% change from the 230V) and send the corresponding notification.
- If activated with parameter 70, the Smart plug detects also overloads. If power exceeds the value set in parameter 70 for more than 3 seconds an overload notification is sent to the controller.
- It also supports the Notification Type Appliance. This notification is enabled with parameter 71, when the user sets a power threshold value. When the set value is reached a program started notification is sent and when the device connected to the plug stops working a program completed notification is sent.

Notification Type	Notification Event
Power management (0x08)	Voltage drop/drift (0x05)
Power management (0x08)	Over-current detected (0x06)
Power management (0x08)	Over-voltage detected (0x07)
Power management (0x08)	Over-load detected (0x08)
Appliance (0x0C)	Program started (0x01)
Appliance (0x0C)	Program in progress (0x02)
Appliance (0x0C)	Program completed (0x03)

## 13. Firmware update

Smart plug supports OTA (over the air) Firmware update.



## 14. Configuration Parameters

### Parameter no. 11 - Turn Smart plug 16A Off Automatically with Timer

If Smart plug 16A is ON, you can schedule it to turn OFF automatically after a period defined in this parameter. The timer is reset to zero each time the device receives an ON command, either remotely (from the gateway (hub) or associated device) or locally from the switch.

Values (size is 2 byte dec):

- default value 0
- 0 - Auto OFF Disabled
- 1 - 32535 = 1 - 32535 seconds. Auto OFF timer enabled for a given number of seconds.

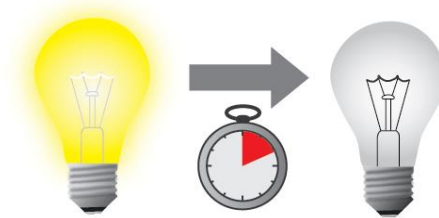

### Parameter no. 12 - Turn Smart plug 16A On Automatically with Timer

If Smart plug 16A is OFF, you can schedule it to turn ON automatically after a period of time defined in this parameter. The timer is reset to zero each time the device receives an OFF command, either remotely (from the gateway (hub) or associated device) or locally from the switch.

Values (size is 2 byte dec):

- default value 0
- 0 - Auto ON Disabled
- 1 - 32535 = 1 - 32535 seconds. Auto ON timer enabled- for a given amount of seconds.

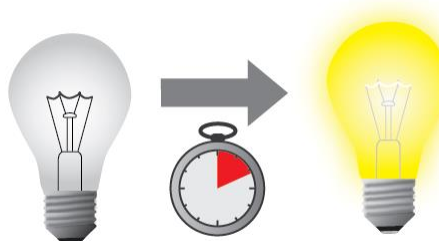

### Parameter no. 30 - Restore on/off status for Smart plug 16A after power failure

This parameter determines if on/off status is saved and restored for the Smart plug 16A after power failure.

Values (size is 1 byte dec):

- default value 0
- 0 - Device saves last on/off status and restores it after a power failure.
- 1 - Device does not save on/off status and does not restore it after a power failure, it remains off.



### Parameter no. 40 – Watt Power Consumption Reporting Threshold for Smart plug 16A

Choose by how much power consumption needs to increase or decrease to be reported. Values correspond to percentages, so if 20 is set (by default), the device will report any power consumption changes of 20% or more compared to the last reading.

Values (size is 1 byte dec):

- default value 20
- 0 - Power consumption reporting disabled
- 1 - 100 = 1% - 100% Power consumption reporting enabled. New value is reported only when Wattage in real time changes by more than the percentage value set in this parameter compared to the previous Wattage reading, starting at 1% (the lowest value possible).

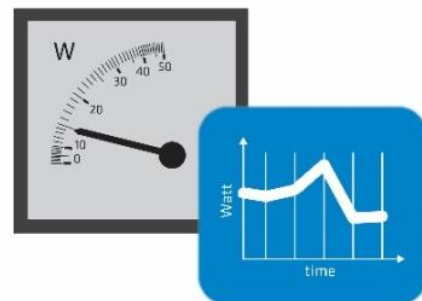

Power consumption needs to increase or decrease by at least 1 Watt to be reported, REGARDLESS of percentage set in this parameter.

NOTE: When reporting Watts, module will automatically report also [V] (Voltage) and [A] (Amperes)

## Parameter no. 42 – Watt Power Consumption Reporting Time Threshold for Smart plug 16A Load

Set value refers to the time interval with which power consumption in Watts is reported (30 – 32535 seconds).

Values (size is 2 byte dec):

- default value 0
- 0 - Power consumption reporting on time interval disabled
- 30 - 32535 = 30 - 32535 seconds. Power consumption reporting enabled. Report is sent according to time interval (value) set here.

The device is reporting the following values (if there was a change): W, V and A.

NOTE: The energy consumption (kWh) is reported regardless of the values, set in the parameters 40 and 42. The energy consumption will be reported, when it increases for at least 0,1 kWh.

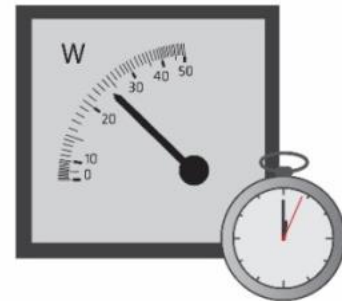

## Parameter no. 50 – Down value

Lower power threshold used in parameter no. 52.

Values (size is 2 byte dec):

- default value 30 = 30 W
- 0 – 4000 = 0W – 4000 W

Down value cannot be higher or equal to the value specified in parameter no. 51. If the set value is higher or equal to the value in parameter 51, the set command is ignored.

NOTE: if parameter no. 50 value is 100W, if measured power is lower than 100W, the association is sent.

Power threshold step is 1W.

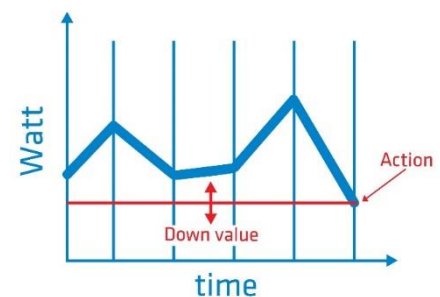

**Parameter no. 51 – Up value**

Upper power threshold used in parameter no. 52

Values (size is 2 byte dec):

- default value 50 = 50 W
- 0 – 4000 = 0 W – 4000 W

Up value cannot be lower or equal to the value specified in the parameter no. 50. If the set value is lower or equal to the value in parameter 50, the set command is ignored.

NOTE: If parameter no. 51 value is 200W. If measured power is higher than 200W the association is sent.

Power threshold step is 1W.

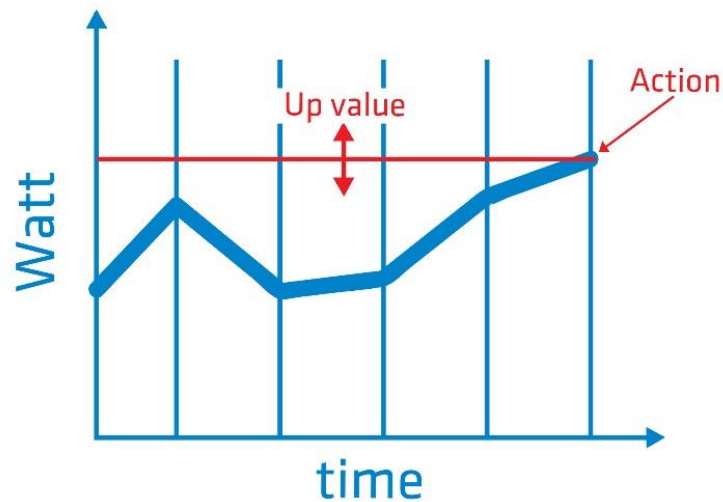

## Parameter no. 52 - Action in case of exceeding defined power values (parameters 50 and 51)

Parameter defines the way 3rd association group devices are controlled, depending on the current power load

Values (size is 1 byte dec):

- default value 6
- 0 – function inactive
- 1 – turn the associated devices on, once the power drops below Down value (parameter no. 50)
- 2 – turn the associated devices off, once the power drops below Down value (parameter no. 50)
- 3 – turn the associated devices on, once the power rises above Up value (parameter no. 51)
- 4 – turn the associated devices off, once the power rises above Up value (parameter no. 51)
- 5 – 1 and 4 combined. Turn the associated devices on, once the power drops below Down value (parameter no. 50). Turn the associated devices off, once the power rises above Up value (parameter no. 51).
- 6 – 2 and 3 combined. Turn the associated devices off, once the power drops below Down value (parameter 50). Turn the associated devices on, once the power rises above Up value (parameter no. 51).

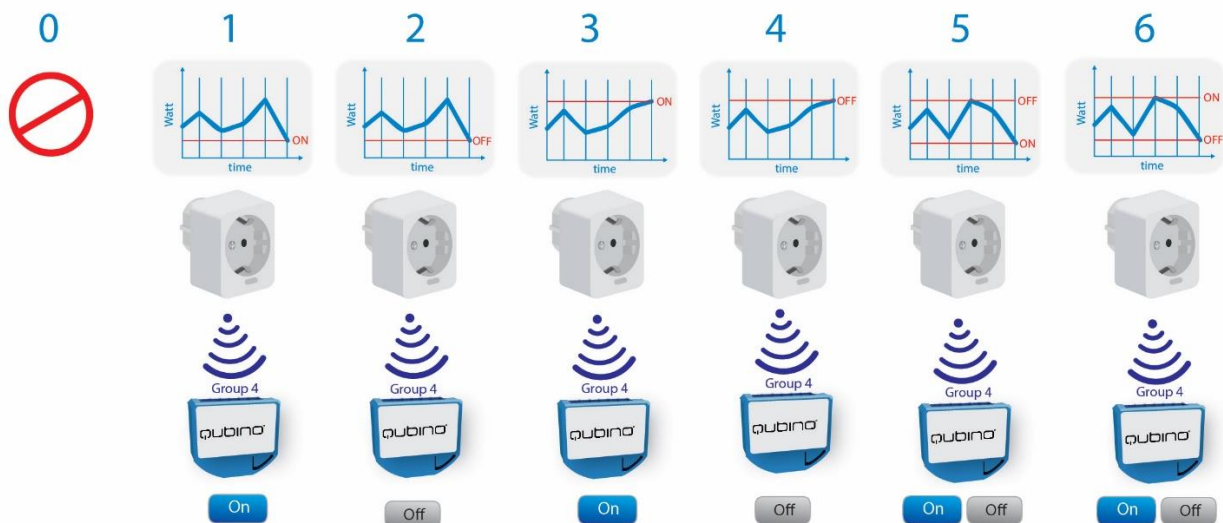

### Parameter no. 70 - Overload safety switch

The function allows for turning off the controlled device in case of exceeding the defined power for more than 3 seconds. Controlled device can be turned back on by S-button or sending a control frame. By default this function is inactive.

Values (size is 2 byte dec):

- default value 0
- 1 – 4000 = 1 W – 4000W
- 0 = function not active

NOTE: This functionality is not an overload safety protection, please check installation note for details.

In case of overload the following message will be send towards the controller:

- COMMAND\_CLASS\_NOTIFICATION\_V5
- The Alarm V1 type field set to 0x00
- Notification Type 0x08 and 0x08  
(Overload detected)

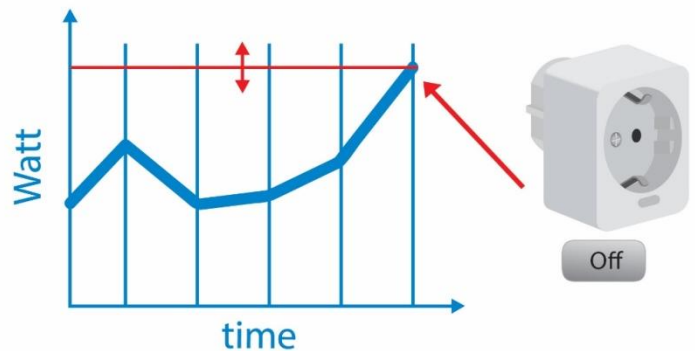

NOTE: Regardless of the value set in this parameter the overcurrent protection is always active and can not be disabled.

### Parameter no. 71 – Power threshold

This function allows setting the power threshold for triggering the Program started notification. When the threshold is reached, the notification will let the user know that the device connected to the smart plug started working.

Values (size is 2 byte dec):

- default value 0
- 1 – 4000 = 1 W – 4000W
- 0 = function not active

When the threshold is reached the following message will be send towards the controller:

- COMMAND\_CLASS\_NOTIFICATION\_V5
- The Alarm V1 type field set to 0x00
- Notification Type 0x0C and 0x01 (Program started)

### Parameter no. 72 – Time interval

This function allows setting the time interval for triggering the Program completed notification. When the active power will fall below the power threshold set in parameter 71, the time interval will start and when it will expire the notification will let the user know that the device connected to the smart plug finished working. The time interval is useful for the devices that have pause intervals during operations.

Values (size is 1 byte dec):

- default value 1
- 0 – 125 = 0 – 125 minutes
- 0 = immediate sending of notification when active power drops below the threshold set in the parameter 71

When the time interval expires the following message will be send towards the controller:

- COMMAND\_CLASS\_NOTIFICATION\_V5
- The Alarm V1 type field set to 0x00
- Notification Type 0x0C and 0x03 (Program completed)

### Parameter no. 73 – Turn Smart Plug OFF

This function allows turning the Smart Plug output to OFF once the time interval is expired and the Program completed notification is sent to the controller.

Values (size is 1 byte dec):

- default value 0
- 0 – function disabled
- 1 – turn OFF relay once the notification Program completed is sent

### Parameter no. 74 – Enable/disable LED

This function allows enabling or disabling the Smart Plug LED. In case the user doesn't want the LED indicator, it can be turned OFF with this parameter.

NOTE: if an overload or overcurrent occurs the red LED will still turn ON regardless of the value set in this parameter.

Values (size is 1 byte dec):

- default value 1
- 0 – LED is disabled
- 1 – LED is enabled

## 15. Technical Specifications

Power supply	230 VAC $\pm$ 10% / 50 Hz
Power load	16A resistive max.
Overload protection	> 16A
Power consumption	< 1W
Housing dimensions	43 x 52 x 75 mm
Package dimensions	70 x 70 x 55,5 mm
Housing colour	white
Weight (ex. packaging)	~ 80g
Weight with packaging	~ 101g
Z-Wave operation range	up to 30 m indoors (98 ft)
Operating temperature	0 ~ +40°C (32 ~ 104°F); <80% RH non-condensing
Storage operation	-20 ~ +70°C (-4 ~ 158°F); <80% RH non-condensing
Plug & Socket type	Plug Type F, Socket compatible with type C and F
Switching	Relay
IP	20
Repeater	Yes
Power measurement accuracy	0,1 W



## 16. Z-Wave Command Classes

### ROOT DEVICE:

GENERIC TYPE: GENERIC\_TYPE\_SWITCH\_BINARY

SPECIFIC TYPE: SPECIFIC\_TYPE\_POWER\_SWITCH\_BINARY

### Supported Z-Wave Command Classes:

COMMAND\_CLASS\_ZWAVEPLUS\_INFO\_V2,

COMMAND\_CLASS\_SUPERVISION\_V1,

COMMAND\_CLASS\_TRANSPORT\_SERVICE\_V2,

COMMAND\_CLASS\_SECURITY\_V1,

COMMAND\_CLASS\_SECURITY\_2\_V1

COMMAND\_CLASS\_VERSION\_V2 [S0]\* [S2]\*

COMMAND\_CLASS\_DEVICE\_RESET\_LOCALLY\_V1 [S0]\* [S2]\*

COMMAND\_CLASS\_MANUFACTURER\_SPECIFIC\_V2 [S0]\* [S2]\*

COMMAND\_CLASS\_POWERLEVEL\_V1 [S0]\* [S2]\*

COMMAND\_CLASS\_SWITCH\_BINARY\_V2 [S0]\* [S2]\*

COMMAND\_CLASS\_METER\_V4 [S0]\* [S2]\*

COMMAND\_CLASS\_NOTIFICATION\_V5 [S0]\* [S2]\*

COMMAND\_CLASS\_ASSOCIATION\_V2 [S0]\*[S2]\*

COMMAND\_CLASS\_ASSOCIATION\_GRP\_INFO\_V2 [S0]\* [S2]\*

COMMAND\_CLASS\_CONFIGURATION\_V1 [S0]\* [S2]\*

COMMAND\_CLASS\_FIRMWARE\_UPDATE\_MD\_V4 [S0]\* [S2]\*

\*[S0] Security Command Class

\*[S2] Security S2 Command Class

### NOTE:

COMMAND\_CLASS\_METER\_V1

- Default values:
  - Rate Type = 1 (Import)
  - Scale = 0 (kWh)

This Security Enabled Z-Wave Plus Product can be included and operated in any Z-Wave network with other Z-Wave certified devices from any other manufacturers. All constantly powered nodes in the same network will act as repeaters regardless of the vendor to increase reliability of the network.

## 17. Z-Wave Security

Qubino’s Smart Plug supports the latest Security 2 feature. Security S2 is handled by the Strong AES 128 Encryption protocol, which means that the S2 makes Z-Wave the most secure IoT (Internet of Things) security platform out there. In order to fully utilize the product and its SECURITY 2 feature, a Security Enabled Z-Wave gateway (hub) must be used.

### Authenticated Control

- Out-Of-Band Device Specific Key for inclusion
- May be used by most implementations

Also supports: Security S2 Unauthenticated, Security S0 and Unsecure inclusion

**IMPORTANT:** When adding the Smart Plug 16A to a Z-Wave network with a controller supporting Security 2 (S2), the PIN code of the Z-Wave Device Specific Key (DSK) is required. The unique DSK code is printed on the product label and a copy is inserted in the packaging, which must not be lost. Do not remove the DSK from the product. As a backup measure, use the label in the packaging.

The first five digits of the key are highlighted or underlined to help the user identify the PIN code portion of the DSK text.

The DSK is additionally represented with a QR Code as shown here.



### DSK label and QR code (example)

A joining node requesting to join the S2 Access Control Class or the S2 Authenticated Class will obfuscate its Public Key by setting the bytes 1..2 to zeros (0x00) before transferring its key via RF.

A joining node requesting to join only the S2 Unauthenticated Class will send the its full Public Key when transferring the key via RF as the including node has no access to the DSK.

The DSK may be used for out-of-band (OOB) authentication.

- The including gateway (hub) may use QR code scanning device to read the entire DSK off the joining device and match it with the obfuscated public key received via RF from the joining device.

## 18. Important Disclaimer

Z-Wave wireless communication is not always 100% reliable. This device should not be used in situations in which life and/or valuables are solely dependent on its functioning. If the device is not recognized by your gateway (hub) or shows up incorrectly, you may need to change the device type manually and make sure your gateway (hub) supports multi-channel devices. Contact us for help before returning the device: <http://qubino.com/support/#email>

## 19. Warning

Do not dispose of electrical appliances as unsorted municipal waste, use separate collection facilities. Contact your local government for information regarding the collection systems available. If electrical appliances are disposed of in landfills or dumps, hazardous substances can leak into the groundwater and get into the food chain, damaging your health and well-being. When replacing old appliances with new ones, the retailer is legally obligated to take back your old appliance for disposal free of charge.

## 20. Regulations

### Legal Notice

This user manual is subject to change and improvement without notice. GOAP d.o.o. Nova Gorica reserves all rights to revise and update all documentation without any obligation to notify any individual or entity.

### Declaration of Conformity

Qubino Smart Plug 16A device is compliant with the essential requirements and other relevant provisions of the Low voltage (LVD) Directive (2014/35/EU), Electromagnetic Compatibility (EMC) Directive (2014/30/EU), Radio Equipment Directive (2014/53/EU), Directive RoHS 2 (2011/65/EU) and Directive ErP (2009/125/EC).

### WEEE

According to the WEEE (Waste electrical and electronic equipment) Directive, do not dispose of this product as household waste or commercial waste. Waste electrical and electronic equipment should be appropriately collected and recycled as required by practices established for your country. For information on recycling of this product, please contact your local authorities, your household waste disposal service or the shop where you purchased the product.



**NOTE: User manual is valid for device with SW version S2 (SW version is part of P/N)!**

**Example:P/N: ZMNHYDxHxS2Px**

**GOAP d.o.o. Nova Gorica**

Ulica Klementa Juga 007, 5250 Solkan, Slovenia

E-mail: [info@qubino.com](mailto:info@qubino.com)

Tel: +386 5 335 95 00

Web: [www.qubino.com](http://www.qubino.com)

Date: 26.11.2018; V 2.5

---

[DON'T MISS OTHER INVENTIONS FROM QUBINO– CLICK HERE AND CHECK OUT QUBINO'S COMPLETE PORTFOLIO](#)