

Octane[®]

F I T N E S S



OPERATIONS MANUAL

Q37x

Q37xi

Q47x

Q47xi

TABLE OF CONTENTS

GETTING STARTED	2
• Important Safety Information	2
• Warranty Information	2
• Learn More...and Join the Octane Fitness Community	2
• Visual Product Overview	3
• SMARTLINK® by Octane Fitness	3
• User Set-Up Functions	4
• Cleaning and Maintenance	4
ELECTRONICS	5
• Keypad Buttons	5
• Console Options	8
• Octane Boosters	9
• Dynamic Display (LCD)	10
• SMARTLIGHT®	11
OCTANE FITNESS PROGRAMS	12
• How Does Workload Resistance (Level) Work?	12
• What Are the CROSS CiRCUIT® Programs?	12
• The Optional CROSS CiRCUIT Kit	13
• Q37/Q47 Program Settings—Value Ranges	13
• Q37/Q47 Program Reference	14
PRODUCT FEATURES	18
• Heart Rate Monitoring and HeartLogic Intelligence™	18
• Electronically Adjustable Stride with SmartStride™ (Q47)	19
ENJOY YOUR OCTANE FITNESS ELLIPTICAL	21

GETTING STARTED

Get ready to Fuel Your Workout with the Octane Fitness elliptical cross trainer! You will soon be challenging yourself with a variety of pre-programmed workouts managed by sophisticated electronics that keep you interested and motivated. Getting started is easy—just step on and start pedaling. Follow the prompts to program your workout, and you are on your way!

Important Safety Information

Anyone using this product should consult a physician before starting an exercise program. This is especially important for persons over 35 or those with pre-existing health conditions. If at any time during a workout an exerciser experiences chest pains, nausea, dizziness, or shortness of breath, he or she should stop exercising immediately and consult a physician before starting again.

The Octane Fitness Product Safety Information for Q Series Ellipticals (Part Number 108627-001), shipped with the product, contains important details for safe set-up and operation of the Octane Fitness elliptical. Users are expected to review this document before using the elliptical.

Warranty Information

The Octane Fitness elliptical is warranted to be free of all defects in material and workmanship for a specific period of time from original date of purchase. Please refer to the Octane Fitness Limited Consumer Warranty (Part Number 104198-001) included in your information packet for full terms and details of warranty coverage.

Learn More...and Join the Octane Fitness Community!

Should you have any questions regarding your elliptical, please log on to www.octanefitness.com where you will find answers to many common questions and tips on using your elliptical. If you would like to speak to an Octane Fitness Customer Service specialist, please call 1-888-OCTANE4 or 763-757-2662 extension 1.

Or...find Octane Fitness on your favorite social media site—Facebook, Twitter, YouTube or Pinterest! Just search for “Octane Fitness” to get connected with a community of users who are enjoying free downloads and workout inspiration in a team atmosphere. Come join us!



search: Octane Fitness

Visual Product Overview

Enjoy the many great features of your Octane elliptical:

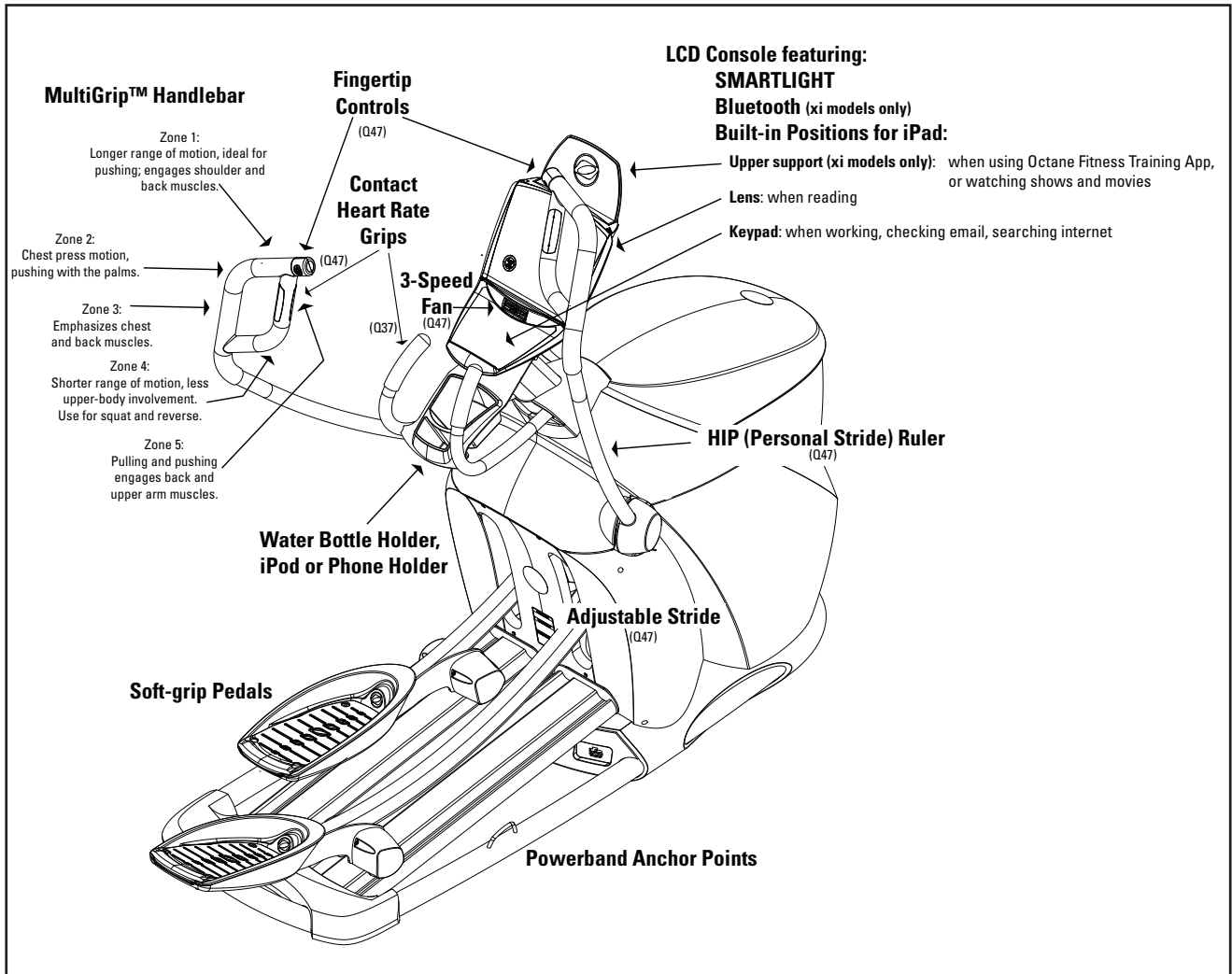

SMARTLINK® by Octane Fitness

To ramp up your workout and take full advantage of the features and programming of your Q37xi or Q47xi elliptical, head to the iTunes Store and download SMARTLINK by Octane Fitness for your iPad*. This free app guides your workouts, tracks your progress and offers great motivation to keep pushing toward your goals.

* SMARTLINK is compatible with the following 3rd- and 4th-generation iPad and iPad mini models: A1403, A1416, A1430, A1432, A1458, A1454, A1455, A1459, A1460.

User Set-up Functions

Program features, console settings, and controls of the Q37x/Q37xi and Q47x/Q47xi ellipticals can be adjusted to fit your personal preferences or workout environment. To access the User Set-up functions, press and hold both the Level (▲) and Level (▼) keys for three seconds, or until you hear a beep. The following customizable functions are displayed in sequence; use the ENTER key to toggle through the available options for each function, and press any (▲) or (▼) key to select a setting and move to the next function. To exit without changing any values, press PAUSE CLEAR twice. Once saved, values become the new standard and do not need to be reset for each use.

Warm-Up	This feature may be turned "ON" (to include a 3-minute warm-up in each workout) or "OFF". Heart rate controlled programs and advanced programs always include a 3-minute warm-up, even if the warm-up is turned off here. The factory default setting is "ON".
Pause	Turning this function to "OFF" lengthens to 10 minutes the period of time before a program automatically enters a value during programming. The factory default setting is "ON", which is the appropriate setting for a typical user. The "OFF" setting is primarily used during product demonstrations.
Clock Direction	The Octane elliptical can track workout time by counting "UP" or "DOWN". The factory default setting is "UP".
Units	You may choose to have the weight and distance units displayed in "ENGLISH" (pounds and miles) or "METRIC" (kilograms and kilometers). The factory default setting is "ENGLISH".
Beep	You may turn the console sounds "ON" or "OFF". The factory default setting is "ON".
ID	If you have more than one Octane Q37 or Q47 on site, use this setting to give each a unique identification number for pairing with your iPad. Choose any value between 0 and 127. The factory default setting is 1.
Exit	When EXIT is displayed, press Enter to leave User Set-up. All of your selections will be saved and become the new standard settings for your machine. They may be changed at any time by repeating these set-up procedures.

Cleaning and Maintenance of the Q37 and Q47 Series Elliptical

WARNING! This machine contains moving parts. Take caution when trying to locate and fix any problem with the machine.

Your Octane Fitness elliptical has been manufactured to withstand many hours of hard use with minimal required maintenance. **Use only a soft, slightly damp lint-free cloth to clean the console lens of your elliptical.** Abrasive cloths, towels, paper towels, and similar items may cause damage to surface. Do not use window cleaners, household cleaners, aerosol sprays, solvents, alcohol, ammonia, or abrasive cleaners, as they, too, may damage the lens. **Do not use bleach on the console as it will damage the surface.**

Use a clean towel with a mild soap and water solution to clean tracks and rollers, Powerband handles and shrouds after use. Powerbands may be cleaned with Armor All® or a similar cleaning product to restore the original shine.

Please contact your local Octane Fitness dealer should you have any questions or encounter any maintenance issues with your elliptical. If you would like to speak directly to an Octane Fitness customer service specialist, please call 888.OCTANE4 or 763.757.2662, ext. 1, or visit www.octanefitness.com.

ELECTRONICS

The Octane Fitness ellipticals feature simple, easy to understand keypads and a dynamic display which provides all the information you need to get started and stay motivated during your workout. Check out the program descriptions found later in this manual to choose the workout that is just right for you.

Getting started is easy—just hop on and start pedaling, then **choose your workout** and **adjust the settings**. DedicatedLogic™ programming gives you the ultimate in ease of use and total flexibility for programming your console. This allows you to start your workout, then program the electronics, and to change settings at any time during your workout. This ease of use starts by giving each key only one function. This makes it easy to understand how each key works.

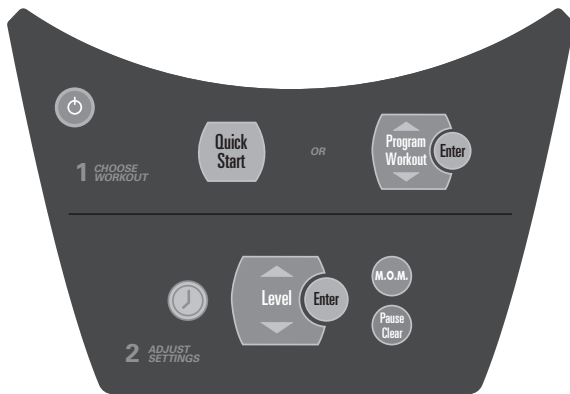

Q37x

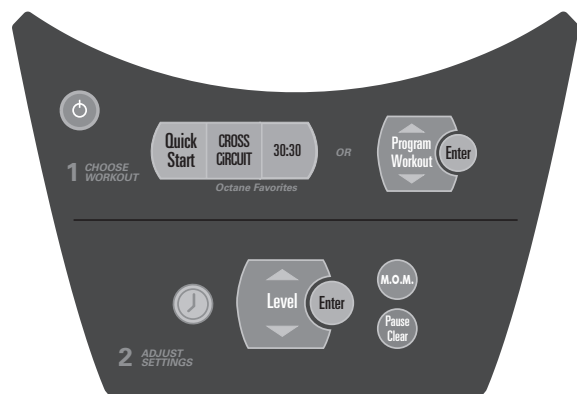

Q37xi

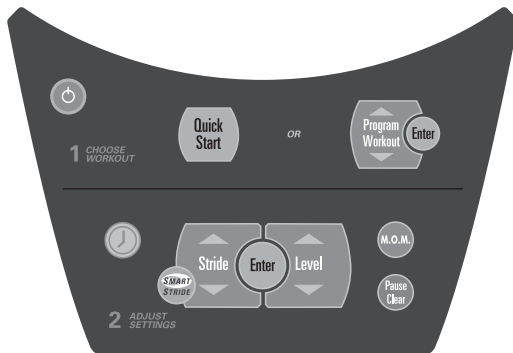

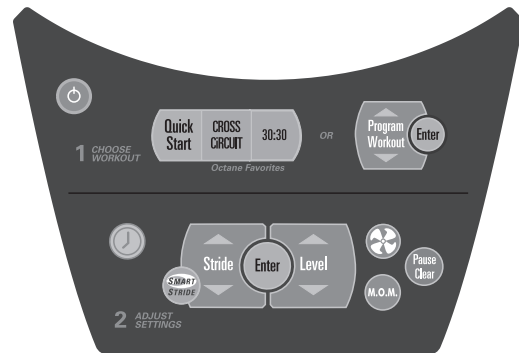

Q47x



Q47xi

Keypad Buttons

	<p>The Power button turns the LCD console on or off.</p>
<p>Quick Start</p>	<p>The easiest way for you to start your workout is to simply push the Quick Start button, setting the machine in a manual program at resistance Level 1 and Stride Length 21". The calories readout will be based on a 150 lb. (68 kg) user, age 40. Once you have selected Quick Start, you can program Time, Level or Stride (on the Q47) in any order. (Age and Weight can only be changed by selecting one of the Programs on your elliptical and entering the values during Program set-up.)</p>

<p>CROSS CiRCUIT (Q37xi, Q47xi)</p>	<p>Press the CROSS CiRCUIT button on the Q37xi or Q47xi to get right into the CROSS CiRCUIT Time program, an Octane Favorite! This program combines cardio intervals on the elliptical with sets of strength and toning exercises off the machine using simple equipment such as hand weights or a fitness ball or the optional CROSS CiRCUIT foot platforms and Powerbands.</p>
<p>30:30 (Q37xi, Q47xi)</p>	<p>Another Octane Favorite is 30:30. Press this button on the Q37xi or Q47xi to take on this challenging program which provides a simple test of fitness level with 5 sets of 30-second sprint and recovery intervals. For each set, the program monitors heart rate and calculates the average minimum and average maximum heart rates and the average number of beats the heart rate recovers between sprint intervals. Heart rate recovery is a relative indicator of fitness level; a higher number indicates a more rapid heart rate recovery and therefore represents a relatively better level of fitness. Note: For this program to work properly, you must be wearing a wireless heart rate transmitter or consistently grasping the contact heart rate sensor grips on the stationary handlebars.</p>
<p>SmartStride (Q47x, Q47xi)</p>	<p>SmartStride, available exclusively on Octane Fitness Q47 series ellipticals, automatically replicates natural movement by analyzing and measuring an exerciser's pace and direction and intuitively adjusting stride length in 1-inch (2-centimeter) increments from 18 inches (46 cm) to 26 inches (66 cm). Press the SmartStride button and pedal at a comfortable walking speed. The machine will analyze your stride to set a baseline. Then, as you workout and your pace or direction changes, SmartStride makes the appropriate adjustments to your stride length. Size-based programming (described later in this manual) allows you to set the starting forward stride length that best fits your leg length and fitness level. To deactivate SmartStride, simply push the SmartStride button a second time.</p>
<p>Fan (Q47xi)</p>	<p>Press the Fan button on the Q47xi to initiate a cool breeze to help keep you comfortable as you workout. Press again to increase the airflow (two additional levels), or a fourth time to turn it off. Move the vent as desired to direct the airflow.</p>
<p> M.O.M.</p>	<p>Press this button and then press ENTER to activate Movement Management Mode (M.O.M.), a unique control feature offered on Octane Fitness ellipticals which disables the console buttons and increases the resistance in the movement of the pedals so that the pedals do not move as easily. The  icon in the lower right corner of the LCD lights to show that M.O.M. is activated, and the keypad does not respond to key presses. This control feature may discourage children from experimenting with the machine. To unlock M.O.M., press the button again, holding it for 3 seconds until the console responds.</p> <p>CAUTION! M.O.M. mode is provided to reduce the likelihood that children can pedal the elliptical cross-trainer. This feature does not lock the machine; the pedals still move and the potential for injury still exists. It is the responsibility of the user to supervise children and keep them off the elliptical cross trainer to minimize the likelihood of injury.</p>
<p>Pause Clear</p>	<p>Press once to pause your workout. The standard pause time is 10 minutes. To restart a paused workout, push any key or just begin pedaling. If you stop pedaling during a workout, the unit will automatically begin a pause phase; simply start pedaling to resume your workout. Press the Pause Clear button twice within two seconds, and your machine is reset and ready for another workout.</p>

Up and Down Keys	
Program Workout	Press the Program Workout (▲) or (▼) to scroll through the programs, then press Enter to select a program. Program changes can be made any time during your workout. When you change programs, the LCD message center prompts you to enter new program values as needed.
	Press the clock button (Time), then (▲) or (▼) to increase or decrease the time of your workout, in 1 minute increments. The standard workout time is 30:00. The maximum time is 99:00.
Stride <i>(Q47x, Q47xi)</i>	The Q47x and Q47xi ellipticals feature an adjustable stride. Press Stride (▲) or (▼) to increase or decrease the stride length of the machine. Each key press equals one-half (1/2) inch (English) or one centimeter (metric). The stride length ranges from 18 inches (46 cm) to 26 inches (66 cm). The default stride length for preset resistance and heart rate controlled programs is 21" (52 cm). For variable stride programs, the default forward or long stride is 21" (52 cm) and the default backward or short stride is 18" (46 cm).
Level	Press Level (▲) or (▼) to increase or decrease the resistance level of the machine. There are 20 levels of resistance for preset resistance programs and the 30:30 fitness number program. <i>For heart rate controlled programs on the Q37xi and Q47xi, the Level button increases your target heart rate. To save a change in target heart rate, press Enter.</i>
Enter	Selects any of the changed values or items from the above keys. Also, pressing the Enter key during any workout will stop the LED readout windows from toggling between display modes.

Console Options

Your Octane Fitness elliptical is equipped with one of two console options, the 'x' or the 'xi'. All models feature a selection of pre-programmed workouts, the Octane Fitness Workout Boosters, and the SMARTLIGHT lightbar and dynamic LCD to provide workout directions and feedback.



The deluxe Q37xi and Q47xi consoles also offer wireless heart rate monitoring, multiple colors in the SMARTLIGHT and an upper dock and SMARTLINK connectivity for your iPad*.



* SMARTLINK is compatible with the following 3rd- and 4th-generation iPad and iPad mini models: A1403, A1416, A1430, A1432, A1458, A1454, A1455, A1459, A1460.

Octane Boosters

Your Octane Fitness Elliptical offers three ‘boosters’ to add motivation and variety to your workout. Press the “Boost Your Workout” button on the console to toggle through and choose one of these great challenges:

<p>X-Mode</p>	<p>This great motivational tool keeps your workout fresh and exciting in any program. Every other minute X-Mode kicks in, prompting you to perform combinations of eight different challenges:</p> <p>Fast Pick up the pace—we recommend 50-60 rpm, but you should find your own comfort level.</p> <p>Squat Bend slightly at the knees as you pedal. You’ll feel this one in your quadriceps and glutes in no time!</p> <p>Reverse Pedal backwards to change the muscle focus on your entire lower body.</p> <p>Lean Back Grab the stationary handlebars and lean slightly backwards. This changes the muscle focus to your lower body. You will feel this in your quadriceps.</p> <p>Lower Body Only Either hold the stationary handlebars or naturally swing your arms.</p> <p>Push-Arms Focus on pushing with your arms to work your chest and triceps.</p> <p>Pull-Arms Focus on pulling with your arms to work your biceps and lats.</p> <p>Slow Slow down to 30-40 rpm to allow yourself to recover.</p> <p>During an X-Mode session, the level of resistance can be changed by pressing any (▲) or (▼) key on the keypad.</p>
<p>ArmBlaster</p>	<p>Press the “Boost Your Workout” button a second time to select ArmBlaster, a proprietary program designed to boost cardiovascular endurance while building strength and muscle tone. ArmBlaster adds upper-body strength sessions to the cardio program profile that you have selected. Every minute, resistance increases for a muscle-building, 10-repetition set as you transfer the workload from your lower body to your upper body. During the ArmBlaster rep countdown, the level of resistance can be changed by pressing any (▲) or (▼) key.</p> <p><i>Tip: If your elliptical is equipped with the optional CROSS CiRCUIT⁺ stationary foot platforms, step onto the platforms during your ArmBlaster sessions for an even more intense upper-body challenge.</i></p>
<p>GluteKicker</p>	<p>GluteKicker is an aggressive subset of X-Mode that is focused on your glutes, hips, and thighs. It uses four prompts: Reverse, Squat, Fast, and Lean Back. Initiate GluteKicker sessions by pressing the “Boost Your Workout” button a third time. Each session lasts for one minute, followed by a one-minute recovery period. During the GluteKicker session, the level of resistance can be changed by pressing any (▲) or (▼) key on the keypad or the right handlebar.</p>

A fourth click of the “Boost Your Workout” button cancels all boosters.

Note: On the **Q37xi** and **Q47xi** you can customize some of the booster settings, such as interval times and resistance changes. Just press and hold the Booster button until you hear a beep, then follow the prompts in the LCD message center, using the (▲/▼) and Enter keys to make your selections.

Dynamic Display (LCD)

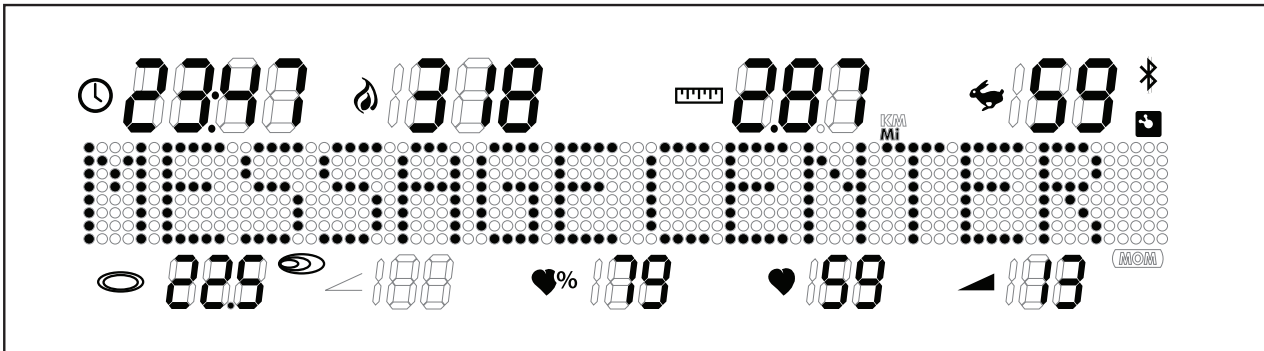

The LCD display prompts you to enter important information, dynamically displays all of the important workout data and highlights aspects of your workout such as upcoming intervals and resistance changes. Watch the display as you set up and progress through your workout—it will guide you, motivate you, and reward you with summary information at the end of your session.



Displays workout **time**, counting up from 0:00. Time can be increased or decreased during your workout. The maximum time that users can set is 99:00. When actual workout time is displayed, the timer goes up to 99:59, then the display rolls over to 0:00. Refer to User Set-up Functions to learn how to switch from a “count up” to “count down” display.



Displays an estimate of the total **calories** burned during the workout, based on the user’s entered weight. If no specific weight is entered, calories are based on a 150 lb. (68 kg) user..



Displays an estimate of the **distance** you have traveled. Distance can be shown in either miles (English) or kilometers (metric). When you first purchase your elliptical the display will be in English. Refer to User Set-up Functions to learn how to switch from English to metric. **Note:** *On the elliptical, 400 revolutions is approximately one mile; therefore, if you are pedaling at 50 rpm, you will “travel” approximately one mile in 8 minutes.*



Displays your current **speed** in revolutions per minute (rpm).



When lit, this icon indicates that **Bluetooth**® wireless communications is active.

(Q37xi, Q47xi)



When lit, this icon indicates that **ANT+**™ wireless communications is active and detecting signal from the optional wireless heart rate chest strap.

(Q37xi, Q47xi)



(Q47x, Q47xi)

Displays your **stride length**, the approximate horizontal distance of the elliptical pattern in inches (English) or centimeters (metric). The stride length ranges from 18 inches (46 cm) to 26 inches (66 cm).



(Q47x, Q47xi)

When lit, this icon indicates that SmartStride is activated. As you vary your pace and direction, SmartStride intuitively adjusts stride length in 1-inch (2-centimeter) increments to replicate natural movement. Press the SmartStride button on the keypad to deactivate SmartStride.

♥%
(Q37xi, Q47xi)

Displays your current **heart rate percentage** (current heart rate / theoretical maximum heart rate). **Note:** You must have entered your age during program setup and be wearing a wireless heart rate transmitter or consistently grasping the contact heart rate sensor grips on the handlebars in order to get an accurate reading of Heart Rate %.



Displays **heart rate** in beats per minute (BPM). **Note:** You must be wearing a wireless heart rate transmitter or consistently grasping the contact heart rate sensor grips on the stationary handlebars.



Displays the resistance **level** (1-20), where 1 is the lowest resistance level and 20 is the highest.



When lit, this icon indicates that **M.O.M.** mode (described under “Keypad Buttons”) is active.

SMARTLIGHT®



SMARTLIGHT at the top of the console communicates important information for your workout. On all models of the Q37 and Q47, SMARTLIGHT functions primarily as an intensity meter, giving you visual affirmation as your resistance level or speed increases or decreases.

On the deluxe Q37xi and Q47xi models, SMARTLIGHT uses multiple colors to communicate additional information about your workout:

- **Workout Booster selection and status.** When no booster is selected, and between booster intervals, SMARTLIGHT is an orange intensity meter. When a booster is first selected, the color changes to indicate which booster is selected: XMode (green), GluteKicker (yellow) or ArmBlaster (blue). When a booster is active, SMARTLIGHT blinks to indicate that a booster session is about to begin.
- **Target Heart Rate “Zone meter”.** During heart-rate controlled programs, SMARTLIGHT is dark blue when your target heart rate is 10 or more beats lower than your goal, changing to light blue as you get closer to your goal, and to green when you are at target. SMARTLIGHT changes to yellow when your heart rate starts to go above your goal, and to red when you are 10 or more beats above your goal. When your workout is over and it’s time to cool down, SMARTLIGHT is a slowly blinking dark blue. Follow these color indicators as they prompt you to adjust your speed or intensity to keep your workout “in the zone”.
- **CROSS CiRCUIT program phase indicator.** During CROSS CiRCUIT program cardio intervals, SMARTLIGHT functions as an intensity meter. During a strength interval, SMARTLIGHT blinks on and off (in 1 second intervals) to help you count your off-machine time.

OCTANE FITNESS PROGRAMS

The **Q37x** has eight built-in programs to keep your workouts interesting:

Classic programs:	Manual—Random—Interval—Beginner
Goal programs:	Distance Goal—Calorie Goal
Cross-Circuit programs:	CC Time—CC Free

The **Q47x and Q47xi** also include two adjustable stride programs:

Stride programs:	Stride Interval—Dual Direction
------------------	--------------------------------

The **Q37xi** and **Q47xi** with wireless heart rate include an additional four programs to further challenge and motivate:

Heart rate and advanced programs: Fat Burn—HR Interval—30:30—MMA

Programs begin with a warm-up to ease your body into your intense workout. During the warm-up, the resistance increases each minute. At the end of the warm-up, you will be at your selected resistance value or target heart rate. You can change the level at any time during the warm-up.

Choose the program that best fits your workout needs for any given day. You decide how hard to work by setting the resistance level and goal (such as time, distance, or calories). Program your workout your way!

How Does Workload Resistance (Level) Work?

Nominal Level	Except as noted below, you select a consistent level of resistance for your workout, and increase or decrease it whenever you choose using the Level (▲) or (▼) keys on the keypad.
Program Level	The Random and Distance Goal programs let you select an overall resistance level for the program. This level is the average resistance level for the workout. The range of resistance levels during these workouts are plus (+) or minus (-) 4 of the entered program level. That is, for program Level 5, minimum resistance is Level 1 and maximum resistance is Level 9. During the workout, the overall program resistance level is displayed. You can change the Level at any time.
Resistance in Heart Rate Controlled Programs	Fat Burn and Heart Rate Interval ask you to enter the target heart rate level. If the target HR is reached during the warm-up, the warm-up ends and the selected heart rate controlled program begins. The resistance level during the heart rate controlled workout is controlled by the machine, increasing or decreasing as necessary to keep your heart rate on target.
Advanced Programs	In the advanced programs you select a Level for the 'work' portion of your workout. In 30:30, you enter a "Sprint" level, and for MMA you enter a "Fight" level. The rest and recovery intervals are set to Level 1.

What Are the CROSS CiRCUIT Programs?

CROSS CiRCUIT is a whole new way of working out with your Octane elliptical. These programs combine cardio intervals on the elliptical cross trainer with sets of strength and toning exercises off the machine using simple equipment such as hand weights or a fitness ball, or the optional CROSS CiRCUIT foot platforms and Powerbands.

The free SMARTLINK app works with your Q37xi or Q47xi and provides suggested exercises to target the lower body, upper body and core. Just choose the exercises that best suit your needs. Mix it up, keep it interesting, and watch your body change for the better with these great total-body workout alternatives!

Powerbands

Your Q37xi or Q47xi comes with two Powerbands to help you get started with your CROSS CiRCUIT strength training. The Powerbands should be attached at the anchor points as shown.

Note: When using the Powerband at the anchor point on the mast, pull from front of machine ONLY; do not pull the Powerband from the side of the machine as this may cause the machine to tip over.

Additional Powerbands and stationary foot platforms are available in the CROSS CiRCUIT+ Kit. Contact Octane Fitness Customer Service for purchase details and availability.

Use the quick-reference chart on the following pages to help select and set up the programs.

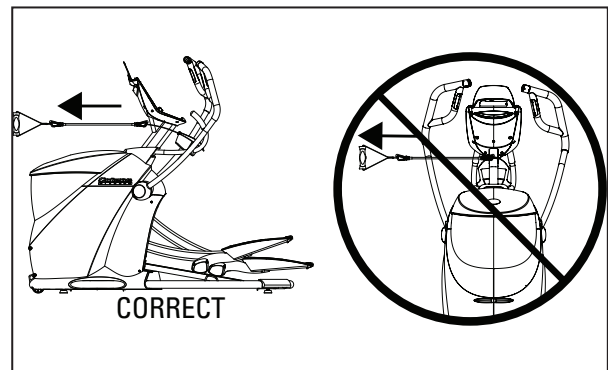
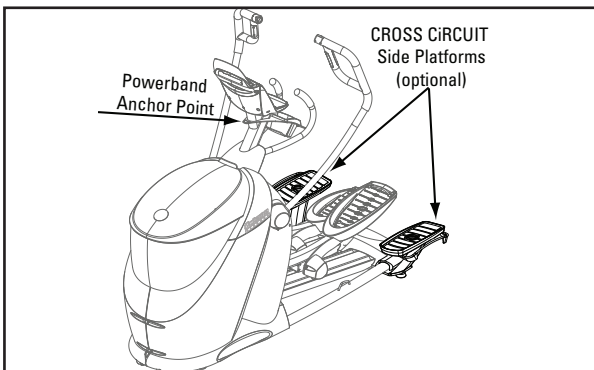

The Optional CROSS CiRCUIT+ Kit

Enhance your workout experience with the Octane Fitness CROSS CiRCUIT+ Kit. The kit, designed specifically for your Q37xi or Q47xi elliptical, includes stationary foot platforms that attach to the frame of the unit and three additional Powerbands to help you complete the CROSS CiRCUIT exercises.

For more information, or to purchase the CROSS CiRCUIT+ Kit, please contact your Octane Fitness dealer.

Q37x/xi and Q47x/xi PROGRAM SETTINGS—VALUE RANGES

Setting	Standard Values*	Minimum Value	Maximum Value
Time	30:00	1:00	99:00
Level	1	1	20
Age	40	15	99
Weight	150 lbs. (68 kg)	70 lbs. (32 kg)	300 lbs. (181 kg)
Stride	21" (52 cm)	18" (46 cm)	26" (66 cm)
Intervals	2	1	4
Interval (x) Time	00:30	00:15	99:00
Interval (x) Level	1	1	20
Target (Heart Rate)	(220 - Age) * %; varies by program	80	(220 - Age)
Calorie Goal	350	150	1000
Distance Goal	10K (6.2 miles)	1K (.62 miles)	21K (13.1 miles)
Cardio	2:00	0:30	10:00
Strength	1:00	0:30	10:00
Sprint Level (30:30)	8	4	20
Intensity	High	Low	High
Fight Level	6	1	20
Rounds	3	1	10
Long Stride Length	21" (52 cm)	18.5" (47 cm)	26" (66 cm)
Short Stride Length	18" (46 cm)	18" (46 cm)	25.5" (65 cm)
Forward Stride	21" (52 cm)	18.5" (47 cm)	26" (66 cm)
Reverse Stride	18" (46 cm)	18" (46 cm)	25" (64 cm)
Forward Level	4	2	20

*Standard program values are used if no values are entered within 4 seconds of Message Center prompts.

Q37 and Q47 PROGRAM REFERENCE

Press Program (▲) or (▼) and Enter to choose a program.

CLASSIC PROGRAMS

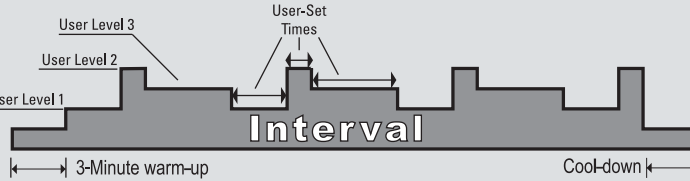
Programs & Standard Settings	Description
<p>Level ←</p> <div style="border: 1px solid black; padding: 5px; text-align: center; margin: 5px 0;"> Manual </div> <p style="text-align: center;">Time (30:00) Stride (21"/52 cm) (Q47x/Q47xi) Level (1) Age (40) Weight (150 lbs./68 kg)</p>	<p>Get on and go; constant resistance simulates walking or jogging on a flat surface. The oval racetrack equals 1/4 mile (or 400 meters); the counter in the matrix display shows laps completed.</p>
 <p style="text-align: center;">Random</p> <p style="text-align: center;">Time (30:00) Stride (21"/52 cm) (Q47x/Q47xi) Level (1) Age (40) Weight (150 lbs./68 kg)</p>	<p>Enjoy computer-randomized resistance variation with a virtually infinite number of combinations. Get a new course each time you select the program or change the level. Each interval lasts one minute.</p>
 <p style="text-align: center;">Interval</p> <p style="text-align: center;">Time (30:00) Stride (21"/52 cm) (Q47x/Q47xi) Intervals (2) Interval 1 — Time (00:30) Interval 1 — Level (1) Interval n — Time (00:30) Interval n — Level (1) Age (40) Weight (150 lbs./68 kg)</p>	<p>Design a custom workout of up to 4 alternating intervals of user-defined duration and resistance. Use Level (▲) or (▼) to adjust interval resistance mid-workout.</p>
<p style="text-align: center;">Combination of resistance level, time, and recommended speed (RPM)</p> <p>Level ←</p> <div style="border: 1px solid black; padding: 5px; text-align: center; margin: 5px 0;"> Beginner </div> <p style="text-align: center;">Day (1)</p>	<p>Follow a 14-day planned workout sequence to help jump-start your exercise program. Each day's workout includes preset values for resistance level, time and a suggested speed (RPM). The values gradually increase in intensity each day, building up your stamina and getting you ready to workout on your own. Use Level (▲) or (▼) to chose the day (1-14) and you're ready to go!</p>

Q37 and Q47 PROGRAM REFERENCE

Press Program (▲) or (▼) and Enter to choose a program.

Q37xi and Q47xi HEART RATE PROGRAMS

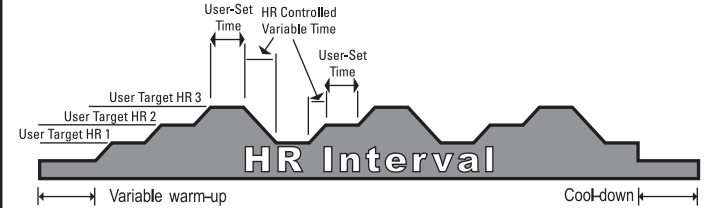
Programs & Standard Settings	Description
 <p>Fat Burn</p> <p>65% ———</p> <p>Variable warm-up ————— Cool-down</p> <p>Time (30:00) Stride (21"/52 cm) (Q47x/Q47xi) Age (40) Target (.65 * (220 - Age)) Weight (150 lbs./68kg)</p>	<p>Maximize the percentage of calories burned from fat versus carbohydrates with this controlled workout at 65% of theoretical maximum heart rate (or user-specified target heart rate). Use Level (▲) or (▼) to adjust interval target heart rates mid-workout.</p>
 <p>HR Interval</p> <p>User-Set Time HR Controlled Variable Time User-Set Time</p> <p>User Target HR 3 User Target HR 2 User Target HR 1</p> <p>Variable warm-up ————— Cool-down</p> <p>Time (30:00) Stride (21"/52 cm) (Q47x/Q47xi) Age (40) Intervals (2) Interval 1 — Time (00:30) Interval 1 — Target Heart Rate (.70* (220 - Age)) Interval n — Time (00:30) Interval n — Target Heart Rate (.70* (220 - Age)) Weight (150 lbs./68kg)</p>	<p>Build a custom heart-rate controlled workout of up to 4 alternating intervals of user-defined duration and target heart rates. Use Level (▲) or (▼) to adjust interval target heart rates mid-workout.</p>

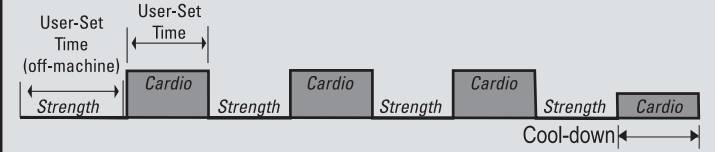
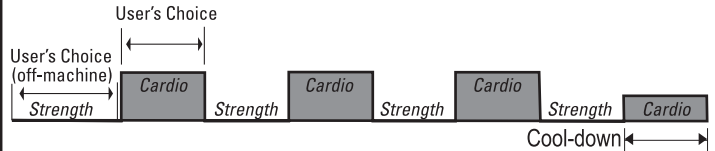

Q37 and Q47 CROSS CIRCUIT™ PROGRAMS

Programs & Standard Settings	Description
 <p>CROSS CIRCUIT Time</p> <p>User-Set Time (off-machine) Strength Cardio Strength Cardio Strength Cardio Strength Cardio</p> <p>Cool-down</p> <p>Time (30:00) Stride (21"/52 cm) (Q47x/Q47xi) Level (1) Cardio (2:00) Strength (1:00) Age (40) Weight (150 lbs./68kg)</p>	<p>Maximize the impact of your workout time with this challenging on-and off-machine cross-training routine. Set up the Cardio interval time, Strength interval time, and Level, complete your warm-up, then listen for the beeps to tell you when to step off the machine to complete your strength set. Create your own workout plan or, with your Q37xi or Q47xi, follow the suggestions of SMARTLINK App. The display will flash and you will hear another set of beeps when it is time to step back on the elliptical for your next cardio interval. This pattern continues throughout your workout. Use Level (▲) or (▼) to adjust the cardio interval resistance mid-workout.</p>
 <p>CROSS CIRCUIT Free</p> <p>User's Choice (off-machine) Strength Cardio Strength Cardio Strength Cardio Strength Cardio</p> <p>Cool-down</p> <p>Time (30:00) Stride (21"/52 cm) (Q47x/Q47xi) Level (1) Age (40) Weight (150 lbs./68kg)</p>	<p>Enjoy this free-form integration of on-machine cardio and off-machine strength exercises. You decide when to step off for a strength set (or, with your Q37xi or Q47xi, follow the instructor in the SMARTLINK App.) Step back on to start another cardio interval. Use Level (▲) or (▼) to adjust the cardio interval resistance mid-workout.</p>

Q37 and Q47 PROGRAM REFERENCE

Press Program (▲) or (▼) and Enter to choose a program.

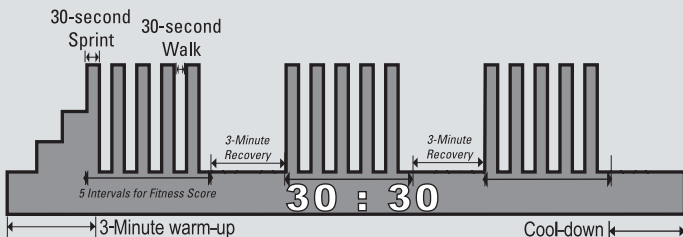
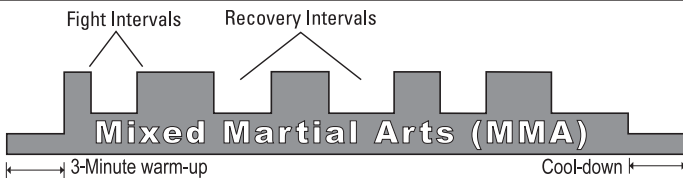
Q37xi and Q47xi ADVANCED PROGRAMS

Programs & Standard Settings	Description
 <p style="text-align: center;">30 : 30</p> <p style="text-align: center;">Time (30:00) Stride (21"/52 cm) (Q47x/Q47xi) Sprint Level (8) Age (40) Weight (150 lbs./68kg)</p>	<p>This challenging program provides a simple test of fitness level with 5 sets of 30-second sprint and recovery intervals. For each set, the program monitors heart rate and calculates the average minimum and average maximum heart rates and the average number of beats the heart rate recovers between sprint intervals. Heart rate recovery is a relative indicator of fitness level; a higher number indicates a more rapid heart rate recovery and therefore represents a relatively better level of fitness.</p>
 <p style="text-align: center;">Mixed Martial Arts (MMA)</p> <p style="text-align: center;">Rounds (3) Intensity (High) Stride (21"/52 cm) (Q47x/Q47xi) Age (40) Weight (150 lbs./68kg) Fight Level (6)</p>	<p>Take on your toughest opponent yet—the Octane elliptical! Battle it out in 5-minute rounds that include 5 alternating ‘fight’ and ‘recover’ intervals of various lengths. The harder you punch with your arms, the harder the Octane elliptical ‘fights back’ with increased resistance. This great workout gets your heart—and your fists—pumping!</p>
GOAL PROGRAMS	
 <p style="text-align: center;">Distance Goal</p> <p style="text-align: center;">Distance (10K) Stride (21"/52 cm) (Q47x/Q47xi) Level (5) Age (40) Weight (150 lbs./68 kg)</p>	<p>Complete a virtual race—a great way to train for an actual event. Take to the hills as gradual resistance changes simulate variance in terrain, replicating the challenges encountered when walking or running outside. The distance readout counts down from 6.2 miles (10 kilometers). Use Level (▲) or (▼) to adjust interval resistance mid-workout.</p>
 <p style="text-align: center;">Calorie Goal</p> <p style="text-align: center;">Calories (350) Stride (21"/52 cm) (Q47x/Q47xi) Level (1) Age (40) Weight (150 lbs./68 kg)</p>	<p>Get moving on a flat course until you have burned your target number of calories. Use Level (▲) or (▼) to adjust interval resistance mid-workout. Watch the calories fall away!</p>

Q37 and Q47 PROGRAM REFERENCE

Press Program (▲) or (▼) and Enter to choose a program.

Q47x and Q47xi STRIDE PROGRAMS

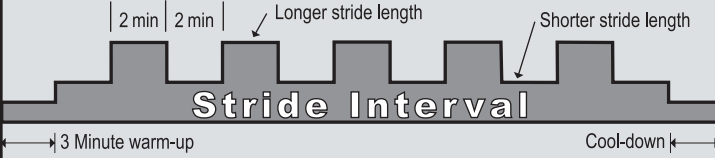
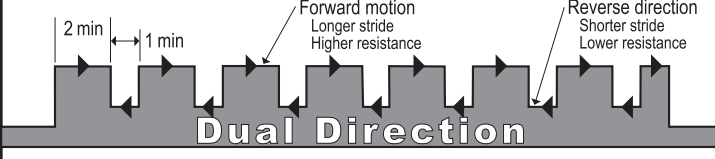
Programs & Standard Settings	Description
 <p>Stride Interval</p> <p>3 Minute warm-up 2 min 2 min Longer stride length Shorter stride length Cool-down</p> <p>Time (30:00) Long Stride (21"/52 cm) Short Stride (18"/46 cm) Level (1) Age (40) Weight (150 lbs./68 kg)</p>	<p>Strengthen and tone your legs with variety in muscle focus. This program alternates two-minute shorter stride intervals and longer stride intervals of uniform resistance. Use any (▲) or (▼) on the keypad to adjust stride length during the workout or to adjust the Level within an interval.</p>
 <p>Dual Direction</p> <p>3 Minute warm-up 2 min 1 min Forward motion (Longer stride, Higher resistance) Reverse direction (Shorter stride, Lower resistance) Cool-down</p> <p>Time (30:00) Forward Stride (21"/52 cm) Reverse Stride (18"/46 cm) Forward Level (4) Age (40) Weight (150 lbs./68 kg)</p>	<p>Add variety and interest as you alternate two-minute intervals of forward and lower-resistance backward motion. Feel the difference in your quads and glutes. Use any (▲) or (▼) on the keypad to adjust stride length during the workout or to adjust the Level within an interval.</p>

**Standard program values are used if no values are entered within 4 seconds of Message Center prompts.*

PRODUCT FEATURES

The Octane Fitness Q37 and Q47 ellipticals incorporate additional features to ensure that you experience great workouts, including electronically adjustable stride with SmartStride, HeartLogic Intelligence and MultiGrip handlebars.

Heart Rate Monitoring and HeartLogic Intelligence

The Q37 and Q47 ellipticals are equipped with state-of-the-art heart rate monitoring and control technologies that help you make the most of your training efforts. Both models include on-demand heart rate monitoring—just grasp the digital contact heart rate grip sensors on the stationary handlebars and your current heart rate is displayed on the console.

For even greater control of your workout, the Q37xi and Q47xi are also equipped with HeartLogic Intelligence, Octane Fitness' sophisticated yet easy to use heart rate control technology. This sophisticated solution provides the most accurate and effective workout possible using heart rate data captured by a wireless chest strap or the digital contact heart rate grip sensors on the handlebars.

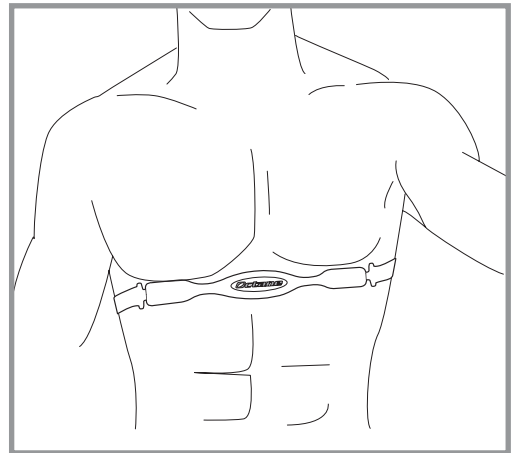

The Q37xi and Q47xi feature premium workouts designed to take full advantage of the benefits of heart rate zone training: Fat Burn, Heart Rate Interval and 30:30. The console displays time-in-zone, current heart rate, heart rate %, and target heart rate so you know exactly where you are and where you should be.

Using the digital contact heart rate sensors

The digital contact heart rate sensors are located on the stationary handlebars of the Q37x and Q37xi and on the Multigrip moving handlebars of the Q47x and Q47xi. The grips can be used to check your heart rate during your workout. For the most accurate heart rate reading possible, grasp each contact heart rate grip so that the contact sensor portion of the grip rests in the palm of your hand. Grip the contact sensors firmly, and keep your hands steady and in place.

Using a wireless chest strap (Q37xi, Q47xi)

The wireless chest strap transmits your heart rate to the electronics console at a distance of up to three feet. You may use any Polar™-compatible (coded or non-coded) transmitter. Adjust the length of the elastic strap and fasten the transmitter around your torso, underneath your shirt. Place the strap just below your chest. Make sure the logo is away from you and right side up. It may help to moisten the electrodes on the back of the transmitter with a small amount of water for better contact with the skin. The electrodes are the ribbed portion on the back side of the transmitter that sits against your skin. Make sure the strap fits snugly but doesn't restrict breathing. The contact handgrips reading takes priority if both the wireless and contact heart rate grips are in use.

Heart rate programs (Q37xi, Q47xi)

The Q37xi and Q47xi provide two heart rate controlled programs, Fat Burn and Heart Rate Interval, to offer you more variety to suit your personal needs. The 30:30 program also uses heart rate data to provide an assessment of heart rate recovery. We recommend that you try different programs to determine your favorite. Refer to the Program Reference chart for more information.

Electronically Adjustable Stride with SmartStride™ (Q47x and Q47xi)

The Q47 Series elliptical cross trainers are equipped with electronically adjustable stride, providing a custom fit for your body and your workout. Adjustable stride isn't just for fine-tuning the workout to your height – it custom fits your Octane cross trainer to your size and style and adds valuable variety.

By pressing the Stride (▲/▼) buttons on the console or the left moving handlebar, you can change the stride length from 18" (46 cm) to 26" (66 cm) in ½-inch (1 cm) increments. This added variety is great to use for different workouts, directions, warm-ups and cool-downs.

SmartStride™

Octane Fitness delivers the most advanced, ergonomically correct and inherently better elliptical cross training workouts ever with its proprietary SmartStride.

SmartStride automatically replicates natural movement by analyzing and measuring an exerciser's pace and direction and intuitively adjusting stride length from 18 inches (46 cm) to 26 inches (66 cm). These interactive ergonomics custom-fit the cross trainer to the exerciser for effective, comfortable, results-producing workouts unlike those on any other piece of fitness equipment.

To provide the most effective workouts on a cross trainer, the Octane design team spent years studying the biomechanics of different types of exercises, analyzing how the body moves naturally. This research, along with precise gait analysis, prototype testing and extensive user interviews, shows that stride length naturally varies according to an individual's height, leg length, flexibility, speed of travel and preference for lower or higher intensity motion.

Overall results indicated that:

Walking tends to use shorter strides

Jogging uses medium length strides

Running requires longer strides

Reverse motion shortens the stride length and shifts the torso lower and backward to increase stability and balance

Stride length preference changes with direction; exercisers prefer a longer motion for traveling forward and require a shorter motion in reverse.

In addition, research shows elliptical users tend to hold one pace steady throughout workouts, a pace that is matched to a fixed stride length. Researchers found that faster or slower speeds feel unnatural when stride lengths were not adjusted accordingly.

You will soon find that SmartStride is a valuable and integral component in providing the most effective workouts available.

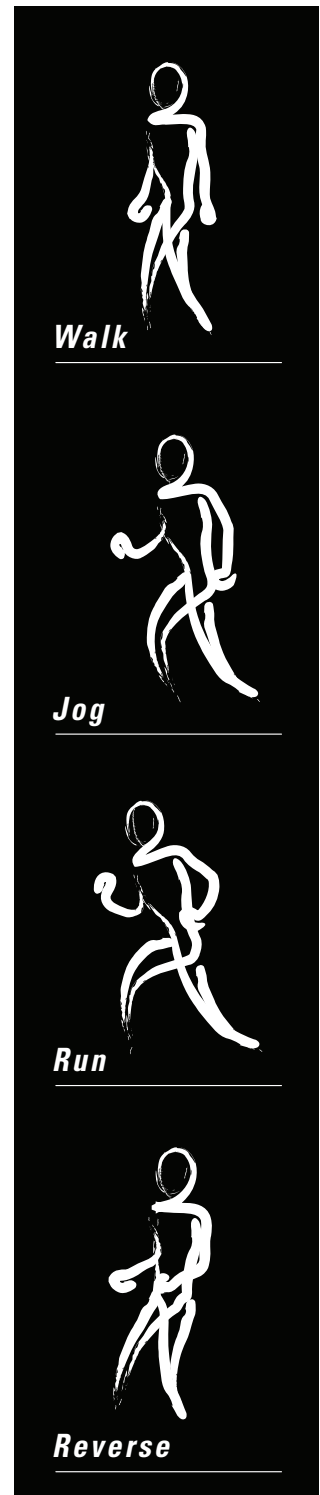

What Should My Stride Length Be?

The Q47 Series ellipticals offer Octane Fitness' unique size-based programming to help you find your optimum stride length for walking, jogging, and running. When you exercise at your perfect stride length, you can burn more calories, avoid injuries, and feel better during your workouts.

Octane's research has found that the distance from your hip socket joint through your knee to your heel is the most precise measurement to determine an appropriate stride length. We call this measurement your Hip Indexing Pivot (HIP) number. To find your HIP number, first move the right pedal back while pushing the right handlebar forward, stopping the handlebar in its forward-most position (Figure 1). Then stand next to the right handlebar and note the number on the HIP Ruler that is closest to your hip socket (Figure 2). Use this HIP number to find your optimum forward and reverse stride lengths in the table on the following page, or enter it into your elliptical using the SmartStride customization features described below to get a workout sized just for you!

Note: If it is not convenient for you to measure for your HIP number, you can also get an approximate HIP number, based on your height, from the table on the following page. This table also references your recommended SmartStride lengths.

Setting Your SmartStride Length for Your Workout

Once you have your HIP number and the corresponding optimum forward and reverse stride lengths, you can enter these values into your Octane elliptical at any time during your workout. On the **Q47xi**, you can also set these values as the default for your workout session using the SmartStride customization feature. Just press and hold the SmartStride button for three seconds and follow the prompts. This will ensure that you are working out with your optimum stride lengths throughout your entire session.

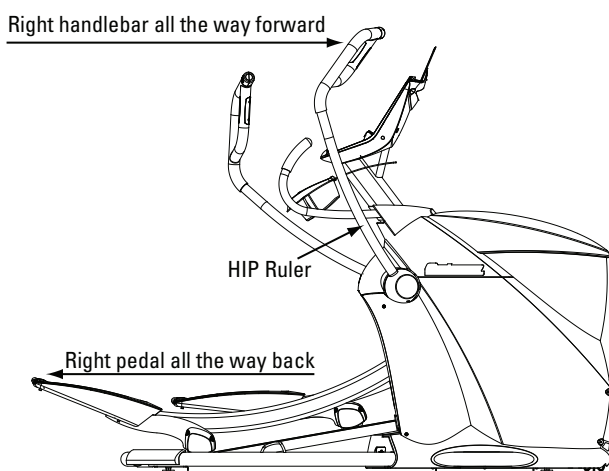

Figure 1

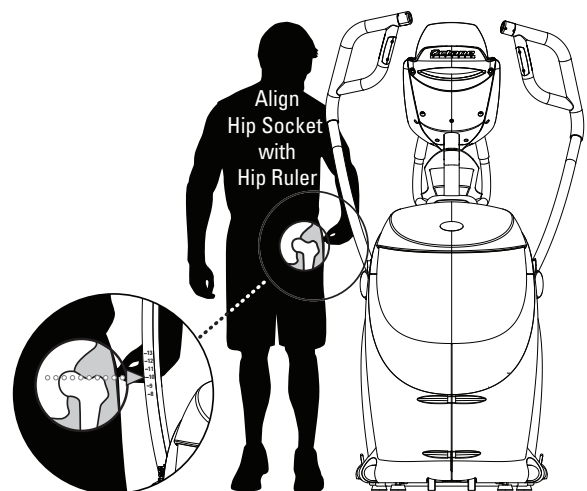

Figure 2

Find Your Perfect Stride Length

Hip Indexing Pivot	Approximate Height	WALK		JOG		RUN	
		Forward Stride	Reverse Stride	Forward Stride	Reverse Stride	Forward Stride	Reverse Stride
1	Under 5' (Under 152 cm)	18 in. (46 cm)	18 in. (46 cm)	19 in. (48 cm)	18 in. (46 cm)	20.5 in. (52 cm)	18 in. (46 cm)
2 - 3	5'0" to 5'1" (152 to 155 cm)	18.5 in. (47 cm)	18 in. (46 cm)	19.5 in. (50 cm)	18 in. (46 cm)	21 in. (53 cm)	18 in. (46 cm)
4 - 5	5'1" to 5'3" (155 to 160 cm)	19.5 in. (50 cm)	18 in. (46 cm)	20.5 in. (52 cm)	18 in. (46 cm)	22 in. (56 cm)	19 in. (48 cm)
6 - 7	5'3" to 5'5" (160 to 165 cm)	20 in. (51 cm)	18 in. (46 cm)	21 in. (53 cm)	18 in. (46 cm)	22.5 in. (57 cm)	19.5 in. (50 cm)
8 - 9	5'5" to 5'8" (165 to 173 cm)	20.5 in. (52 cm)	18 in. (46 cm)	21.5 in. (55 cm)	18.5 in. (47 cm)	23 in. (58 cm)	20 in. (51 cm)
10 - 11	5'8" to 5'10" (173 to 179 cm)	21 in. (53 cm)	18 in. (46 cm)	22 in. (56 cm)	19 in. (48 cm)	23.5 in. (60 cm)	20.5 in. (52 cm)
12 - 13	5'10" to 6'0" (179 to 183 cm)	21.5 in. (55 cm)	18.5 in. (47 cm)	22.5 in. (57 cm)	19.5 in. (50 cm)	24 in. (61 cm)	21 in. (53 cm)
14 - 15	5'11" to 6'2" (180 to 188 cm)	22 in. (56 cm)	19 in. (48 cm)	23 in. (58 cm)	20 in. (51 cm)	24.5 in. (62 cm)	21.5 in. (55 cm)
16 - 17	6'0" to 6'4" (183 to 193 cm)	22.5 in. (57 cm)	19.5 in. (50 cm)	23.5 in. (60 cm)	20.5 in. (52 cm)	25 in. (64 cm)	22 in. (56 cm)
18 - 19	6'3" to 6'6" (191 to 198 cm)	23 in. (58 cm)	20 in. (51 cm)	24 in. (61 cm)	21 in. (53 cm)	25.5 in. (65 cm)	22.5 in. (57 cm)
20	Over 6'5" (Over 196 cm)	23.5 in. (60 cm)	20.5 in. (52 cm)	24.5 in. (62 cm)	21.5 in. (55 cm)	26 in. (66 cm)	23 in. (58 cm)

Note: The Approximate Height column above is provided only as a rough guide for you to use when it is not convenient to use the HIP Ruler as described in "What Should My Stride Length Be?"

ENJOY YOUR OCTANE FITNESS ELLIPTICAL

Our customer service team is available to answer any questions you may have about your Octane Fitness elliptical. Please join us in a 'live' chat at www.octanefitness.com, or call 1-888-OCTANE4 or 763-757-2662, ext. 1.

And don't forget to Fuel Your Workout on the Q37xi or Q47xi by downloading the free SMARTLINK by Octane Fitness for your iPad!

Join the **OCTANE FITNESS** Community.



search: Octane Fitness

Free Downloads, Workout Inspiration, Team Atmosphere



F U E L Y O U R L I F E TM

Octane Fitness

US & Canada, Latin America, Asia & Asian Pacific

7601 Northland Drive North

Suite 100

Brooklyn Park, MN 55428

Phone: 888.OCTANE4 (US and Canada)

763.757.2662 (Latin America, Asia and Asian Pacific)

Fax: 763.323.2064

Octane Fitness International

Europe, Middle East, Africa

Rivium Westlaan 19

2909 LD, Capelle a/d IJssel

The Netherlands

Phone: +31 10 2662412

Fax: +31 10 2662444

©2013 Octane Fitness, LLC. All rights reserved. Octane Fitness, DedicatedLogic, Fuel Your Life, HeartLogic, SMARTLIGHT, SMARTLINK, X-Mode, ArmBlaster, GluteKicker, and SmartStride are registered trademarks of Octane Fitness. Any use of these trademarks, without the express written consent of Octane Fitness, is forbidden. iTunes, iPad, iPod and iPhone are trademarks of Apple Inc., registered in the U.S. and other countries. Bluetooth is a registered trademark of the Bluetooth SIG. ANT+ is a registered trademark of ANT Wireless.

107951-001 REV A