



Gebruikershandleiding

BW03



Barcodescanner - BW03 Draadloos / Bluetooth

 : 0645733500

 : info@diwolar.nl

 : <https://www.dtronic.nl/>

Datum : 25-6-2020

Versie : 1.0

Voorwoord

Bedankt voor het vertrouwen in een product van DTRONIC.

Lees de inhoud van de gebruikershandleiding zorgvuldig door om de producten veilig en effectief te gebruiken. U wordt geadviseerd om deze handleiding correct te bewaren voor uw installatie en als naslagwerk.

Gelieve het product niet te demonteren of het zegel eraf te scheuren, anders bieden we geen garantie of vervangende service. De afbeeldingen in deze gebruikershandleiding zijn alleen ter referentie. Als er afbeeldingen zijn die niet overeenkomen met het daadwerkelijke product, neem dan het daadwerkelijke product als standaard. Bijgewerkte informatie kan zonder voorafgaande kennisgeving worden gewijzigd.

Alle informatie in deze handleiding is auteursrechtelijk beschermd en ons bedrijf behoudt zich alle rechten voor. Het is verboden om deze handleiding geheel of gedeeltelijk uit te delen, te kopiëren, te bundelen of zonder schriftelijke toestemming van ons te verkopen.

DTRONIC is een BOIP geregistreerd merk en in samenwerking met GS1 juridisch beschermd. Diwolar is het enige bedrijf met de rechten om dit merk op de markt te brengen. Heeft u een product aangeschaft dat niet via Diwolar is gekocht dan vervalt de garantie. Bij contact met de klantenservice vragen wij u altijd naar het bestelnummer.

Deze gebruikershandleiding is van toepassing op DTRONIC barcodescanners die streepjescodes identificeren met behulp van een laserscanpatroon.

INHOUDSOPGAVE

VOORWOORD	2
1. HET PRODUCT	5
1.1 Hoofdfuncties van deze scanner	5
1.2 Pak het apparaat uit	5
1.3 Opstarten, afsluiten en opnieuw opstarten	5
1.4 Onderhoud.....	5
1.5 Leesvaardigheden.....	6
1.6 Uitstraling van het apparaat.....	6
1.7 Led indicator	7
1.8 Koppelen met bluetooth	7
2. SYSTEEM-INSTELLINGEN	8
2.1 Fabrieksinstelling.....	8
2.2 Instellen van barcodes.....	8
2.2.1 Normale instelling	8
2.2.2 Koppelen.....	8
2.2.3 Opslag instelling	9
2.2.4 Versie instelling	9
2.2.5 Bluetooth instelling	9
2.2.6 Stappen om Bluetooth naam in te stellen	10
2.3 IOS toetsenbord.....	11
2.4 Eind karakters	11
2.5 Prefix / suffix.....	11
2.6 Volume instellingen	12
2.7 Overdrachtssnelheid.....	13
2.8 Time-out	13
2.9 Landinstellingen.....	14
2.10 Trigger mode.....	14
2.11 EAN instellingen.....	15
2.11.1UPC-A.....	15
2.11.2UPC-E	15
2.11.3EAN-8.....	15
2.11.4EAN-13.....	15
2.11.5Bookland EAN (ISBN)	15
2.11.6UPC / EAN	16
2.11.7Code-128	16
2.11.8Code GS1-128	16
2.11.9Code-39	16
2.11.10 Code-93	16
2.11.11 Code-11	17
2.11.12 ITF25	17
2.11.13 Codabar	17
2.11.14 MSI.....	17
2.11.15 Databar RSS 14	17
2.11.16 PDF417.....	17
2.11.17 Data Matrix.....	18
2.11.18 Maxi Code.....	18
2.11.19 Aztec	18

2.12	Overzicht prefix en suffix symbolen	19
3.	AFSLUITING.....	26

1. Het product

1.1 Hoofdfuncties van deze scanner

- Werkt met Plug&Play en zonder installatiesoftware.
- Werkt met de meeste WMS systemen.
- Sommige WMS of kassasystemen moeten worden ingesteld op het gebruik van een scanner.
- Device waar de scanner op aangesloten is zal deze zien als toetsenbord.
- In de basis scant de scanner de 95% van de barcodes, overige 5% kan naar wens ingesteld worden met deze handleiding.
- Er zitten gepatenteerde onderdelen in de scanner, DTRONIC heeft de rechten om deze artikelen te verkopen op de Nederlandse, Belgische en Duitse markt.

1.2 Pak het apparaat uit

Nadat u de doos met het product hebt geopend, voert u de volgende stappen uit:

- Haal de accessoires voor de scanner uit de verpakking.
- Haal de scanner uit de verpakking.
- Controleer bij de paklijst of alles compleet en in goede staat is. Als er beschadigde of ontbrekende onderdelen zijn, bewaar dan de originele verpakking en neem contact op met DTRONIC voor de klantenservice.

Paklijst:

1. Handscanner
2. USB Aansluitkabel (bij draadloze scanners is dit de oplaadkabel)
3. CD-rom en bluetooth connector
4. Verkorte gebruikershandleiding

1.3 Opstarten, afsluiten en opnieuw opstarten

Opstarten: verbind de computer met de scanner. De computer zal hem herkennen als toetsenbord en de scanner kan gebruikt worden.

Uitschakelen: verwijder de kabel die is verbonden met de scanner; verwijder de USB die op de computer is aangesloten.

Opnieuw opstarten: als de scanner crasht of niet reageert, schakel hem dan uit en start hem opnieuw op. Eventueel kan de fabrieksinstelling uit deze handleiding gebruikt worden.

1.4 Onderhoud

Het scanvenster moet schoon worden gehouden, de leverancier draagt niet de garantieverantwoordelijkheid als gevolg van onjuist onderhoud. Voorkom dat het raam verslijft of wordt bekrast door een hard voorwerp. Gebruik een zachte doek om de vlek op het scanvenster te verwijderen. Reinig het scanvenster met een zachte doek, zoals een lensreinigingsdoekje. Sproeien van vloeistof op het scanvenster is verboden. Verbied alle reinigingsoplosmiddelen, behalve het reinigingswater.

1.5 Leesvaardigheden





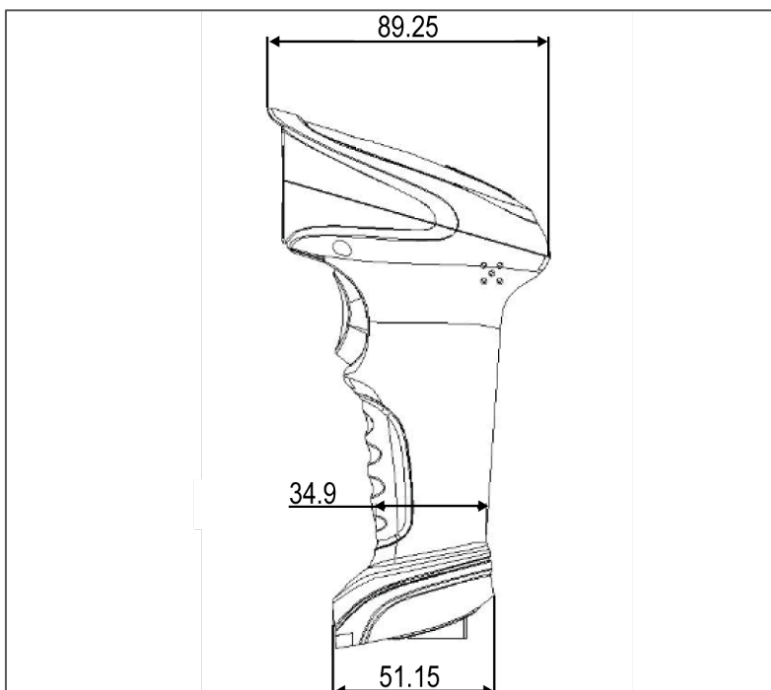
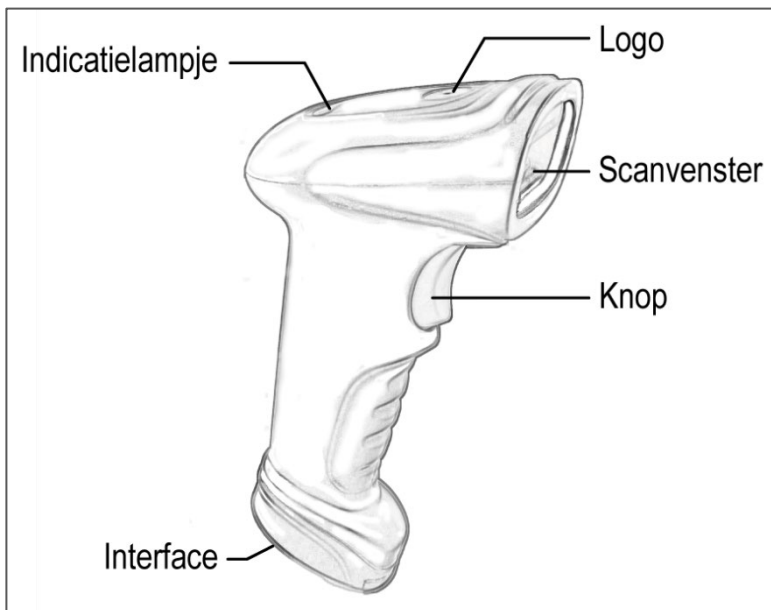

Als de streepjescode klein is, moet deze dicht bij het scanscanvenster liggen; als de streepjescode groot is, moet deze verder van het scanscanvenster verwijderd zijn, zodat deze gemakkelijker leesbaar is.

Als de streepjescode sterk reflecteert (bijvoorbeeld het gecoate oppervlak), moet u de streepjescode mogelijk schuin kantelen om de streepjescode te scannen. De beste afstand om een barcode te lezen is 10-15 cm.

1.6 Uitstraling van het apparaat



1.7 Led indicator

	INDICATOR STATUS	EXPLAIN
	Red light on	Charging
	Red light off	No charging
	Green light on	No decoding
	Green light off	Decode succesfully
	One blue light on	Pairing successful or connect to USB
	Two blue light twinkle alternately	Bluetooth HID pair mode

1.8 Koppelen met bluetooth

1. Druk op de knop van de scanner, de scanner springt aan en er verschijnt een groene lamp.
2. Sluit de USB connector aan op de computer of laptop, wacht enkele ogenblikken tot de computer hem heeft gevonden en daadwerkelijk ziet.
3. Klik onderin de balk met de rechtermuisknop op het bluetooth icoon.
4. Kies: Deelnemen aan PAN.
5. Zet de scanner in de aansluitmodus, door 8 seconden de scan knop ingedrukt te houden.
6. Kies: Apparaat toevoegen aan PAN.
7. Computer vindt de scanner als toetsenbord en staat nu in de lijst van aangesloten apparaten.
8. Zet nogmaals de scanner in aansluitmodus door 8 seconden de knop ingedrukt te houden.
9. De scanner maakt verbinding en alles werkt.

2. Systeem-instellingen

Optie- en functie-instelling voornamelijk door het lezen van een reeks speciale barcodes. In dit hoofdstuk geven we u een gedetailleerde introductie van de opties en functies die beschikbaar zijn voor gebruikersinstellingen en de bijbehorende instellingscode.

Deze methode voor het instellen van de scan is direct, gemakkelijk te begrijpen en gebruiksvriendelijk.

2.1 Fabrieksinstelling



2.2 Instellen van barcodes

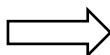

Enter Setting

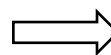

Barcode Setting

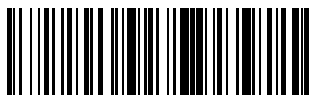

Exit Setting

	
Enter setting	Exit setting
	
Fabrieksinstelling	

2.2.1 Normale instelling

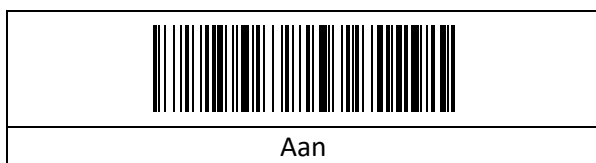

2.2.2 Koppelen

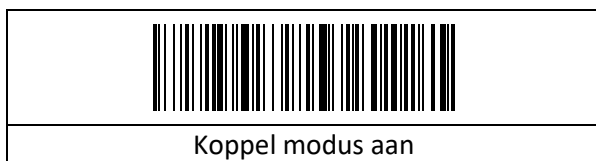

2.2.3 Opslag instelling

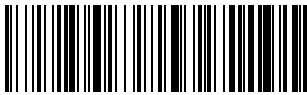
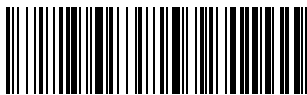
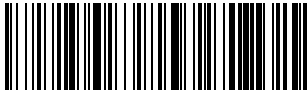
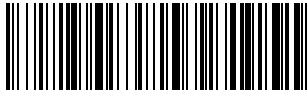
	
Opslag instelling	Upload data
	
Display stored barcode	Geheugen legen

2.2.4 Versie instelling

Versie informatie

2.2.5 Bluetooth instelling

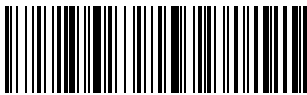
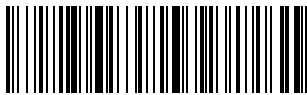
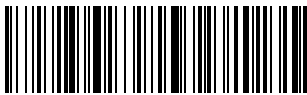
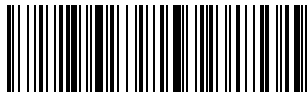
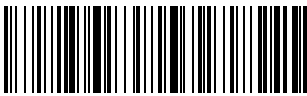
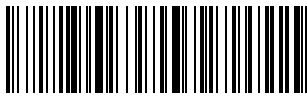
	
Bluetooth HID mode(default)	Bluetooth SPP mode
	
Virtual Bluetooth mode	Bluetooth BLE mode
	
Bluetooth name setting	Read Bluetooth name

2.2.6 Stappen om Bluetooth naam in te stellen

Scan eerst de "Bluetooth-naaminstelling" en scan vervolgens nog een streepjescode die de Bluetooth-naam van deze scanner wordt.

**OPMERKING:**

De langste Bluetooth-naam kan 16 bytes zijn. Als de streepjescode van de Bluetooth meer dan 16 bytes is, neemt de Bluetooth alleen de eerste 16 bytes als Bluetooth-naam.

**OPMERKING:**

Volledig Bluetooth-naamindeling, waaronder: Bluetooth-naam + protocoltype, kunt u alleen de Bluetooth-naam wijzigen. Nadat u de Bluetooth-naam hebt gewijzigd, worden alle Bluetooth-namen met een ander protocoltype tegelijkertijd gewijzigd. U kunt bijvoorbeeld de Bluetooth-naam in "HID-modus" in "Scanner" wijzigen, waarna de Bluetooth-naam "ScannerHID" wordt. In het SPP- en BLE-protocol is dit "ScannerSPP" en "ScannerBLE".

HID-koppelingsstap 1:

1. Na activatie blijft het groen lampje van de scanner altijd aan;
2. Scan "Enter Setting" >> "Pair Mode" >> "Bluetooth HID-modus" >> "Exit Setting"
3. Nu blijft groen aan en twee blauwe lichtjes knipperen afwisselend.
4. Wanneer het blauwe en groene lampje branden en de buzzer klinkt, is het koppelen gelukt.

HID-koppelingsstap 2:

1. Na activatie blijft het groen lampje van de scanner altijd aan;
2. Druk op de knop voor 8S
3. Nu blijft groen aan en twee blauwe lichtjes knipperen afwisselend.
4. Wanneer het blauwe en groene lampje branden en de buzzer klinkt, is het koppelen gelukt.

SPP-koppelingsstap:

1. Na activatie blijft het groen lampje van de scanner altijd aan;
2. Scan "Enter Setting" >> "Pair Mode" >> "Bluetooth SPP-modus" >> "Exit Setting"
3. Nu blijft groen aan en twee blauwe lichtjes knipperen afwisselend.
4. Wanneer het blauwe en groene lampje branden en de buzzer klinkt, is het koppelen gelukt.

BLE-koppelingsstap:

1. Na activatie blijft het groen lampje van de scanner altijd aan;
2. Scan "Enter Setting" >> "Pair Mode" >> "Bluetooth BLE-modus" >> "Exit Setting"
3. Nu blijft groen aan en twee blauwe lichtjes knipperen afwisselend.
4. Wanneer het blauwe en groene lampje branden en de buzzer klinkt, is het koppelen gelukt.

**OPMERKING:**

Dubbelklik op de knop tijdens de verbinding verlaat de "Koppelmodus"; als de koppeling niet binnen een minuut tot stand komt, wordt "Koppelmodus" afgesloten.

2.3 IOS toetsenbord

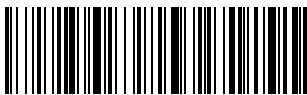
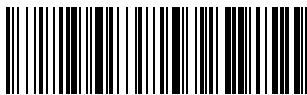
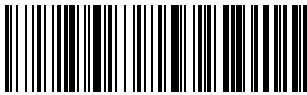









	
popup/hide HID keyboard	CLOSE double click popup/hide HID keyboard
	
OPEN double click popup/hide HID keyboard (default)	

2.4 Eind karakters





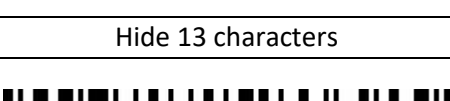
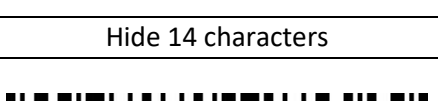

	
Enter (CR)	Line feed (LF)
	
Enable CRLF as ending character (default)	Disable CRLF as ending character

2.5 Prefix / suffix

	
Add prefix	Add suffix
	
Hide prefix	Hide suffix
	
Hide 1 character	Hide 2 characters
	
Hide 3 characters	Hide 4 characters

	
Hide 5 characters	Hide 6 characters
	
Hide 7 characters	Hide 8 characters
	
Hide 9 characters	Hide 10 characters
	
Hide 11 characters	Hide 12 characters
	
Hide 13 characters	Hide 14 characters
	
Hide 15 characters	Hide 16 characters

2.6 Volume instellingen



	
Laag	Middel
	
Hoog (default)	Uit
	
Buzzer Frequency 2K	Buzzer Frequency 2.7K (default)

2.7 Overdrachtssnelheid





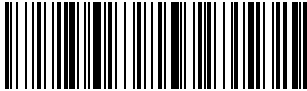
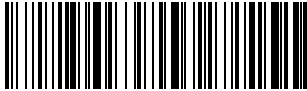



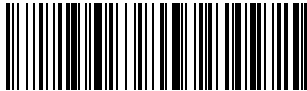
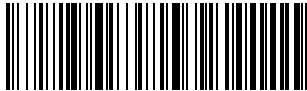

OPMERKING:







Alleen gebruiken als u een verouderde langzame PC heeft waaraan de scanner is gekoppeld.

	
Hoog	Middel
	
Laag	Extra laag



2.8 Time-out

	
30 seconden	1 minuut
	
2 minuten	5 minuten
	
10 minuten	30 minuten
	
Geen time-out	Direct na iedere scan
	
Display batterij	

2.9 Landinstellingen



	
English (default)	German (Germany)
	
French (France)	Spanish (Spain)
	
Italian (Italy)	Japanese (Japan)
	
International General Keyboard	

2.10 Trigger mode



Scan (pulse)

Permanent aan

Auto mode

2.11 EAN instellingen



2.11.1 UPC-A

 ZM092	 ZM09A
Aan	Uit



2.11.2 UPC-E

 ZM0A2	 ZM0AA
Aan	Uit





2.11.3 EAN-8

 ZM070	 ZM076
Aan	Uit



2.11.4 EAN-13

 ZM07C	 ZM082
Aan	Uit



2.11.5 Bookland EAN (ISBN)

 ZM08C	 ZM08F
Aan	Uit
 ZM090	 ZM08D
Bookland ISBN-10	Bookland ISBN-13



2.11.6 UPC / EAN

	
Disable identify UPC/EAN Addendum Code	Only identify UPC/EAN with addendum code
	
Auto identify UPC/EAN Addendum code	

2.11.7 Code-128

	
Aan	Uit

2.11.8 Code GS1-128

	
Aan	Uit



2.11.9 Code-39

 ZMOB2	 ZMOB7
Aan	Uit



2.11.10 Code-93

 ZMOCA	 ZMOCD
Aan	Uit



2.11.11 Code-11

 ZMOD0	 ZMOD3
Aan	Uit

2.11.12 ITF25

 ZMOE2	 ZMOE5
Aan	Uit



2.11.13 Codabar

 ZMOD6	 ZMOD8
Aan	Uit



2.11.14 MSI

 ZMODA	 ZMODE
Aan	Uit



2.11.15 Databar RSS 14

 Aan	 Uit
--	---



2.11.16 PDF417

 Aan	 Uit
--	---



2.11.17 Data Matrix

	
Aan	Uit







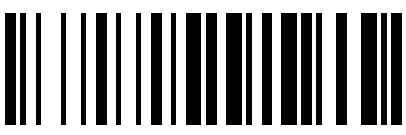
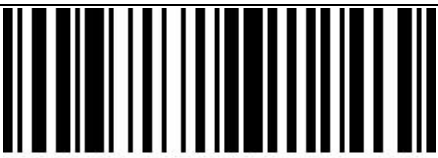
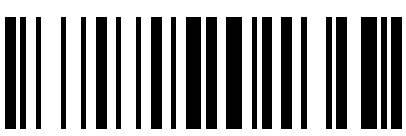
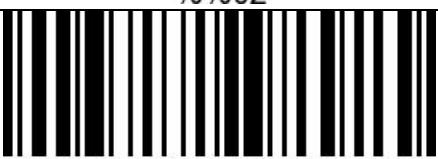
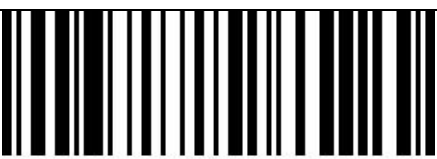
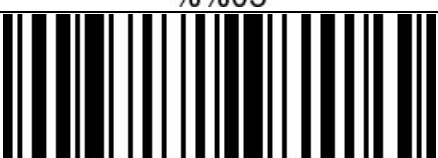
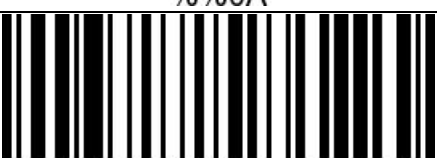

2.11.18 Maxi Code

	
Aan	Uit

2.11.19 Aztec

	
Uit	Aan

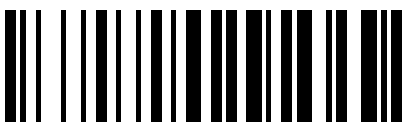
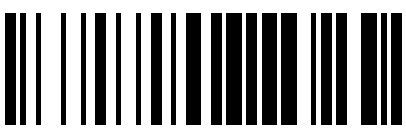
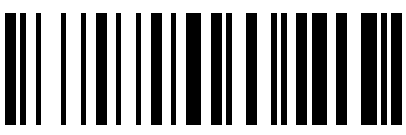
2.12 Overzicht prefix en suffix symbolen

1	SOH	 %%01	8	Back Space	
2	STX	 %%02	9	Tab	
3	ERX	 %%03	10	LF	 %%0A
4	EOT	 %%04	11	VT	 %%0B
5	ENQ	 %%05	12	FF	 %%0C
6	ACK	 %%06	13	CR	 %%0D
7	BEL	 %%07	14	F1	
15	F2		23	F10	
16	F3		24	F11	

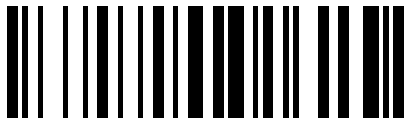
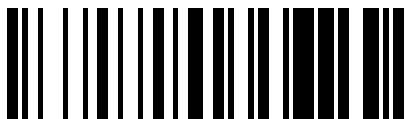
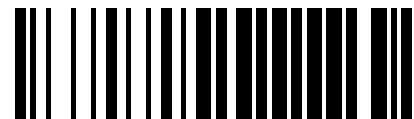
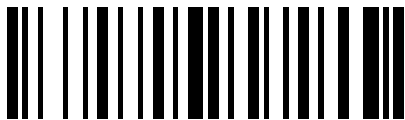
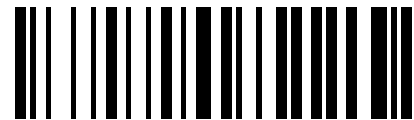
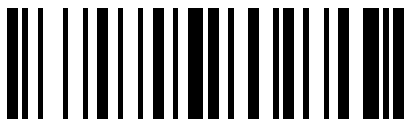
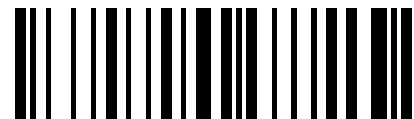
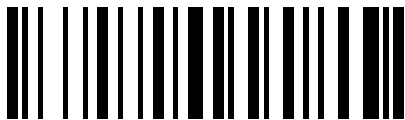
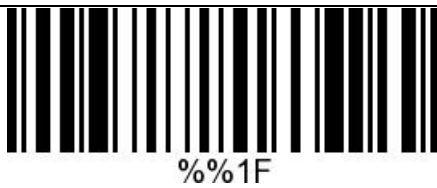
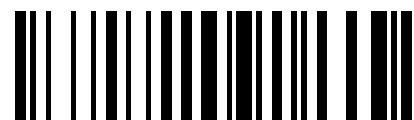
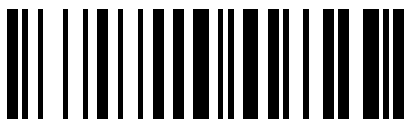
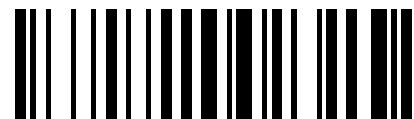
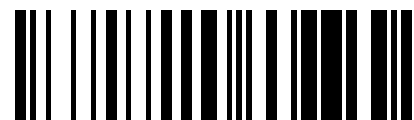
17 **F4**25 **F12**18 **F5**26 **SUB**19 **F6**27 **Esc**20 **F7**28 **FS**21 **F8**29 **GS**22 **F9**30 **RS**31 **US**39 **'**32 **空格**40 **(**33 **!**41 **)**34 **"**42 *****

35 #

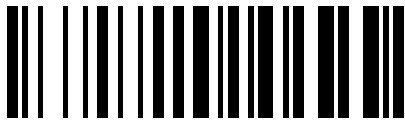

43 +

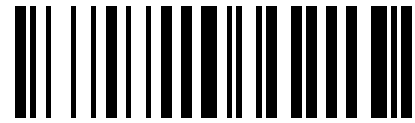

36 \$



44 ,

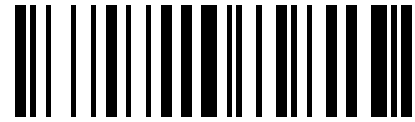

37 %

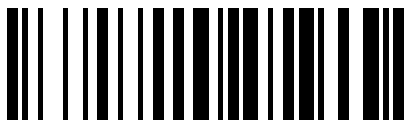

45 -

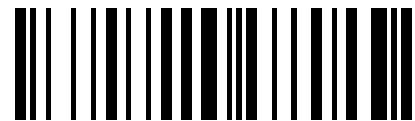

38 &

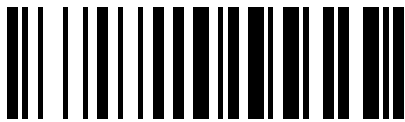

46 .

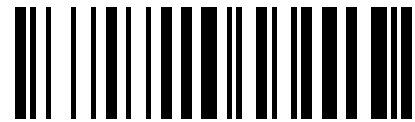

47 /

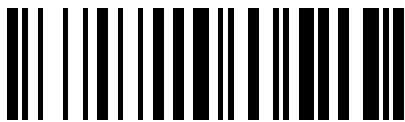

55 7

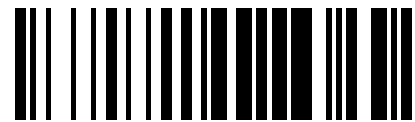

48 0

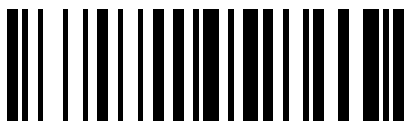

56 8

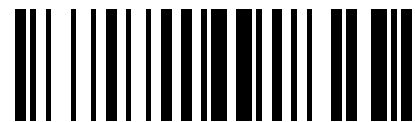

49 1

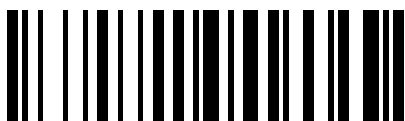

57 9

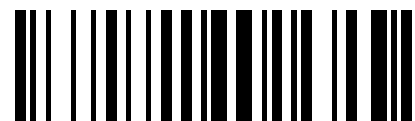

50 2



58 :

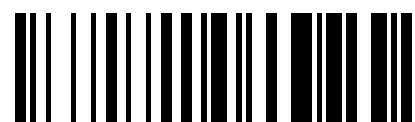

51 3



59 ;

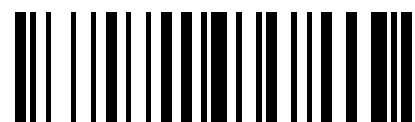

52 4

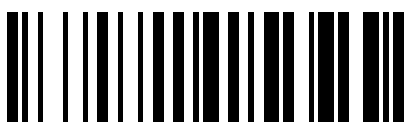

60 <

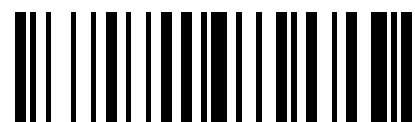

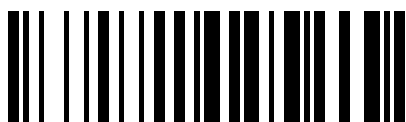
53 **5**



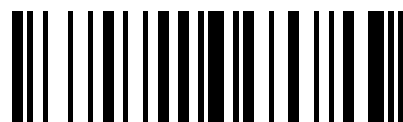
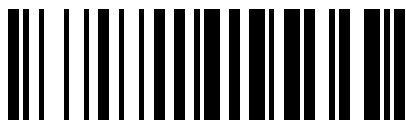



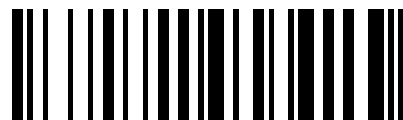
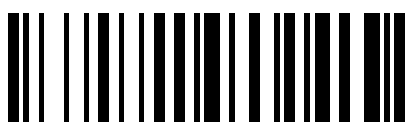
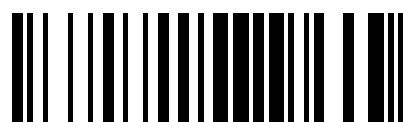
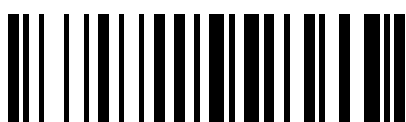
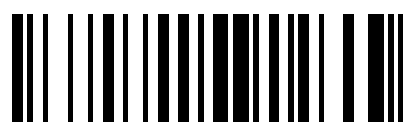
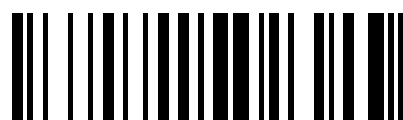
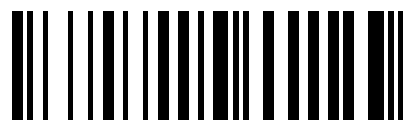
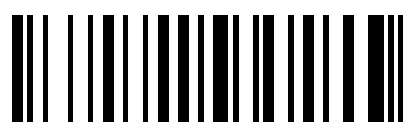
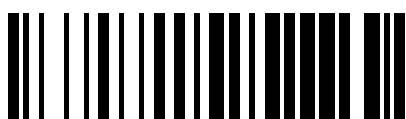
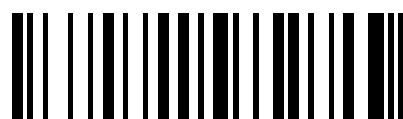
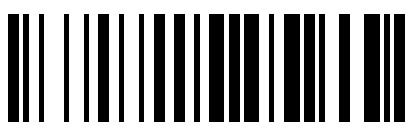
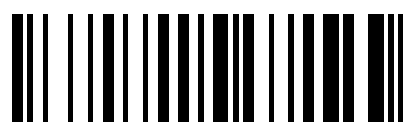
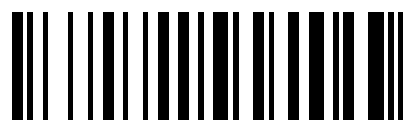

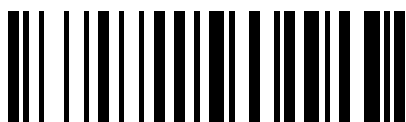
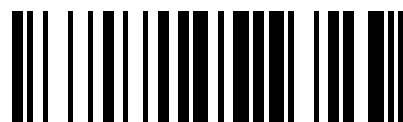
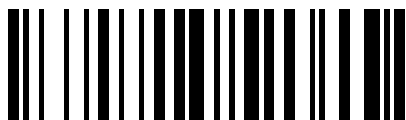
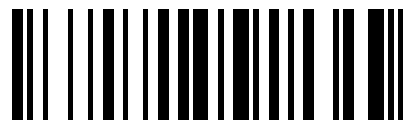
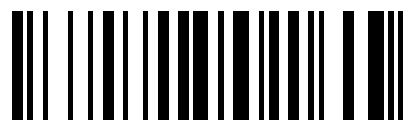
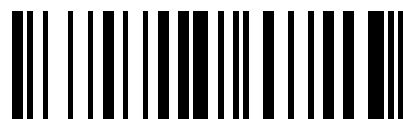
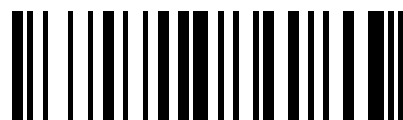
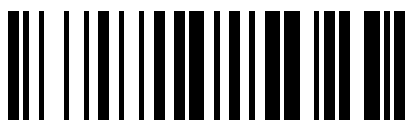
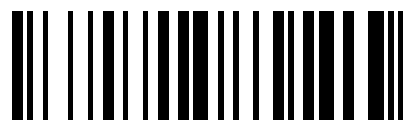
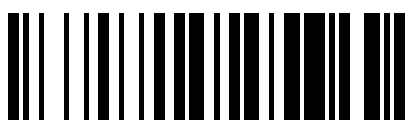
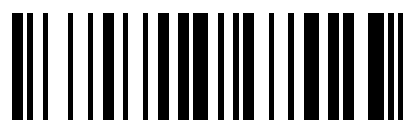
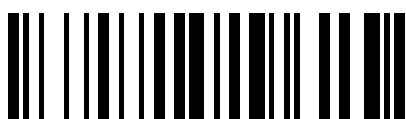
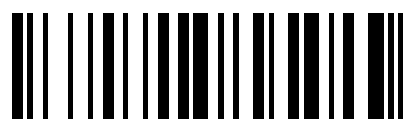
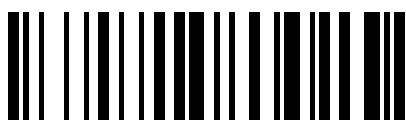
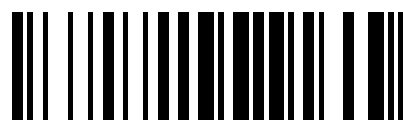
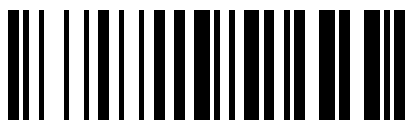
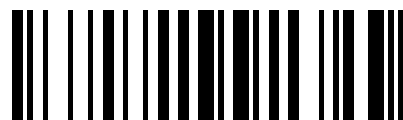

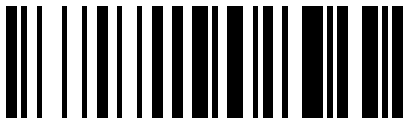
61 =

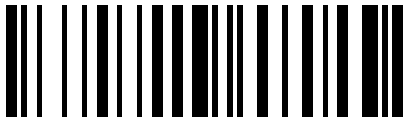
54 **6**

62 >

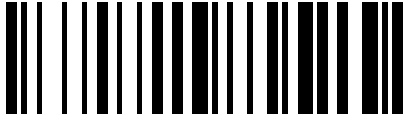
63 **?**71 **G**64 **@**72 **H**65 **A**73 **I**66 **B**74 **J**67 **C**75 **K**68 **D**76 **L**69 **E**77 **M**70 **F**78 **N**

79 **O**87 **W**80 **P**88 **X**81 **Q**89 **Y**82 **R**90 **Z**83 **S**91 **[**84 **T**92 ****85 **U**93 **]**86 **V**94 **^**95 **_**10
3 **g**96 **`**10
4 **h**

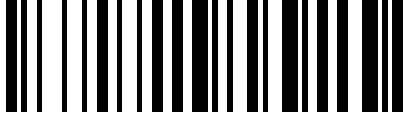
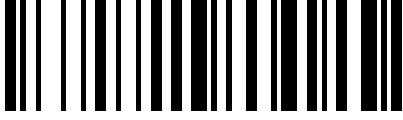
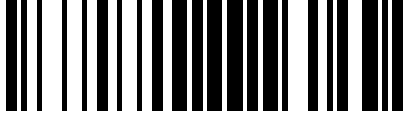
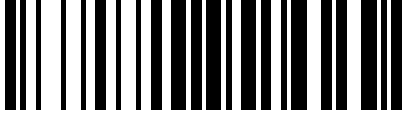
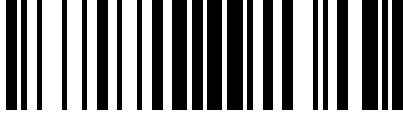
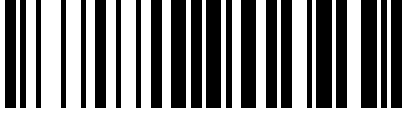
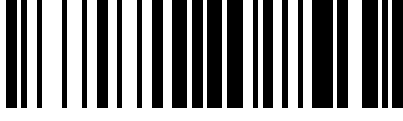
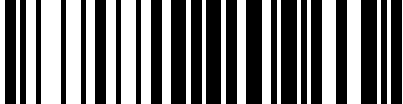
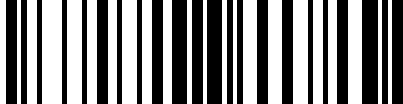
97	a		10 5	i	
98	b		10 6	j	
99	c		10 7	k	
10 0	d		10 8	l	
10 1	e		10 9	m	
10 2	f		11 0	n	
11 1	o		11 9	w	
11 2	p		12 0	x	
11 3	q		12 1	y	
11 4	r		12 2	z	

11 5	s		12 3	{	
11 6	t		12 4		
11 7	u		12 5	}	
11 8	v		12 6	~	
12 7	DEL				

3. Afsluiting

DTRONIC is niet aansprakelijk voor de geleden schade en defecten wanneer de barcodescanner niet werkt, niet naar behoren werkt of verkeerd gebruikt wordt. Bovenstaande informatie is een samenvatting van diverse bronnen op internet en kan wellicht de gebruiker ondersteunen.

DTRONIC

WWW.DTRONIC.NL

DTRONIC[®]

DTRONIC is een eigen (BOIP-geregistreerd) merk en onderdeel van de overkoepelende organisatie Diwolar. Voor meer informatie neem contact op met info@diwolar.nl
K.V.K 67621341

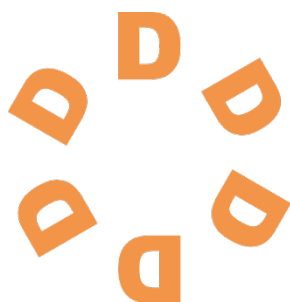
**DIWOLAR**