



Versatile manual backpack sprayer with 12 and 16 litre capacity respectively. Its stainless steel handle guarantees a reliable and long-lasting operation. It includes a selection of nozzles that allows different types of application. Sprayer suitable for use in large gardens.



Advantages

- Greater strength and performance to agrochemicals thanks to the robustness of the seal and the stainless steel handle.
- Maintenance without tools.
- Possibility of mixing inside the tank thanks to the translucent liquid level indicator.
- Homogeneous treatment thanks to the pressure regulator.
- Ambidextrous and lightweight keeping the ergonomics .
- Suitable for application of products of natural origin (pelargonicon, acetic, etc...).



Technical information

Technical information	EVOLUTION 12	EVOLUTION 16
HOSE	1,3 m (PVC)	
STANDARD NOZZLES	Adjustable conical	
LANCE	Fibreglass (71 cm)	
USABLE CAPACITY	12 L	16 L
TOTAL CAPACITY	13,3 L	17,7 L
LITRES/MIN. 1,5 BAR	0,56 l/min	
LITRES/MIN. 3 BAR	0,80 l/min	
NET WEIGHT	3,4 Kg	3,54 Kg
INTEGRATED SYSTEM TO RELEASE THE CYLINDER WITHOUT EMPTYING	YES	
WIDE FILLER OPENING	YES	
SET OF NOZZLES FOR HERBICIDE AND INSECTICIDE TREATMENTS	YES	
REINFORCED PRESSURE CHAMBER	YES	
TRANSLUCENT LEVEL INDICATOR	YES	
STANDARD ACCESSORIES	Pressure regulator, set of nozzles (herbicide elbow plus fan, mirror and disc nozzles), two seals (1 rubber and 1 synthetic) and a dispenser	
LANCE AND EXTENSIONS	Lance/Lever	
STRAPS	Adjustable and padded	
CHAMBER SEAL	Synthetic	FPM
PRESSURE REGULATOR	YES (3 positions)	
HANDLE	Stainless steel	

Logistics data

Logistics Data	EVOLUTION 12	EVOLUTION 16
CODE	8.49.49	8.49.41
EAN	84.14685.20109.6	84.14685.20094.5
CONDITIONING	1 unit	
UNITS PER PALLET	18 units	
DIMENSIONS PER PALLET	1200 X 800 X 1180	

MAINTENANCE KITS



PR MAINTENANCE KIT
Reference 8.39.41.870
Keep your sprayer at peak performance. Designed for 12-20 L sprayers.

ROUND SEAL AN-8 No. 101	2.23.15.908
STAINLESS STEEL BALL Ø 12 No. 119	2.20.08.902
VITON SEAL No. 120	8.39.11.305
ROUND SEAL AN-5 No. 136	2.23.15.905
CHAMBER VALVE No. 365	8.39.41.303
FILTER WASHER No. 1034	8.49.41.410



Functional information



Stainless steel handle



Pressure regulator



Ergonomic and robust clamping nut



Lance/lever support



Integrated system to release the cylinder without emptying



Reinforced chamber with synthetic retainer (Evolution 12) and FPM retainer (Evolution 16) for intensive use



Integrated and comfortable transport handle

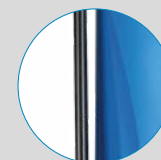

Stainless steel lance

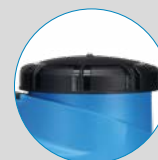

Large filling opening

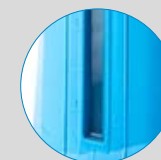

Translucent liquid level indicator

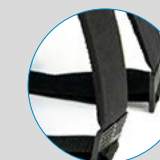

Adjustable padded straps



ACCESSORIES

Personalize your sprayer adapting it to your application needs (height, hard-to-reach areas...)



3.2 M TELESCOPIC LANCE
Reference 8.35.40.913
5.4 M TELESCOPIC LANCE
Reference 8.35.40.915



4-HOLE NOZZLE
Reference 8.34.46.801

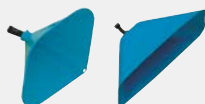

CONICAL HOOD
Reference 8.34.40.870
RECTANGULAR HOOD
Reference 8.34.40.871



6 M HOSE
Reference 8.30.45.805



DOUBLE ADJUSTABLE NOZZLE
Reference 8.34.46.802



QUADRUPLE BOOM
Reference 8.34.60.870



ANTI-DRIFT NOZZLE (INDUCED AIR) 80°
Reference 8.34.46.814
ANTI-DRIFT NOZZLE (INDUCED AIR) 120°
Reference 8.34.46.804



LOW-VOLUME WEED-KILLERS ELBOW
Reference 8.34.60.935



1 M FIBREGLASS LANCE TUBE WITH COMPLETE ELBOW
Reference 8.34.60.873
1.5 M FIBREGLASS LANCE TUBE WITH COMPLETE ELBOW
Reference 8.34.60.874



EXTENSION 0.5M
Reference 8.35.40.870



FLEXIBLE DOUBLE NOZZLE
Reference 8.35.40.871



PRESSURE REGULATOR (EVOLUTION - AGRO GREEN TYPE)
Reference 8.35.47.870



NOZZLE SET
Reference 8.34.46.870



TELESCOPIC EXTENSION
Reference 8.35.40.876

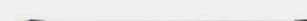

1 M ALUMINIUM LANCE TUBE WITH COMPLETE ELBOW
Reference 8.34.60.871
1.5 M ALUMINIUM LANCE TUBE WITH COMPLETE ELBOW
Reference 8.34.60.872



EXTENDIBLE DOUBLE NOZZLE
Reference 8.35.40.872

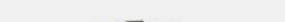

NORMAL WEED-KILLERS ELBOW
Reference 8.34.60.934

SPARE PARTS

Extend the service life of your sprayer easily replacing parts

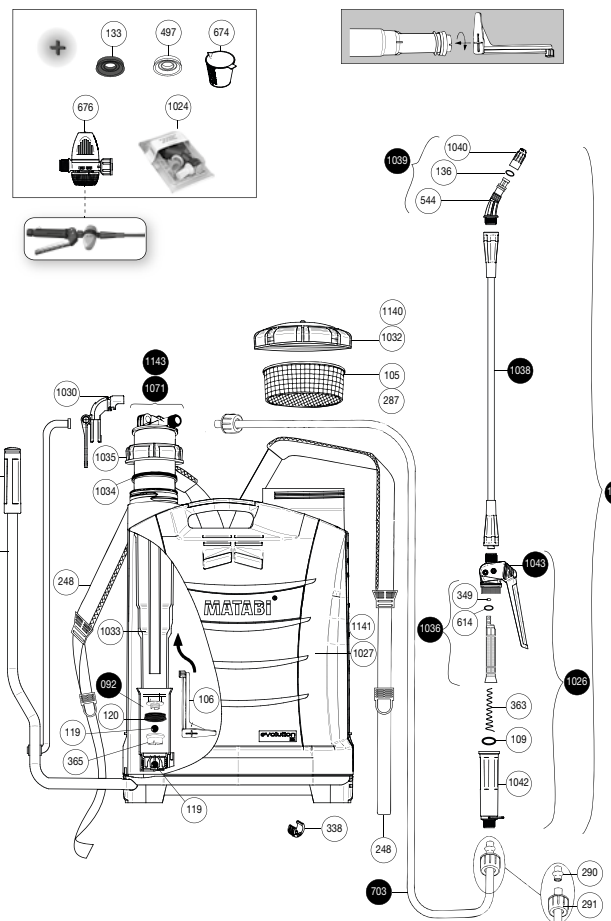

N.	COD.	Q	SPARE PARTS NAME
92	8.39.41.603	1	CYLINDER WITH BALL
105	8.39.18.303	1	FILTER 16 L. TANK
106	8.39.47.306	1	AGITATOR
109	2.23.15.916	1	ROUND GASKET AN-16
119	2.20.08.902	2	STAINLESS STEEL BALL Ø 12
120	8.39.11.305	1	VITON SEAL
133	8.39.09.306	1	RUBBER SEAL
136	2.23.15.905	1	ROUND GASKET AN-5
248	8.39.41.364	2	STRAP
287	8.39.06.303	1	FILTER TANK
290	8.38.08.308	2	HOSE BUSHING
291	8.42.02.332	2	NUT
338	8.39.43.327	1	BASE BUSHING
349	2.23.16.903	1	ROUND GASKET AN-3
363	8.39.41.342	1	FILTER SPRING
365	8.39.41.303	1	SEALING VALVE
497	8.39.41.305	2	OPAQUE SYNTHETIC SEAL
544	8.28.40.322	1	SPRAYER
614	2.23.16.908	1	ROUND GASKET AN-8
674	8.39.41.350	1	100 ML DOSER
676	8.34.47.900	1	PRESSURE REGULATOR
703	8.39.18.805	1	COMPLETE HOSE
1024	8.34.46.815	1	NOZZLES SET
1026	8.49.41.801	1	COMPLETE HANDLE
1027	8.49.41.850	1	16 L. TANK
1028	8.49.41.307	1	GRIP
1029	8.49.41.802	1	COMPLETE LEVER
1030	8.49.41.811	1	LANCE HOOK
1032	8.49.41.602	1	TANK COVER AND VALVE 16 L.
1033	8.49.41.302	1	PRESSURE CHAMBER
1034	8.49.41.410	1	LOCKING WASHER
1035	8.49.41.304	1	GUIDE LID
1036	8.49.41.812	1	FILTER WITH GASKET
1037	8.49.41.823	1	COMPLETE LANCE
1038	8.49.41.627	1	TUBE WITH NUTS
1039	8.49.41.808	1	ELBOW WITH NOZZLE
1040	8.49.41.315	1	NOZZLE Ø 1,5
1042	8.49.41.367	1	GRIP
1043	8.49.41.604	1	HANDLE BODY
1071	8.49.48.814	1	COMPLETE CHAMBER
1140	8.49.49.602	1	TANK COVER AND VALVE
1141	8.49.49.850	1	TANK
1142	8.49.49.304	1	GUIDE LID
1143	8.49.49.814	1	COMPLETE CHAMBER
	8.49.49.200	1	INSTRUCTION SHEET EVOLUTION 12
	8.49.49.201	1	PACKAGING EVOLUTION 12
	8.49.41.200	1	INSTRUCTION SHEET EVOLUTION 16
	8.49.41.201	1	PACKAGING EVOLUTION 16