

INSTRUCTION MANUAL

BilgMon488

15 ppm Bilge Alarm

1 TABLE OF CONTENTS

1	Table of Contents	2
2	Table of validity	4
3	Introduction.....	5
4	Construction	5
5	Operation	5
6	Caution	5
7	Specification	6
7.1	General	6
7.2	Specific 115/230 V AC model	7
7.3	Specific 24 V AC/DC model.....	7
8	Installation.....	8
8.1	Mechanical	8
8.2	Tube arrangement.....	9
8.2.1	Alternative 1	9
8.2.2	Alternative 2	9
8.3	Electrical	10
8.3.1	General installation	10
8.3.2	Fresh water flushing valve installation.....	11
8.3.3	115/230 VAC.....	12
8.3.4	24V AC/DC	12
9	Calibration check.....	13
9.1	Schedule	13
9.2	Calibration certificate expiry date.....	13
9.3	Calibration check requirements	13
9.4	Sensor unit replacement	13
10	Operating Instructions.....	14
10.1	Startup sequence.....	14
10.2	Main menu and indication LEDs.....	14
10.2.1	Main menu	14
10.2.2	LEDs and indications.....	15
10.3	Menu system	16
10.4	Contrast adjustment.....	17
10.5	Simulation.....	17
10.6	Force automatic stopping device activation	19

10.7	Acknowledge alarm	19
10.8	Information menu	20
10.8.1	Master info	20
10.8.2	Sensor info.....	20
10.9	Log	21
10.9.1	Log menu	21
10.9.2	Step log.....	21
10.10	Cleaning & test	22
10.10.1	Clean cell (zero calibration)	22
10.10.2	Check 40NTU cal (calibration check)	22
10.10.3	Test outputs.....	23
10.11	Settings	23
10.11.1	Valve settings (automatic stopping device)	23
10.11.2	Alarm settings (bridge alarm).....	23
10.11.3	Autoflush feature (automatic freshwater cleaning).....	24
10.11.4	Set clock.....	24
10.11.5	Curro mode (Current output mode).....	25
10.11.6	Curro 20mA cal. (Calibration of current output)	25
11	Automatic stopping device test.....	26
11.1	While separator is active.	26
11.2	While separator is not active.	26
12	Response test	26
12.1	Step 1.....	26
12.2	Step 2.....	26
12.3	Alternative	26
13	Calibration check	26
14	Log entries	27
15	Maintenance	28
16	Real Time Clock (RTC).....	29
16.1	Local time	29
16.2	Battery replacement	29
16.3	RTC malfunction	29
16.3.1	Set UTC time	30
17	Log data download via USB	31
17.1	Running the software	31
17.2	Installing the VCP driver	31

17.3	Download procedure.....	31
18	Spare parts list.....	34
19	Troubleshooting	36

2 TABLE OF VALIDITY

The following table describes the software and hardware versions on which this document was based.

<i>Doc version</i>	<i>Master SW ver.</i>	<i>Master PCB ver.</i>	<i>Sensor SW ver.</i>	<i>Sensor PCB ver.</i>
vAA, vAB	C3	Bilgbase_I.1/ Bilgaslv_D.1/ Bilgasco_A Bilgemastex K.1	B5	Bilgemon J.1

3 INTRODUCTION

The BilgMon488 bilge alarm has been designed specifically for use in conjunction with 15 ppm oil-water separator units. BilgMon488 performance meets the requirements of the International Maritime Organisation specifications for 15 ppm bilge alarms contained in resolution MEPC. 107(49).

BilgMon488 is equipped with 2 adjustable alarms that are triggered when the oil-content of the processed sample exceeds the set limit (1 – 15 ppm, works-adjusted to 15ppm). Alarm outputs consist of relays and indicator LEDs. Additionally a 0(4) – 20 mA current output signal (corresponding to 0 – 30 ppm) is available to enable remote surveillance and recording of oil contents.

Downloading the operating log of BilgMon488 can be done through a USB-interface. This requires driver software and cables that can be supplied on demand.

4 CONSTRUCTION

BilgMon488 consists of two main parts, the MASTER unit (housing with LCD, buttons and LEDs) and the SENSOR unit (housing with pipe fittings).

The MASTER unit contains all the electronics used for control and data storage of the bilge alarm. Mounted in the lid of the MASTER housing is the main memory containing the bilgealarm log.

The SENSOR unit contains electronics for measuring the sample stream. The SENSOR unit also holds the measurement calibration data. Communication with the MASTER unit is done wireless hence the SENSOR unit is hermetically sealed and shall not be opened.

5 OPERATION

Optical sensors monitors the amount of light scattered and absorbed by the oil droplets in the sample stream. Sensor signals are processed by a microprocessor to produce a corresponding oil content (ppm) output. The output is communicated to the MASTER unit where it is processed. The MASTER unit takes action, such as alarm activation, logging etc., depending on the oil content and the separator signal.

Settings that affect the behaviour of the bilge alarm are described in detail in section *10 Operating Instructions*.

Zero point calibration can be re-adjusted on site whereas full sensor calibration according to IMO-requirements is performed by manufacturer.

6 CAUTION

Do NOT remove the internal battery for more than a couple of hours (see 16.2 Battery replacement)

Do NOT open the SENSOR unit as this will invalidate the calibration.

Do NOT open the MASTER unit when it is energized. Hazardous voltages are present inside.

7 SPECIFICATION

7.1 GENERAL

Measurement:

Oil range:	0 – 30 ppm
Resolution:	0.1 ppm
Accuracy:	According to IMO MEPC.107(49)
Response time:	< 3 sec

Alarms:

Alarm 1 (valve control) delay:	0-10 sec user adjustable
Alarm 2 (annunciation) delay:	0-600 sec user adjustable
Alarm points 1 and 2:	1-15 ppm user adjustable
Alarm hysteresis:	0.5 ppm (below alarm point)

Data storage and retrieval:

Calibration storage:	Stored in sensor housing.
IMO required data:	Stored in BilgMon488 main housing (sensor housing may be replaced with data remaining on board).
IMO required data retrieval:	Via LCD display, USB.

User interface:

LCD display:	2x16 alphanumeric display
Control:	4 button keypad

Environment:

Ambient temperature range:	According to IMO MEPC.107(49), (0-55°C)
Enclosure ingress protection rating:	IP65

Installation:

Sample line inlet operating range:	Recommended: 1-2 bar (200 – 300 l/h) Maximum: 3 bar
------------------------------------	--

7.2 SPECIFIC 115/230 V AC MODEL

Input/Output:

Current output:	0 – 20 mA or 4 – 20 mA for 0 – 30 ppm
Communications:	USB serial communication (separate cable and software)
Alarm outputs:	2 x relays (0.25A)
Clean water solenoid valve output:	1 x relay (0.5A, supply voltage)
Switch input:	1 x switch input for separator status

System and supply:

Supply:	1 A, 115 or 230 V AC, 50 – 60 Hz
Power consumption electronics:	10 VA
Power consumption solenoid:	18 VA

7.3 SPECIFIC 24 V AC/DC MODEL

Input/Output:

Current output:	0 – 20 mA or 4 – 20 mA for 0 – 30 ppm
Communications:	USB serial communication (separate cable and software)
Alarm outputs:	2 x relays (1A)
Clean water solenoid valve output:	1 x relay (1A, supply voltage)
Switch input:	1 x switch input for separator status

System and supply:

Supply:	1.5 A, 24 V AC (50 – 60 Hz) or 24 V DC
Power consumption electronics:	10 VA
Power consumption solenoid:	18 VA

8 INSTALLATION

NOTE: If drain valve is fitted. It should always be closed while separator is running.

8.1 MECHANICAL

Legend

Item	Qty	Name	type	dimension	Material
d1	4	M6x10	Mounting screws.		Steel
d2	4	M20 cable glands		Opening ϕ 7-12mm	Plastic

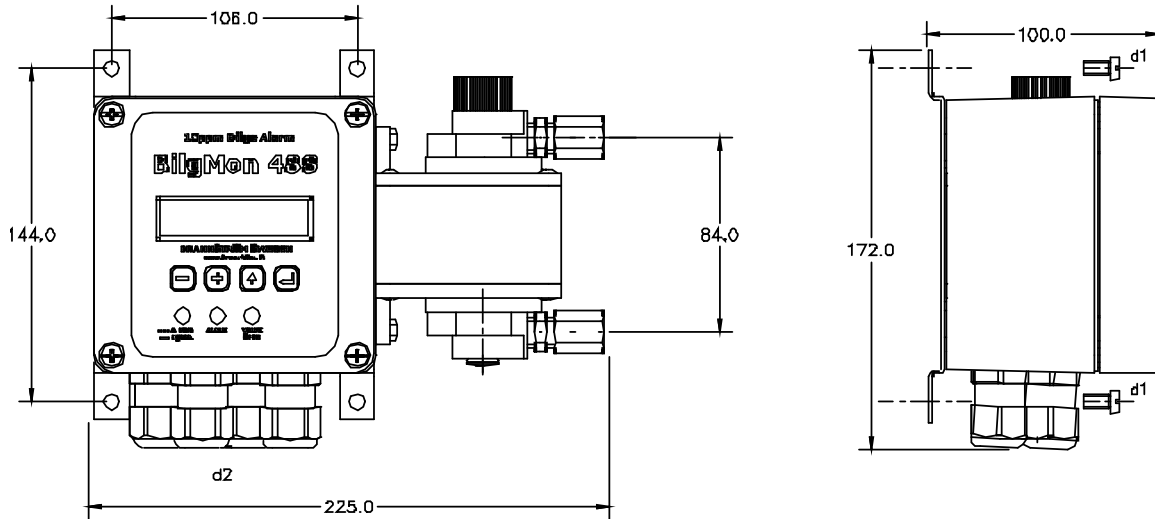

Illustration 1: Mechanical installation

8.2 TUBE ARRANGEMENT

8.2.1 Alternative 1

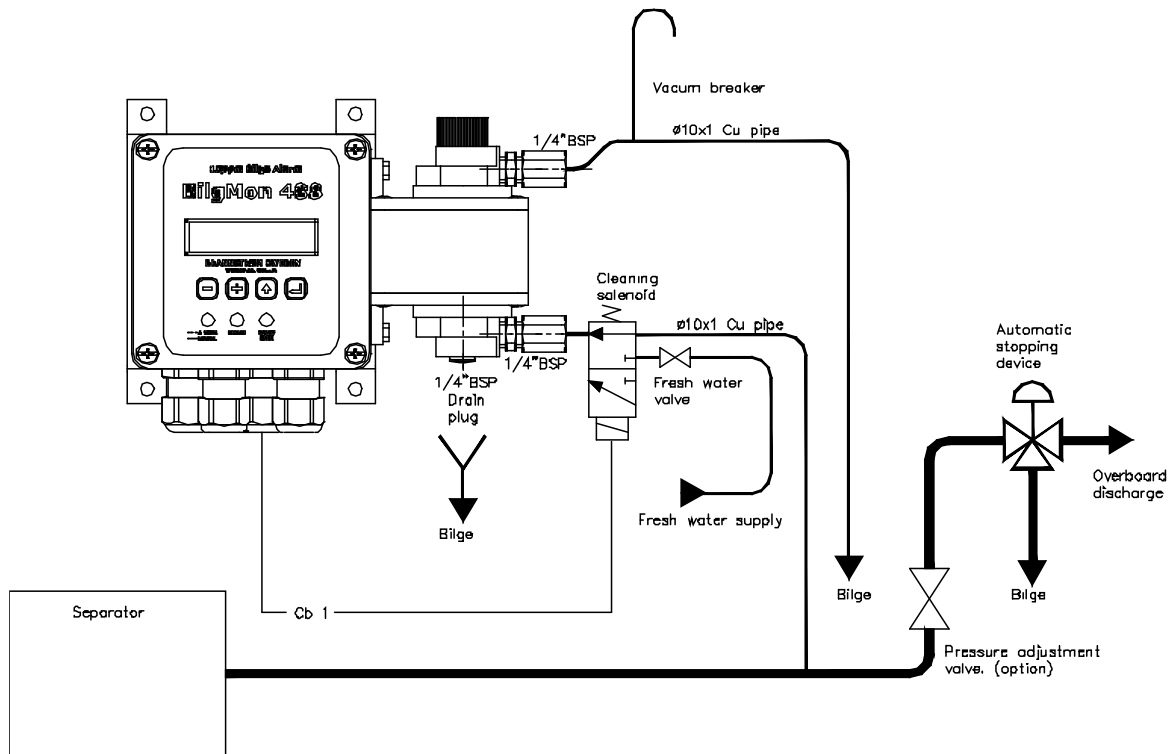

Illustration 2: Tube arrangement alt. 1

8.2.2 Alternative 2

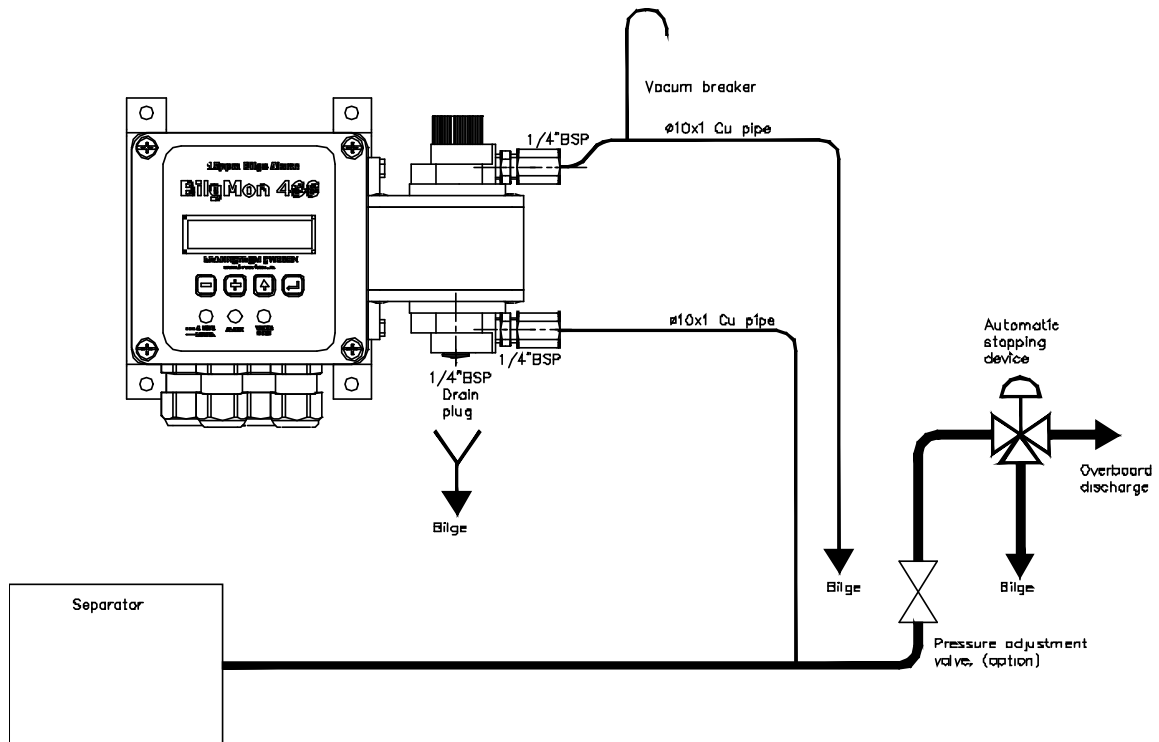

Illustration 3: Tube arrangement alt. 2.

8.3 ELECTRICAL

8.3.1 General installation

Bilgmon488 is manufactured in two base models, **115/230 VAC** and **24 V AC/DC**. The main difference between these two models is the base PCB of the MASTER unit.

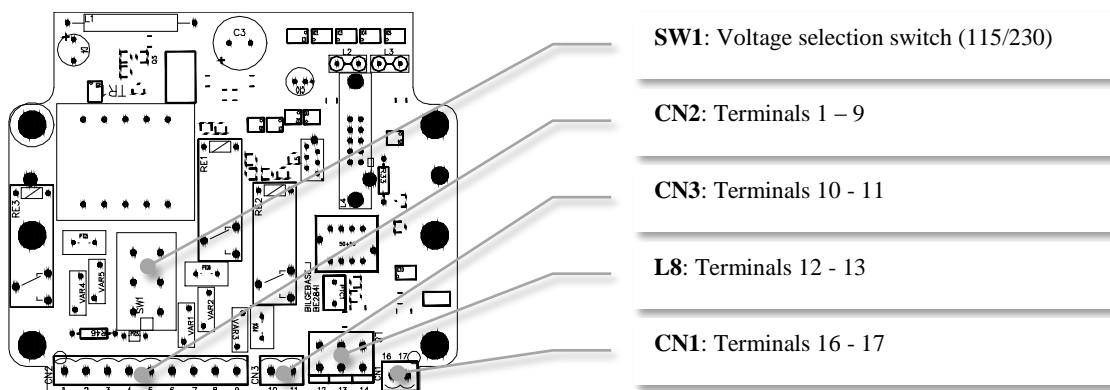

Illustration 4: Base PCB of **115/230 VAC** MASTER unit.

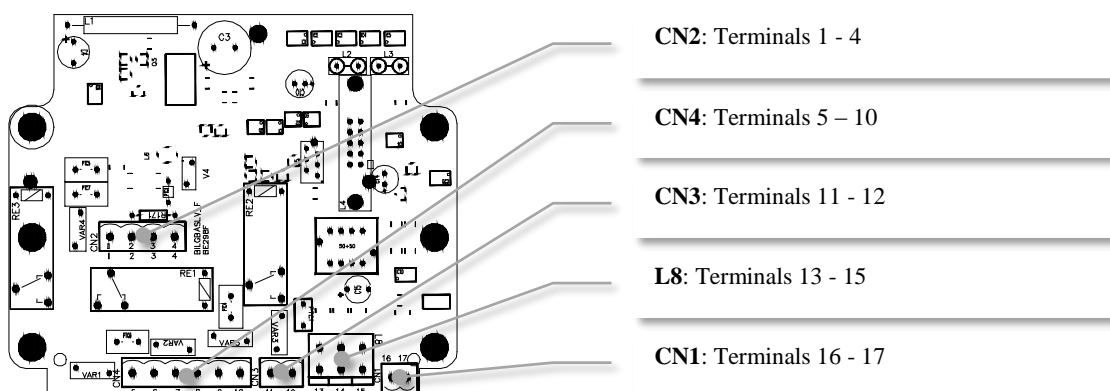

Illustration 5: Base PCB of **24 V AC/DC** MASTER unit.

When installing the **115/230 VAC model** be sure to put the voltage selection switch (**SW1**, Illustration 4) in the correct position (marked 115 resp. 230).

Terminals 12-14 (**L8**, Illustration 4) resp. 13-15 (**L8**, Illustration 5) are coupled and can be used for routing of external protective earth connections.

See sections 8.3.3 and 8.3.4 for detailed information of electrical connections.

8.3.2 Fresh water flushing valve installation

This section is valid for systems using a cleaning solenoid according to Illustration 2: Tube arrangement alt. 1 or similar installation.

115/230 VAC model: There are two coils delivered with the BilgMon 488, one to be used with 115 VAC (marked 96 V) and one to be used with 230 VAC (marked 205 V). Be sure to install the proper one for the chosen voltage.

24 V AC/DC model: Only one coil delivered with this model (marked 24 V).

NOTE: Both models are equipped with a cable and rectifier (in connection plug for solenoid). The rectifier is necessary for all AC installations.

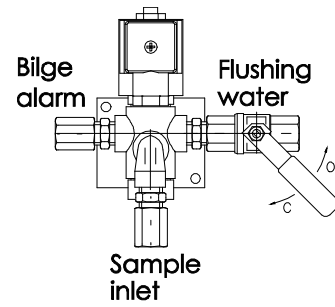

9 CALIBRATION CHECK

9.1 SCHEDULE

Two items needs to be addressed when setting up the maintenance schedule for the BilgMon488:

- Expiry date of the factory issued calibration certificate.
- Occasionally a calibration check is required within the validity period of the factory issued calibration certificate.

The following two subchapters explain how to resolve these two items.

9.2 CALIBRATION CERTIFICATE EXPIRY DATE

If the factory issued calibration certificate expires, the SENSOR unit must be replaced.

The SENSOR of BilgMon488 is designed to be easily replaced by the crew, see *9.4 Sensor unit replacement*. Replacement does not require any adjustments of the MASTER unit setup.

Each new SENSOR is accompanied with a new factory issued calibration certificate.

9.3 CALIBRATION CHECK REQUIREMENTS

On occasion ships may be required to perform a “calibration check” on their units. This might be required to take place at shorter intervals than the validity period of the factory issued calibration certificate.

Calibration check can be achieved in the following ways:

- Checking calibration with a “Calibration Check Kit”.
(Requires ordering a kit or consult a service agent)
- If the calibration check fails (calibration values are not within limits), a new SENSOR must be installed.

9.4 SENSOR UNIT REPLACEMENT

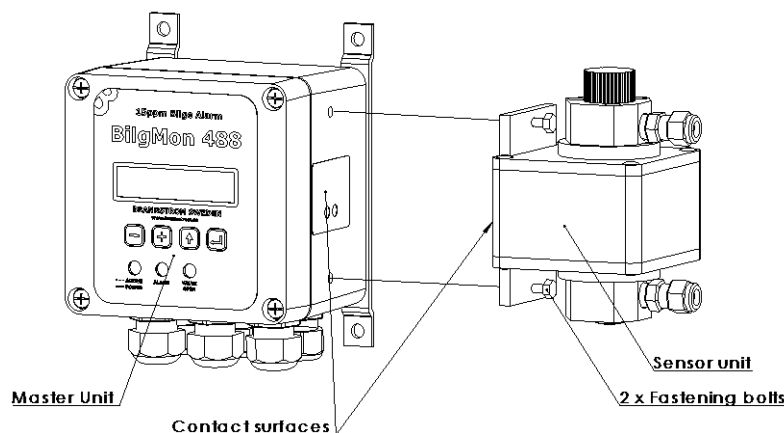

Removing Sensor Unit:

1. Loosen fastening bolts.
2. Gently pull Sensor Unit away from Master Unit.

Mounting Sensor Unit:

1. Clean contact surfaces using water and mild detergent.
2. Hold together Sensor Unit and Master Unit.
3. Tighten fastening bolts.

Master Unit preparations:



No preparations necessary. Sensor Unit contains all calibration data. System updates automatically.

Illustration 8: Sensor unit replacement procedure.

10 OPERATING INSTRUCTIONS

10.1 STARTUP SEQUENCE

When BilgMon488 is powered up the LCD display will show an initialization sequence.

<p>Sequence:</p> <ol style="list-style-type: none"> 1. Internal time reference (Real Time Clock, RTC) is checked. 2. Information about unit setup is shown. <p>Explanation of example shown in 2.:</p> <p>BilgMon 488 - Product name. 00A9 - Software version of master unit. 1dec - PPM value display precision. CO - Current Output facility enabled. 15max - Maximum PPM level for alarm and automatic stopping device settings.</p>	<p>1.</p>  <p>2.</p> 
---	---

10.2 MAIN MENU AND INDICATION LEDs

10.2.1 Main menu

After the initialization sequence is done the unit is ready for operation and the main menu will be shown:

<p>The main menu shows <i>date</i> and <i>time</i> followed by <i>PPM measurement</i> and <i>fresh water flushing valve selection</i>.</p>	
--	--

Date and *time* is set at factory to UTC time (Coordinated Universal Time) and is displayed on the format:

YYMMDD hh:mm:ss (YY – year, MM – month, DD – day, hh – hour, mm – minutes, ss – seconds)

PPM measurement shows the latest measurement of oil content in parts per million as reported by the sensor unit.

Fresh water flushing valve selection shows the current selection (control output) to the optional fresh water flushing valve:







SPL – sample from separator selected

WTR – fresh water flushing input selected

<p>If the internal clock battery backup voltage is too low the display will display a warning (see right) every 2 seconds.</p> <p>See 0 Real Time Clock (RTC) for further information.</p>	
---	--

10.2.2 LEDs and indications

The LED lamps on the front panel indicate the status of the equipment. The straight/dashed lines indicate if the lamps are lit continuously/flashing.

(green)  ACTIVE POWER	 	Bilgmon488 is in ACTIVE mode (separator is running). BilgMon488 is in POWER mode (menu subsystem is active).
(red)  ALARM	(no signal) 	No alarm present. Alarm.
(yellow)  VALVE OPEN	(no signal) 	Automatic stopping device activated (back to bilge tank). Automatic stopping device NOT activated (overboard valve open).

The LED lamps on the front panel indicate the status of the equipment. The straight/dashed lines indicate if the lamps are lit continuously/flashing.

10.3 MENU SYSTEM

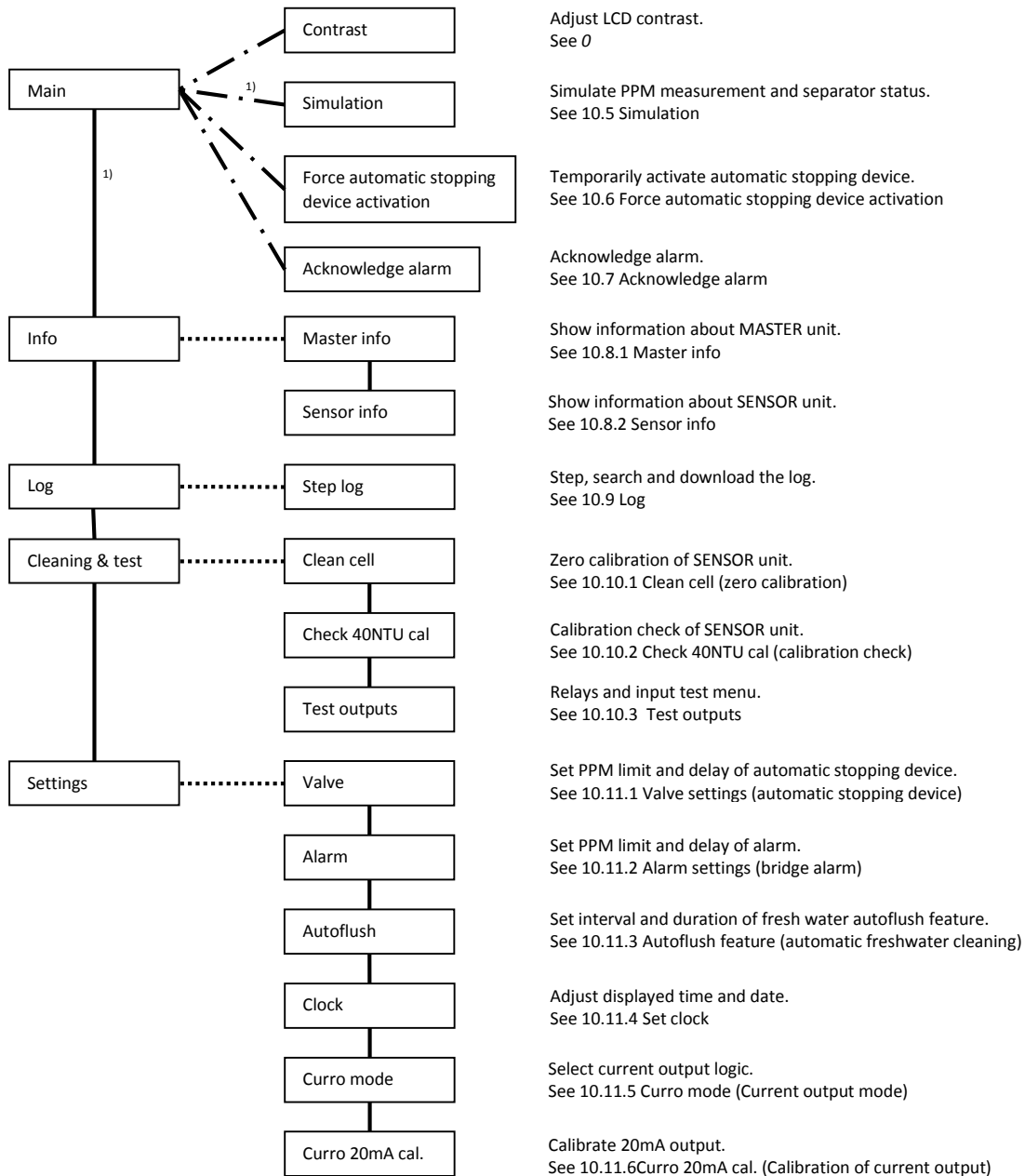

1) Transition only possible when BilgMon488 is in POWER mode (see 10.2).

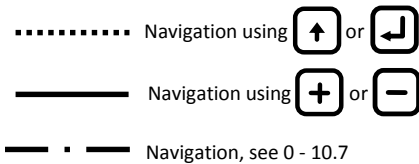





Illustration 9: Menu layout

10.4 CONTRAST ADJUSTMENT

While in *main menu* press and hold .

With  held press  /  to increment/decrement contrast setting by 10%.





10.5 SIMULATION

The simulation menu lets user simulate the PPM input from the sensor unit as well as the separator status input state to verify that the installation of the unit is correct and that it responds as expected to different oil content measurements.

Simulated events will be stored in the log starting with a SIM_ON event and ended with a SIM_OFF event.

Enter *simulation menu*¹:

From *main menu* press and hold . The LCD will now show something similar to the picture on the right.
Keep holding  to stay in the *simulation menu*.



Leave *simulation menu*:

Release .

Toggle the simulated separator status input:

While still holding , press  to toggle between separator on/off (SEP_ON/SEP_OFF shown in LCD).







Increment/decrement simulated PPM value:

While holding , press  /  to increment/decrement the simulated PPM value in steps of 1.0.



¹ To enter the simulation menu the BilgMon488 needs to be in POWER mode. POWER mode is when the unit is powered but separator is not running (separator status input is open, see 8.3 *Electrical*).

Example of simulation with explanations:

<p>1) Start in <i>main menu</i> with separator off (separator status input open).</p>	<div style="border: 2px solid black; padding: 5px; text-align: center;"> <p>140613 09:50:24 PPM>30.0 SPL</p> </div> <p>ALARM LED – OFF VALVE LED – OFF (no discharge)</p>
<p>2) Hold  (do not release until step #7 in this example).</p> <p><i>Automatic stopping device (ASD) is now active² and the alarm is not active since the separator is not running.</i></p>	<div style="border: 2px solid black; padding: 5px; text-align: center;"> <p>Simulation SPL PPM>30.0 SEP_OFF</p> </div> <p>ALARM LED – OFF VALVE LED – OFF (no discharge)</p>
<p>3) Press  to simulate that the separator starts running (toggle to SEP_ON).</p> <p><i>ASD and alarm is now active since the PPM value is above 15 PPM and the separator is running.</i></p>	<div style="border: 2px solid black; padding: 5px; text-align: center;"> <p>Simulation SPL PPM>30.0 SEP_ON</p> </div> <p>ALARM LED – ON VALVE LED – OFF (no discharge)</p>
<p>4) Press  repeatedly until PPM value is below 15.0 ppm (14.0 or lower value shown).</p> <p><i>ASD and alarm is now NOT active since the PPM value is below 15.0 ppm and the separator is running.</i></p>	<div style="border: 2px solid black; padding: 5px; text-align: center;"> <p>Simulation SPL PPM=14.0 SEP_ON</p> </div> <p>ALARM LED – OFF VALVE LED – ON (discharge)</p>
<p>5) Press  repeatedly until PPM value is above 15.0 PPM (16.0 or higher value shown).</p> <p><i>ASD and alarm is now active since the separator is running and the PPM value is above 15.0 ppm.</i></p>	<div style="border: 2px solid black; padding: 5px; text-align: center;"> <p>Simulation SPL PPM=16.0 SEP_ON</p> </div> <p>ALARM LED – ON VALVE LED – OFF (no discharge)</p>
<p>6) Press  to simulate that the separator stops running (toggle to SEP_OFF).</p> <p><i>ASD is now active and the alarm is not active since the separator is not running.</i></p>	<div style="border: 2px solid black; padding: 5px; text-align: center;"> <p>Simulation SPL PPM=16.0 SEP_OFF</p> </div> <p>ALARM LED – ON VALVE LED – OFF (no discharge)</p>
<p>7) Release  to return to <i>main menu</i> and end simulation.</p>	<div style="border: 2px solid black; padding: 5px; text-align: center;"> <p>140613 09:50:24 PPM>30.0 SPL</p> </div> <p>ALARM LED – OFF VALVE LED – OFF (no discharge)</p>

² The VALVE LED and the automatic stopping device output has reversed logic. Hence when VALVE LED is lit the automatic stopping device is NOT active (overboard valve in discharge position) and vice versa.



10.6 FORCE AUTOMATIC STOPPING DEVICE ACTIVATION

When the separator is running and the PPM value is below 15.0 ppm the automatic stopping device can be temporarily activated by pressing and holding  for approx. 2 sec.

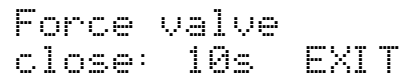
After 10 seconds or on a press of  BilgMon488 returns to normal operation.



10.7 ACKNOWLEDGE ALARM

If separator is running (separator status input is closed, BilgMon488 in ACTIVE mode) and the PPM value goes above 15.0 ppm the unit will generate an alarm (alarm output terminal and LED). The alarm can be acknowledged³ by pressing ,  or . This means that the alarm output terminal will be put in no alarm position but the alarm LED on the front will still be lit.

³ Automatic stopping device output cannot be acknowledged (only alarm output).

10.8 INFORMATION MENU

The information submenus will display⁴ information about the MASTER and the SENSOR unit of BilgMon488 according to examples below:

10.8.1 Master info

<i>Cycle 0:</i> Menu name.	Master info
<i>Cycle 1:</i> Serial number.	Master ID: 000A-4567
<i>Cycle 2:</i> Software version.	Master SW ver: 00C3
<i>Cycle 3:</i> Master unit lid power supply voltage. Should be approx. 5V.	Master voltage: 5V supply=5.3V
<i>Cycle 4:</i> RTC backup battery voltage. Should be approx. 3V. If lower than 2.5V, replace battery ().	Master voltage: RTC battery=3.0V
<i>Cycle 5:</i> Internal time reference (RTC). Should be UTC time and date (approximately).	Master UTC: 140427 18:23:34

10.8.2 Sensor info



<i>Cycle 0:</i> Menu name.	Sensor info
<i>Cycle 1:</i> Serial number.	Sensor ID: 000B-4325
<i>Cycle 2:</i> Software version.	Sensor SW ver: 00B6
<i>Cycle 3:</i> Factory calibration date.	Sensor date: 140112 13:23:10
<i>Cycle 4:</i> Calibration check date.	Cal. checked: 140427 10:43:12
<i>Cycle 5:</i> SENSOR internal measurements (temperature, moisture, voltage etc.).	T: 25.3 Dry: 60 U3: 3.20 U03: .312

⁴ Information is continuously cycling (cycle 0, cycle 1, ... , cycle n, cycle 0, ...).



















10.9 Log

The log menu enables the user to search and step the IMO-regulated log of the BilgMon488 as well as download parts of or the entire log to file using the “BilgMon488 log download kit” (purchased separately).

10.9.1 Log menu

<p>The log menu shows the serial number stored in the log memory (normally same as the serial number of the master unit) and the number of log items currently stored in log.</p> <p>Press  to enter the <i>step log</i> submenu.</p>	
--	--

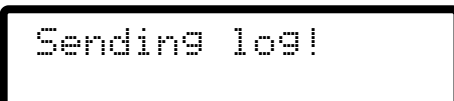
10.9.2 Step log





<p>First row of <i>step log menu</i> shows type of event and second row shows date and time of occurrence.</p> <p>Stepping: Navigate the log by pressing  resp.  to step forwards resp. backwards in the log.</p>	
<p>Searching: Press  and a small cursor will appear in under the first entry in the date field. Press  again to move the cursor cyclically through the date/time fields. Use  and  to increase/decrease the digit marked by the cursor. Finish by holding  for approx. 3 seconds. The display will now show the event that is closest in time to the date/time you entered.</p>	
<p>Sending log via USB (download kit required): When leaving the <i>step log</i> menu () user is asked to send log.</p> <p>If user answers no () the unit returns to <i>log menu</i>.</p> <p>If user answers yes () a follow up question is asked of how many items from the current and forward (in time) is to be sent 100, 500 or all. Select with  /  and finalize by holding  for approx. 3 seconds.</p> <p>LCD will show “sending log” while sending the log followed by “sent xxxx” when download is complete.</p>	   

10.10 CLEANING & TEST

10.10.1 Clean cell (zero calibration)

The *clean cell menu* provides the facility to zero calibrate the BilgMon488. It is also a useful tool for checking on dirt, layering and scratches on the sample tube inside the SENSOR unit.

Values shown range from 0% (clean, same values as factory calibration) to 100% (dirty) where 50% or below is required to perform zero calibration.





<p>Press  to start zero calibration process.</p>	
<p>Toggle fresh water flushing valve to position WTR by pressing . Make shure the fresh water supply line is closed to prevent the liquid poured in to the SENSOR is not flushed out “backwards”. Unscrew the top cap of the SENSOR, clean thoroughly with mild detergent and soft , rinse and then pour in some clean airfree water. When/if zero value goes below 50%, ZERO is shown. Press  enter to send zero calibration command to SENSOR unit.</p>	

If zero value does not go below 50% see 19 Troubleshooting.

10.10.2 Check 40NTU cal (calibration check)

The *check 40NTU cal* lets the user perform a calibration check⁵ of the equipment. The calibration check makes shure that the units sensors are still in good condition and that the measurements of the oily water is still accurate.

Values range from 0% to 100% where 80% or above is considered acceptable (using calibration check kit mixture).







<p>Press  to start calibration check process.</p>	
<p>Toggle fresh water flushing valve to position WTR by pressing . Make shure the fresh water supply line is closed to prevent the liquid poured in to the SENSOR is not flushed out “backwards”. Unscrew the top cap of the SENSOR and fill with the calibration check kit mixture. When/if cal. value goes above 80%, OK is shown. Press  enter to set the calibration check date of the SENSOR unit.</p>	

If cal. value does not go above 80% see 19 Troubleshooting.

⁵ Doing a calibration check requires the “Bilgmon488 calibration check kit” (bought separately).

10.10.3 Test outputs









The *test outputs menu* is used for testing the function of the separator status input as well as the alarm, automatic stopping device and fresh water flushing valve outputs (see 8.3 *Electrical*).

<p>Press  to enter <i>test outputs</i> menu.</p>	
<p>ALM: Press  to toggle the alarm output.⁶ VLV: Press  to toggle the valve (automatic stopping device) output.⁶ WTR: Press  to toggle the fresh water flushing valve output. O/C: In the upper right corner the status of the separator status input is displayed (O = Open, C = Closed).</p>	

10.11 SETTINGS





10.11.1 Valve settings (automatic stopping device)

This menu allows the user to lower the detection level for valve output (automatic stopping device output). This might be useful in cases where lower limits than 15 ppm oil content is requested. There is also an adjustable delay (max 10 seconds) of the valve output. Factory defaults are 15 ppm limit, 0 sec delay.





<p>Press  to display the cursor (under leftmost digit).</p> <p>Press  /  to increase/decrease digit.</p> <p>Press  to move cursor right one digit (cursor moves cyclically from left to right, one step per ).</p> <p>Save setting by holding  until cursor disappears.</p> <p>Abort input at any time by pressing  (cursor disappears, previous values are filled in).</p>	
--	--

10.11.2 Alarm settings (bridge alarm)

This menu lets the user set the parameters for the alarm output.

<p>Press  to display the cursor (under leftmost digit).</p> <p>Press  /  to increase/decrease digit.</p>	
---	--









⁶ Alarm and Valve output can only be activated 10 seconds at a time and will always generate an active alarm output. Seconds countdown is shown on LCD.

<p>Press  to move cursor right one digit (cursor moves cyclically from left to right, one step per .</p> <p>Save setting by holding  until cursor disappears.</p> <p>Abort input at any time by pressing  (cursor disappears, previous values are filled in).</p>	
---	--

10.11.3 Autoflush feature (automatic freshwater cleaning)

If system is fitted with a freshwater flushing valve it is possible to let the unit clean itself at set intervals with fresh water if the separator is not running. This menu lets the user set the interval at which the cleaning should be performed (in hours) and the duration of the cleaning/flushing (in seconds). If a duration of 0 seconds is chosen the feature is disabled (off).

Note: The autoflush feature is disabled when the separator is running (separator status input is closed).

<p>Press  to display the cursor (under leftmost digit).</p> <p>Press  /  to increase/decrease digit.</p> <p>Press  to move cursor right one digit (cursor moves cyclically from left to right, one step per .</p> <p>Save setting by holding  until cursor disappears.</p> <p>Abort input at any time by pressing  (cursor disappears, previous values are filled in).</p>	
---	--

10.11.4 Set clock









The BilgMon488 has an internal timekeeping mechanism with a battery backup. This mechanism is referred to as RTC (Real Time Clock). The RTC is set at production to UTC time (Coordinated Universal Time).

The *set clock* menu lets the user adjust the local time of the unit (as shown in the *main menu*). The local time is handled internally as an offset to the RTC time.

The local time setting affects the time and date shown in *main menu* as well as the *log menu* according to the example below:

1. *Set clock* = local time:
Main menu will display local time and date.
Log items will be shown in local time and date.
2. *Set clock* = UTC time:
Main menu will display UTC time and date.
Log items will be shown in UTC time and date.





Note: Before inspecting the log, make sure the clock is set to the wished time frame (local time or UTC).

<p>Press  to display the cursor (under leftmost digit).</p> <p>Press / to increase/decrease digit.</p> <p>Press  to move cursor right one digit (cursor moves cyclically from left to right, one step per ).</p> <p>Save setting by holding  until cursor disappears.</p> <p>Abort input at any time by pressing  (cursor disappears, previous values are filled in).</p>	
--	--

10.11.5 Curro mode (Current output mode)

The current output of BilgMon488 can be altered between two modes, 0-20 mA and 4-20 mA. These intervals correspond to 0-30 ppm oil content as displayed in the *main menu*.



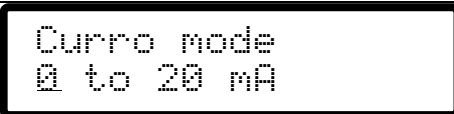



The current output terminal can be used for external printing/logging of the momentary oil content measurement.

<p>Press  to display the cursor.</p> <p>Press / to alter mode.</p> <p>Save setting by holding  until cursor disappears.</p> <p>Abort input at any time by pressing  (cursor disappears, previous values are filled in).</p>	
--	---

10.11.6 Curro 20mA cal. (Calibration of current output)

If current output corresponds badly to the displayed oil content the current output can be calibrated in this manu (one point calibration).

When entering this menu the BilgMon488 will try to output 20 mA (corresponding to 30 ppm). Measure the output with ampere meter. If reading is not correct adjust the output according to below instruction.

<p>Press  to display the cursor.</p> <p>Press / to increase/decrease the current output signal (adjust to 20 mA output).</p> <p>Save setting by holding  until cursor disappears.</p> <p>Abort input at any time by pressing  (cursor disappears, previous values are filled in).</p>	
--	--

11 AUTOMATIC STOPPING DEVICE TEST

11.1 WHILE SEPARATOR IS ACTIVE.

If the separator is active and the automatic stopping device is not activated (overboard valve open) it is possible to force the activation of the stopping device for a short period of time (10 s) by holding  in the *main menu*. This allows testing that the automatic is correctly connected.

11.2 WHILE SEPARATOR IS NOT ACTIVE.

To check that the automatic stopping device is correctly connected see *12.2 Step 2*.

12 RESPONSE TEST

12.1 STEP 1

To check that the sensor responds to objects in the measuring path unscrew the cleaning cap (top of SENSOR housing) and insert a long plastic rod or something similar into the measuring path. **Do not** use anything that might scratch or in other ways damage the glass tube inside the SENSOR housing (as for example screwdrivers). If the sensor is working properly the display should read “PPM>30.0” (main menu). Note that the air-detection feature of the SENSOR requires the glass tube to be filled with water during this test for it to work.

12.2 STEP 2

Testing alarms and valves are done in simulation mode (see *10.5 Simulation*) or in the *test outputs* submenu of the *cleaning & test* menu (see *10.10.3 Test outputs*) since this doesn't require opening the MASTER housing.

12.3 ALTERNATIVE

To make step 1 of the response test affect alarms and valves the apparatus needs to be active. Bilgmon488 is activated (flashing green led) when in main menu and the separator input signal is active. Activation can be done by shorting the “separator status” input (see *8.3 Electrical*). This method is **not recommended** since there is an obvious risk of forgetting the strap and that it requires opening the MASTER unit. It will also generate a false recording of OWS operation (SEP_ON/SEP_OFF) in the log.

13 CALIBRATION CHECK

Doing a *calibration check* requires the “Bilgmon488 calibration check kit” (bought separately). This kit also contain detailed information on procedures and mixtures used in the calibration check procedure.

See sections *10.10.1 Clean cell (zero calibration)* and *10.10.2 Check 40NTU cal (calibration check)*.

Note: Complete calibration can only be performed by factory. Calibration check will perform a zero calibration and a check of the units calibration values compared to those set at production.

14 LOG ENTRIES

<i>Type</i>	<i>Example</i>	<i>Explanation</i>
POWER ON	Log: POWER ON 060102 11:36:32	Power was turned on at given date and time (yymmdd hh:mm:ss).
POWER OFF	Log: POWER OFF 060102 14:06:10	Power was turned off.
SEP ON	Log: SEP ON 060102 12:10:12	Separator signal input turned from not activated to activated.
SEP OFF	Log: SEP OFF 060102 12:23:34	Separator signal input turned from activated to not activated.
PPM ABOVE	Log: PPM > 15 060102 12:15:13	Measured oil content went from below set valve ppm level to above (in example valve setting is 15 ppm). Automatic stopping device activated.
PPM BELOW	Log: PPM < 15 060102 12:17:42	Measured oil content went from above set valve ppm level to below (in example valve setting is 15 ppm). Automatic stopping device deactivated.
PPM AVG	Log: PPM AVG 04 051021 09:47:29	PPM average when below set valve ppm limit since latest SEP ON signal or latest PPM BELOW event.
PPM SET	Log: PPM SET 05 060102 13:10:07	Valve ppm level setting was changed to indicated value (in example to 5 ppm).
SIM ON	Log: SIMLON 060102 12:09:50	Simulation was turned on.
SIM OFF	Log: SIMLOFF 060102 12:24:19	Simulation was turned off.
TIME OFFSET	Log: TIME OFFSET +0:59:46	Time offset was adjusted (in settings menu). Offset to BilgMon builtin realtime clock in hours, minutes and seconds is shown.
RTC SET	Log: RTC SET 051021 09:47:29	BilgMon builtin realtime clock was set (logged once at factory).
NEW SENSOR	Log: NEW SENSOR 051021 12:47:29	A new sensor was attached.

15 MAINTENANCE

The BilgMon488 can be set to autoflush (see *10.11.3 Autoflush feature (automatic freshwater cleaning)*). This means that the sensor tube is flushed with clean water at durations and intervals as set in the settings menu. Autoflush is only active when in main menu and BilgeMon488 is not active.

Cleaning the measurement unit should be done using a soft bottle-brush and mild detergent. Note that there is a glass tube inside the SENSOR unit so don't use anything that might scratch or damage the glass (i.e. metal objects). If the glass tube is layered with rust or similar try using low concentrated acid (for example hydrochloric acid). Rinse well and make sure you protect your eyes, skin and airways if using acidic substances.

Check the expiry date of the factory issued calibration certificate (9.2 Calibration certificate expiry date).

16 REAL TIME CLOCK (RTC)

The timekeeping mechanism in Bilgmon488 is referred to as the Real Time Clock (RTC). The RTC is essentially a crystal oscillator backed up by a battery and a capacitor. The RTC keeps track of the UTC time and date and is essential for keeping the log of Bilgemon488 correct.

16.1 LOCAL TIME

In the settings of each Bilgmon488 there is a possibility to adjust the displayed time. This affects how time and date are displayed on the display (main menu, log items etc.). This setting is stored and used as an offset to the internal time (RTC-time).

The internal UTC time and date can be checked in one of the cycles of the *master info* menu (see *10.8.1 Master info*).

16.2 BATTERY REPLACEMENT

The RTC backup battery is coupled in parallel with a backup capacitor. This means that the Bilgemon488 can keep its RTC running for a couple of hours without the battery present.

The RTC battery (type CR1225) is located on the backside of the master unit lid (see illustration).

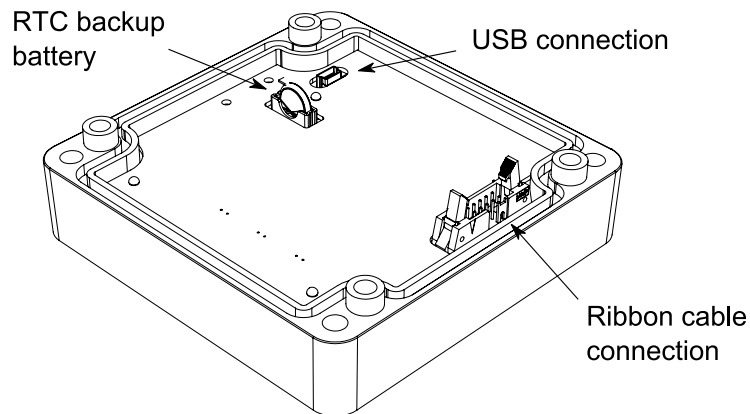

Illustration 10: Master unit lid backside

Battery replacement procedure:

1. Disconnect the power supply.
2. Open the lid of the master unit (loosen 4 screws in the corners of the lid).
3. Push on the metal clip (holding the battery) and pull the battery out of the socket.
4. Replace with new battery of type CR1225 as soon as possible (within a couple of hours).

16.3 RTC MALFUNCTION

In the event of the RTC stopping the following message will appear:

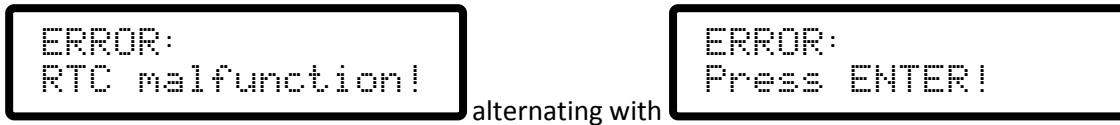

When pressing  the user enters the *RTC recovery menu* (see Illustration 11: RTC recovery menu layout).

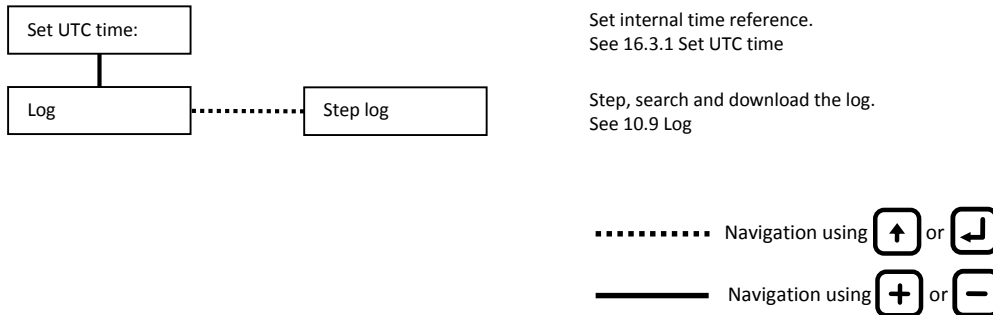

Illustration 11: RTC recovery menu layout

16.3.1 Set UTC time

If the battery voltage is too low (< 2.5 V) the following warning will be shown:



Follow the battery replacement procedure (16.2 Battery replacement).

When the battery is replaced and the voltage has increased to above 2.5V (might take a couple of minutes if the backup capacitor is exhausted) the following menu will appear:

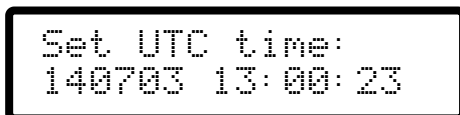

Enter correct UTC time and date using same method as described in 10.11.4 Set clock.

After setting UTC the following will be displayed,



Followed by,





Followed by,



Verify that display is showing the correct UTC date and time.

Press  if UTC is correct or  to go back to *Set UTC time* menu.

NOTE: After pressing  the RTC recovery menu is left and user is returned to main menu. **Make sure that the UTC date and time is correct before pressing .**

17 LOG DATA DOWNLOAD VIA USB

Apart from inspecting the log via the LCD (see 10.9 Log) there is a possibility to download the log via a USB-connection to a personal computer running Windows operating system.

NOTE: This procedure requires the “Bilgmon488 log data download kit” consisting of a CD with software and a USB cable.

17.1 RUNNING THE SOFTWARE

Insert the CD and the BM488 log receiver program should start automatically after a short period of time. If not, doubleclick “BM488_log_receiver.exe” in the “dist”-library of the CD to start the log receiver.

17.2 INSTALLING THE VCP DRIVER

The first time you connect your bilge alarm to your PC using the supplied USB-cable you will be asked for a driver for the newfound hardware. Simply point to the CD and the operating system will find the driver for you. To install the driver manually, doubleclick the “CDM#.##.##.exe” in the root directory of the CD.

The VCP (Virtual Com Port) – driver has to be installed for the connected bilge alarm to show up in the log receiver software. Note that the VCP-driver installation is only necessary once per PC.

For the latest version of the VCP driver please visit:
<http://www.ftdichip.com/Drivers/VCP.htm>

17.3 DOWNLOAD PROCEDURE

The following steps will guide you through the process of downloading data from the log of your bilge alarm. Instructions prerequisite that the CD is inserted in your computer, that the VCP-driver is installed and that the “BM488_log_receiver.exe”-program is started.

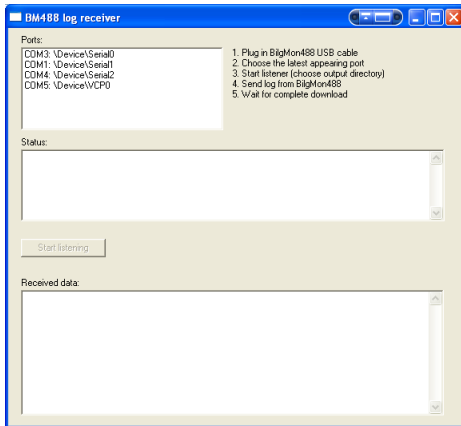

Illustration 12: Initial screen, waiting for connection

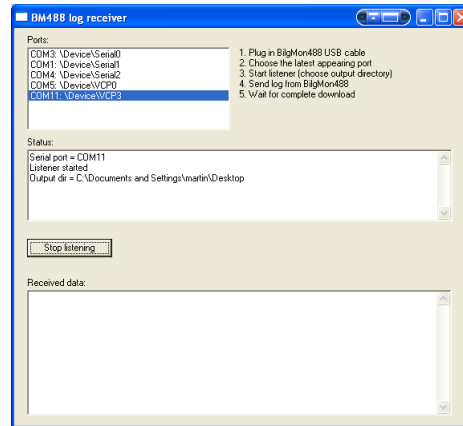

Illustration 13: Connected (VCP3) and listening

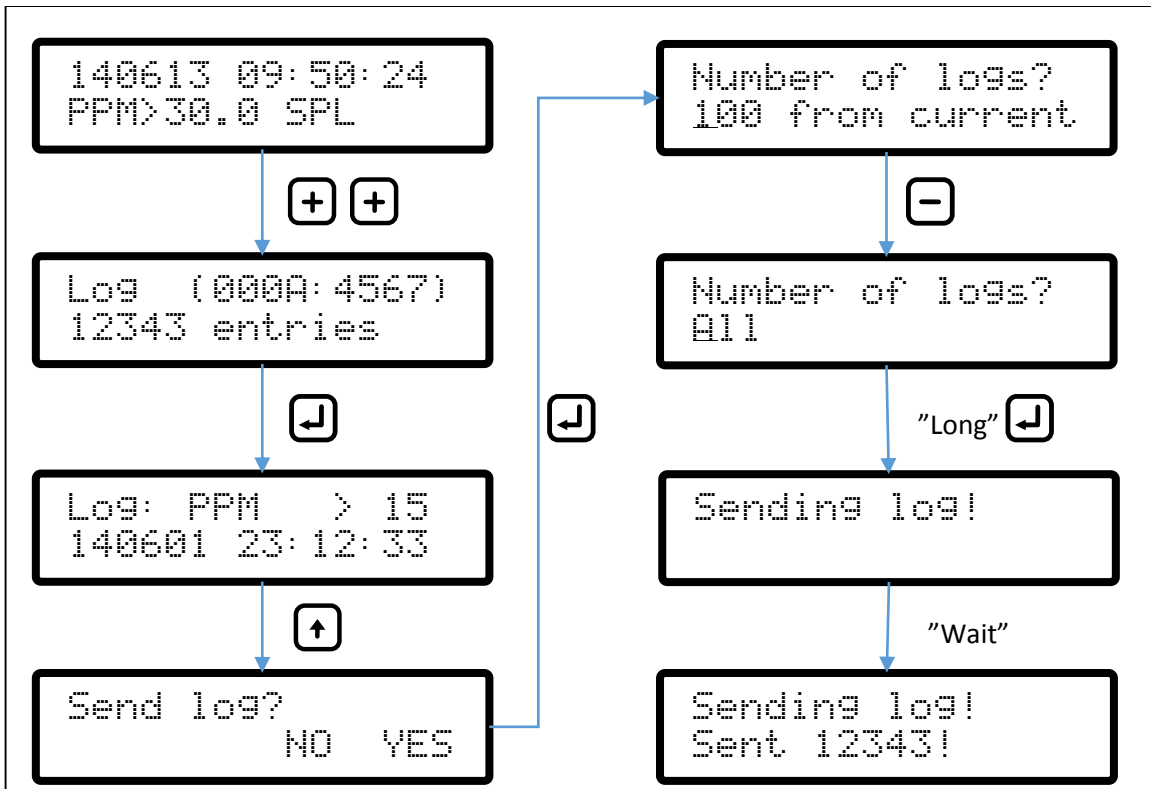

Illustration 14: Send log data from Bilgmon488

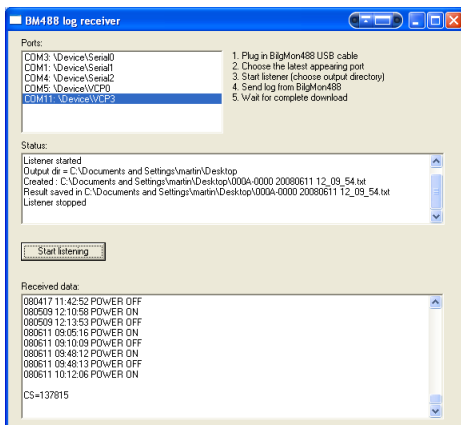

Illustration 15: Log data download completed

Steps:

1. Initial screen is shown (see Illustration 12: Initial screen, waiting for connection). The program is now waiting for a USB-connection.
2. Connect the BilgMon488 to your PC using the USB-cable. Note that the the bilge alarm does not need to be connected to a power supply since it gets power from the USB-cable. The connected bilge alarm will show up last in the "Ports:" list.
3. Choose the latest appearing port from the list.
4. Click the "Start listening"-button. A dialogue will appear where you can choose an output folder for the downloaded result.
5. The software is now listening for data from BilgMon488 (see Illustration 13: Connected (VCP3) and listening).
6. On your BilgMon488 navigate to the log-menu and step in to the log. When exiting the log you will be asked if you want to send the log. Answer yes and choose the amount of data to download (see Illustration 14: Send log data from Bilgmon488). While the data is sent it will show up in the "Received data" section of the log receiver.
7. When the download is finished the filename and position of the result can be found in the "Status:" list (see Illustration 15: Log data download completed).
8. Close the application.

18 SPARE PARTS LIST

<i>Pos¹</i>	<i>Description</i>	<i>Order nr.</i>
1	Sensor unit	BM201001A-1
2	Master unit	BM201001A-2
3	Fresh water flushing valve assembly	BM201001A-3
4	Calibration check kit, comprising: <ul style="list-style-type: none">• Cleaning brush• Syringe• Bottle 500 ml with lid• Bottle 50 ml, calibration check liquid.• Instructions• Cleaning cap	BM201001A-4

¹ See Illustration 16: General assembly/Spare parts.

NOTE: When ordering service or spares please quote the serial numbers of the MASTER and SENSOR units.

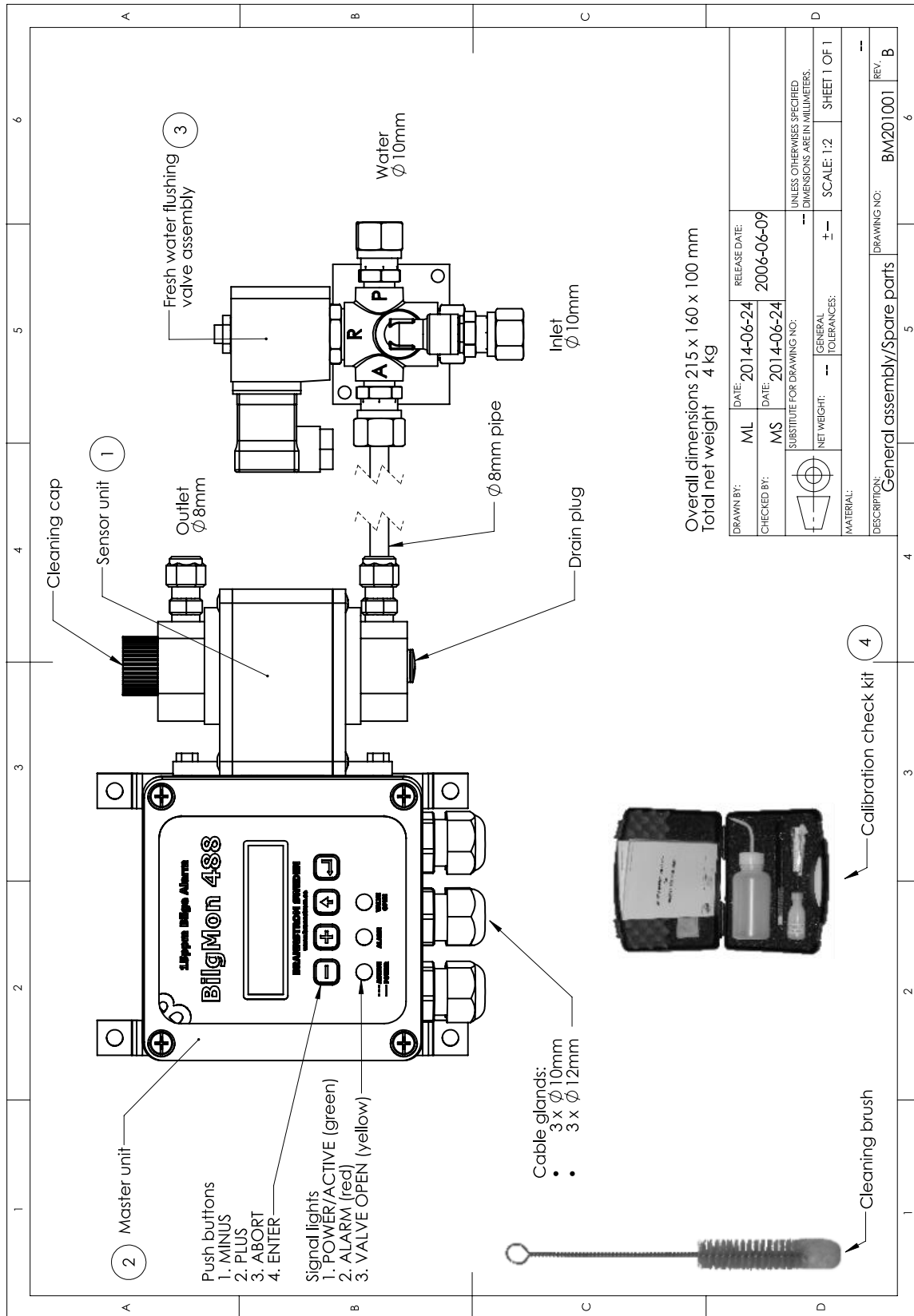

THE INFORMATION CONTAINED IN THIS DRAWING IS THE SOLE PROPERTY OF BRANNSTROM SWEDEN AB. ANY REPRODUCTION IN PART OR AS A WHOLE WITHOUT THE WRITTEN PERMISSION OF BRANNSTROM SWEDEN AB IS PROHIBITED.

Illustration 16: General assembly/Spare parts

19 TROUBLESHOOTING

Symptom	Possible reason(s)	Servicing
BilgMon488 is switched on but LCD remains blank.	Power supply is erroneous.	Check connections internally, externally and power supply voltages.
	LCD monitor is broken.	Order replacement part.
	Automatic fuses blown.	Disconnect externals that might have caused the short-circuit (f.ex. fresh water flushing valve). Wait until fuses have cooled down power up the unit again.
Oil content measurement (ppm value) remains high.	Dirty sensor tube.	Clean the sensor tube and performe zero calibration (see 10.10.1 Clean cell (zero calibration))
	Air is present in sample.	Correct cause of air presence. Clean the sensor tube and performe zero calibration calibration (see 10.10.1 Clean cell (zero calibration))
	Excessive contaminates present in sample (rust, bacteria etc ...)	Correct cause of contamination. Clean the sensor tube and performe zero calibration calibration (see 10.10.1 Clean cell (zero calibration))
LCD display indication: MEMORY ERROR, MEMORY WRITE ERROR, ERASE ERROR	Memory malfunction.	Order replacement part.
	Memorychip not present.	Order replacement part.
LCD display indication: Lost sensor com!	Dirty or damaged MASTER-SENSOR contact area.	Part MASTER and SENSOR units. Clean contact surface with mild detergent.
LCD display indication: RTC check: FAILED!	Internal time reference stopped/malfunctioning.	Replace backup battery, then enter UTC time and date (see 16.3 RTC malfunction).



Provided by www.bmi-instruments.nl

