

The logo for 'CONNECT IT BOAT' is displayed in white text on a dark blue, rounded rectangular background. The word 'CONNECT' is on the top line, 'IT' is on the second line, and 'BOAT' is on the third line. The letter 'O' in 'BOAT' is replaced by a blue circular icon containing a white boat silhouette and a white wave symbol.

CONNECT
IT BOAT

Connect it Boat

User Manual

A close-up photograph of a thick, light-brown rope coiled around a silver metal cleat on the white edge of a boat. The background is a blurred view of blue water.

www.connect-it-boat.com

Connect it Boat (CiB) Device

We congratulate you on the purchase of your new CiB device. This user manual will help you to install and use the device very fast and without any trouble. Please read the description carefully. Please note that the technical specification and data included in the user guide can be changed without any notice.

The manufacturer assumes no responsibility for errors or omissions in this document. You can obtain up-to-date information from our website www.connect-it-boat.com.



Important Features

- The CiB device is a compact waterproof GPS tracker designed for a wide variety of vessel tracking applications.
- Its built-in GPS receiver has superior sensitivity and fast time to first fix. Its quad band GPRS/GSM subsystem supports 850/900/1800/1900 MHz.
- Smart data acquisition based on time, distance, angle, speed delta, ignition and I/O events allow to have precise online tracker
- Small and easy to mount case

Product Overview



Package Part List

		Details	
CiB device		72.5mm*73mm*27.3mm	
SIM card		Preinstalled in CiB device	
Quickstart guide with username, password			
QR code Android		QR code iOS	
	Android	iOS	
Link and QR code for Connect it Boat Portal: www.connect-it-boat.com			

EC Declaration of Conformity

Technical Construction File Details

(EC Identification No. 0678)

The CiB device is certified with the CE conformity: CE 0678
Compliance of the product with the essential safety requirements is demonstrated through full observation of the following standards:

EN 60950-1:2006 + A1:2010 + A2:2013 + A11:2009 + A12:2011

EN 303 446-1 V1.1.0

EN 301 511 V9.0.2

EN 303 413 V1.1.1

Basic Technical Specifications

	Specification
Operating voltage	6V to 30V DC
Backup battery	1800mAh Li-ion 3,7V
Transmit protocol	TCP/IP, UDP/IP, SMS
Case	Water proof, IP67 certified
Positioning	GPS, GLONASS, GALILEO, BEIDOU, SBAS, QZSS, DPGS, AGPS
Updates	Over-the-air configuration and software updates

Interface Description

There are 10 wires on the CiB device extension cable. The following wires are used: power (red and black wire, 1st battery), ignition input (yellow wire), digital input (white/green wire) to bilge pump and analog input (grey) to an optional 2nd battery. The cables' definition is shown in the following table.

Description of the CiB device user cables

Index	Color	Description	Comment
1	Red	Power	Battery + (6-30V)
2	Black	GND	Battery - (GND)
3	Yellow	DIN1	Ignition input, positive trigger
4	White/ Green	DIN2	Digital input, positive trigger (bilge pump)
5	Grey	AIN1	Analog input, optional 2 nd battery (0-30V)
6	White		not used
7	Violet		not used
8	White/ Orange		not used
9	Green		not used
10	Blue		not used

Electrical Connections

Power supply connection (1st Battery) and optional 2nd Battery connection (voltage measurement):

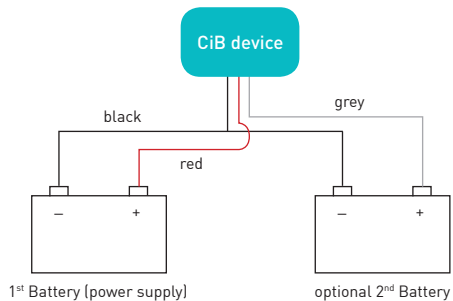

Bilge Pump Connection

Connect White/Green wire to bilge pump positive signal:

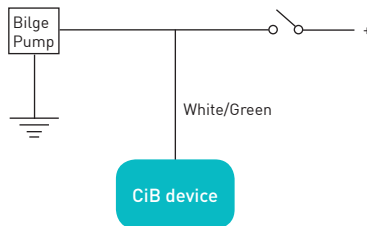

Ignition detection:

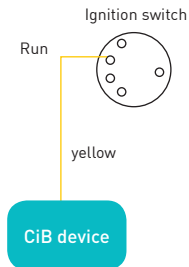

How to Use Your Connect it Boat Solution

The following information specifies how to operate a CiB device safely in order to avoid dangerous situations. Please read these instructions carefully and follow them strictly before operating the device! To avoid mechanical damage, it is advised to transport the CiB device in an impact-proof package. Before usage, the device should be placed in such a way that the LED indicators are visible, as these show the operation status of the device. The device uses an external and internal power source. The allowed range of voltage for the external power source is 6V – 30V DC. In the event of loss of external power source, an internal power source is provided by means of a 1800mAh Li-ion 3,7V battery. The device is connected to the external power source on the vessel using an red (+) and black(-) wires. The manufacturer is not responsible for any radio or TV interference caused by unauthorized modifications to this equipment. Please be aware that this device is intended only for usage inside a boat and should by no means be used for other applications.

Mounting Instructions

The CiB device must be installed by a specialized marine electrician from a recognized electrical company. Connect it Boat cannot be held liable for damages or injuries and any material damage or injury resulting from the use of the CiB application and device caused because of incorrect wiring of electrical installations.

Instructions for the Professional Electrician

- Install the device in a secure area, preferably out of sight (for security reasons).
- Attach the device to a dry and accessible location in the interior of the boat with strong adhesive tape or screws (not supplied).
- Avoid attaching the device to the underside of the wooden deck as the wood may retain moisture thereby compromising the device signal.
- Avoid mounting the device too close to other electrical devices as they may cause interference.
- The device must be mounted horizontally with the device label facing upwards.
- Ensure that the device is mounted in a good reception location (mobile phone network and GPS signal).
- To safeguard the circuit and the device from being damaged, a fuse must be installed to the external power SUPPLY (we recommend using a 1A fuse).

General Instructions

- The device will start automatically when it is powered-up with the external power source.
- A minimum distance of 20cm must be maintained between the device and operator at all times.
- Although the device is waterproof (IP67), it is however advised to avoid prolonged or repeated contact with water.

Safety Instructions

- Please ensure that the power supply of the vessel is disconnected during the mounting or dismounting of the device.
- Please do not attempt to disassemble the device by yourself.
- The device should not be exposed to temperatures above 70 °C. Exposure to direct sunlight must be avoided. High temperatures will damage the device and may result in battery explosion.
- If parts of the device or the whole device are broken or become very hot, do not use the device any more.
- Keep the device out of reach of children or animals at all times.
- Do not use the device on an airplane or near medical equipment.

Environmental Notice

- The product must not be disposed of with regular household waste.

Installing the Connect it Boat Mobile App

1. Download of the App for iOS (App Store) or Android (Google Play Store) via QR-Code or search for Connect it Boat-App
2. Enter your login credentials (username/password) included in the package part list.

Using the Connect it Boat App

After you're successfully logged in with your account, the app should look like this:

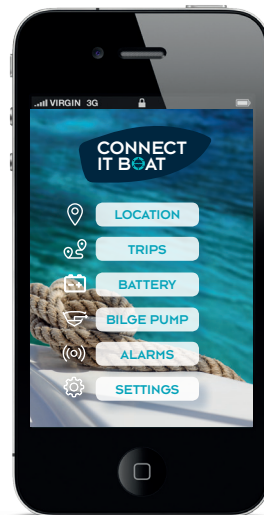

The following functions are available (subject to change):

- Location
- Trips
- Battery
- Bilge pump
- Alarms
- Settings

Accessing the Connect it Boat Web Portal

1. Open link **www.connect-it-boat.com** in your Google Chrome Browser
2. Log in with your credentials (account/password included in your package part list)

Customer Service Supported By

t-matix solutions gmbh
support.cib@t-matix.com

www.connect-it-boat.com