

CANDIS

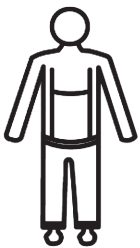

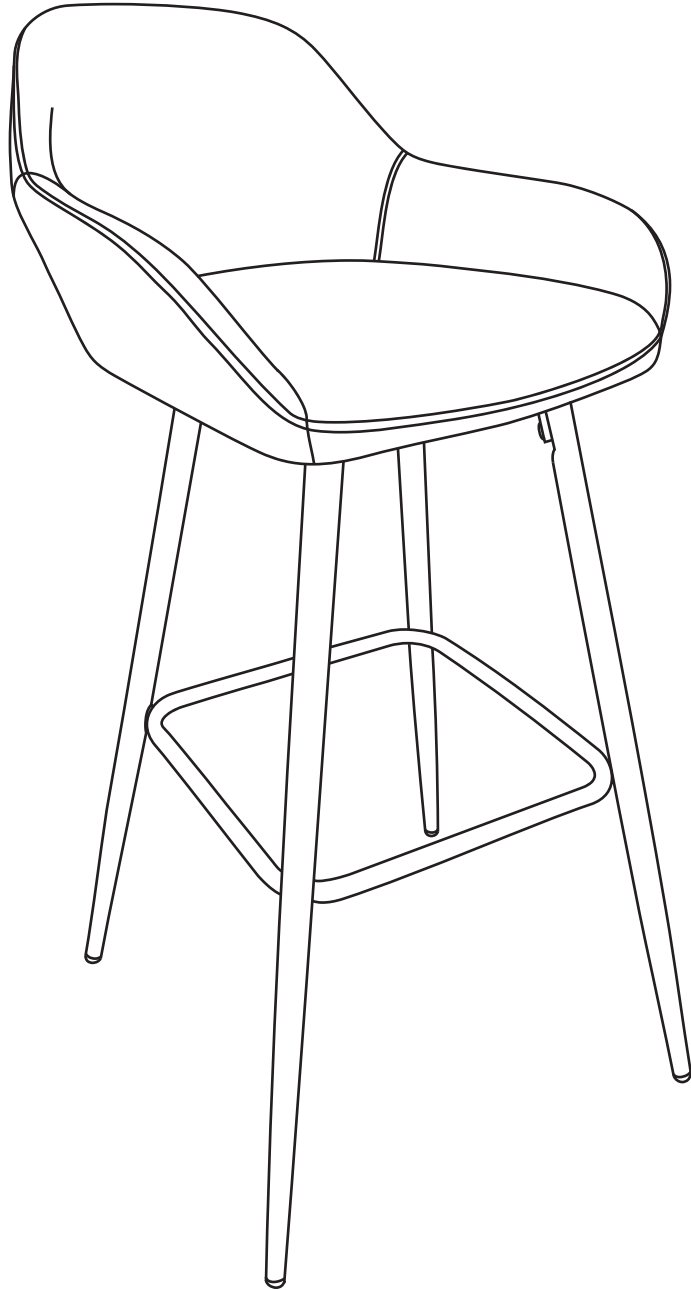

Ax(1)

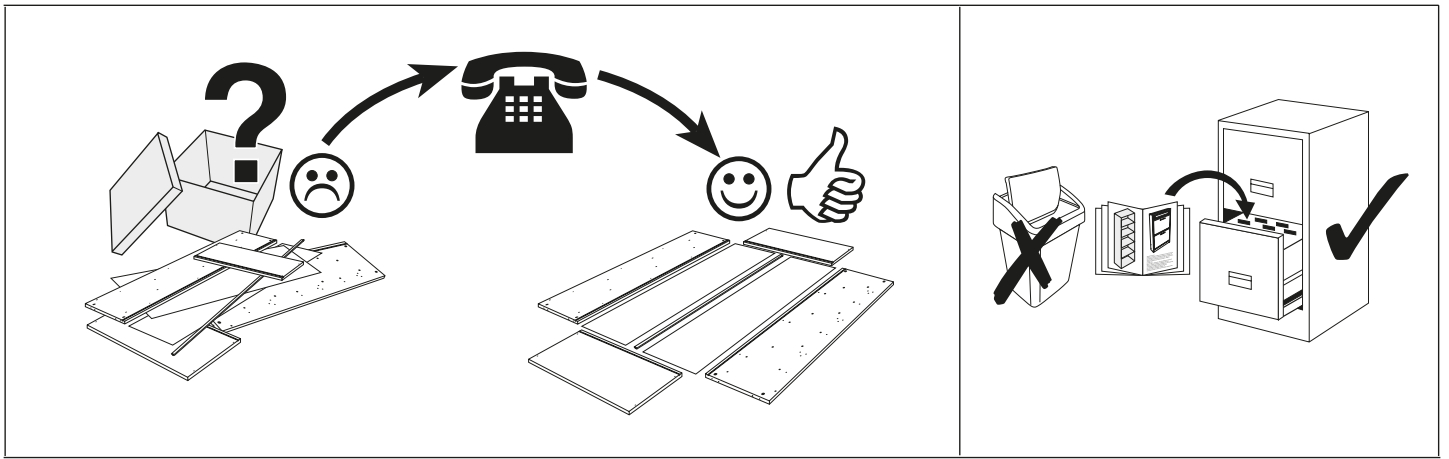
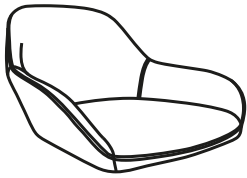

Bx(1)

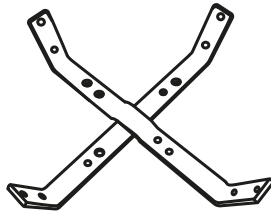

Cx(4)



Dx(1)

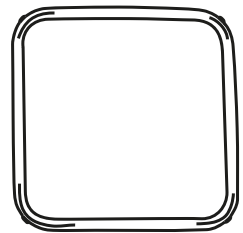

M6x18
Ex16

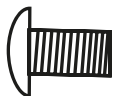

M6x30
Fx4



H



CANDIS

1

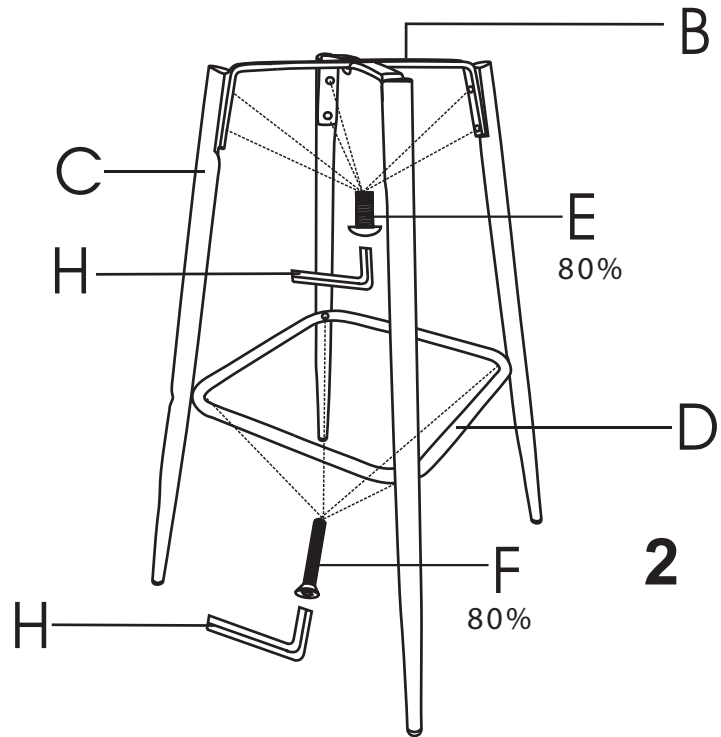

2

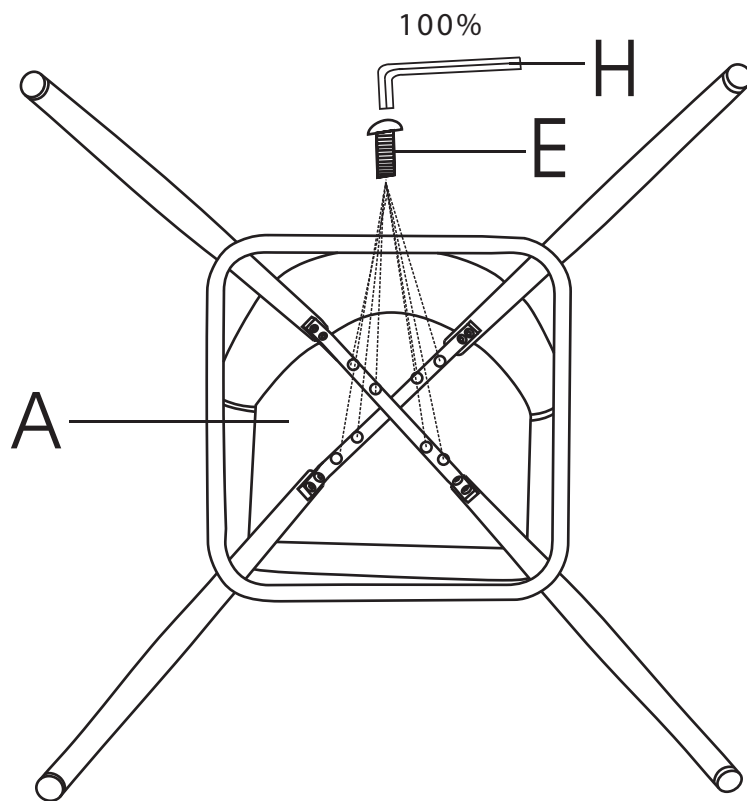

3

