

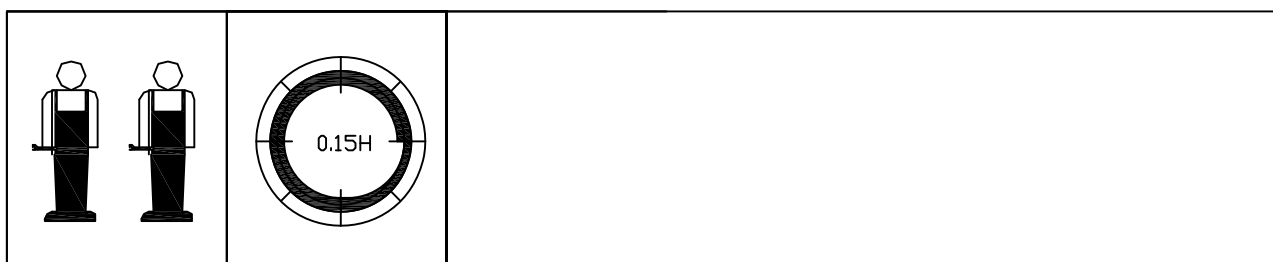

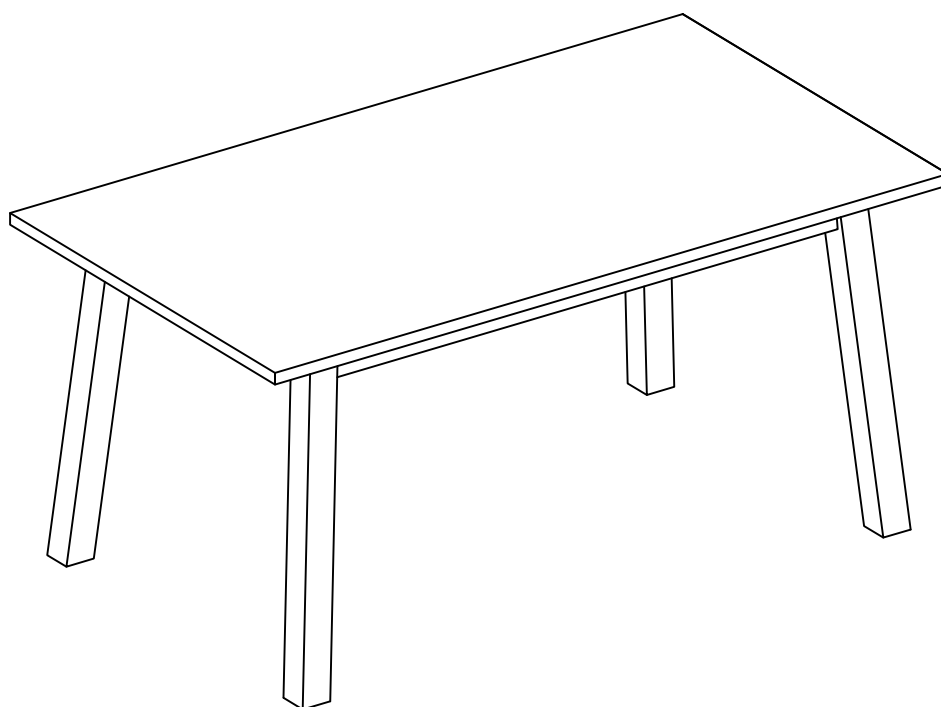

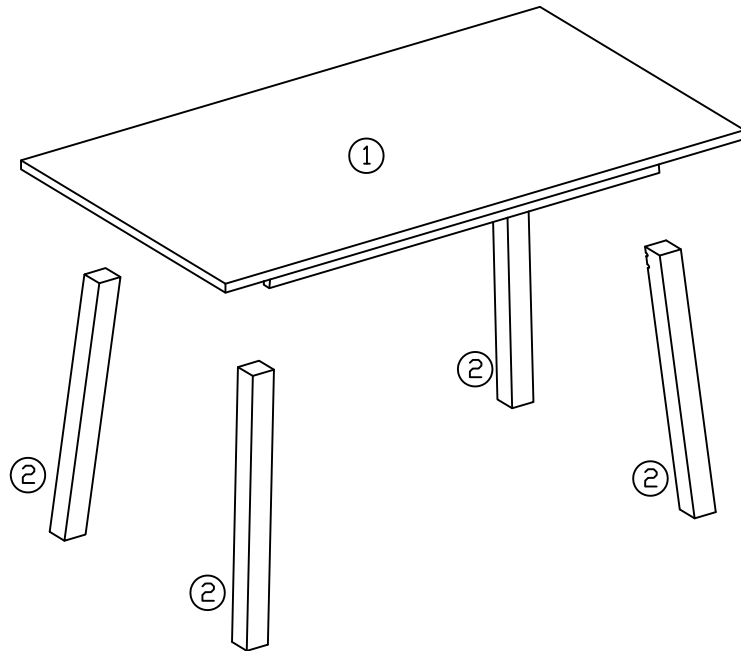

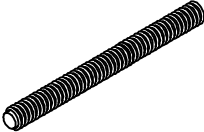

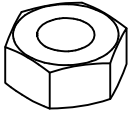

Chara

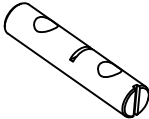
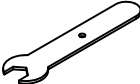
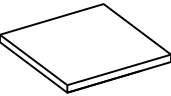

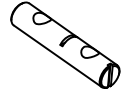

 <p>A x8 M8*90</p>	 <p>B x8 M8</p>	 <p>C x8 M8</p>	 <p>D x8 Ø8/Ø16</p>
 <p>E x4 Ø12*60</p>	 <p>F x1 12mm</p>	 <p>G x4 55*55*3</p>	

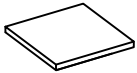
						
A x8	B x8	C x8	D x8	E x4	F x1	G x4

