

SMZ7^{PRO} 3G

USER MANUAL

COM Board : 1.6.0.3 / LCD Board : 2.9.1.3



smartsystem

MADE IN ITALY

Main Index

1	Safety.....	4
2	Packing List.....	5
3	Specs.....	5
4	SmartCAM SM7-PRO-3G Overview.....	6
5	Register the product on SmartSystem Care Platform.....	9
6	Electronic modular Design.....	9
7	Powering the monitor.....	9
7.1	Daisy chain output.....	10
8	Turning on the monitor.....	10
8.1	Understanding Main Status LED.....	10
9	Booting process.....	10
10	Interacting with the Monitor.....	11
10.1	Interaction with Main Knob.....	11
10.2	Interacting via Touch screen.....	11
11	Function buttons.....	12
11.1	Association between Monitor Function and Function Buttons.....	12
12	Navigating the menu.....	13
12.1	Setup.....	13
12.1.1	LEDs Color.....	13
12.1.2	Backlight.....	13
12.1.3	Auto Backlight.....	13
12.1.4	Tally.....	13
12.1.5	Video Alignment.....	14
12.1.6	Menu Setup.....	14
12.1.7	Thermal.....	14
12.1.8	Firmware.....	15
12.2	Color.....	15
12.2.1	LUT Switch.....	15
12.2.2	LUT Import.....	15
12.2.3	Brightness.....	15
12.2.4	Contrast.....	15
12.2.5	Saturation.....	15
12.2.6	Hue.....	15
12.3	Image.....	16
12.3.1	Scan Mode.....	16
12.3.2	Aspect Ratio.....	16
12.3.3	Crop & Zoom.....	16
12.3.4	Anamorphic.....	17
12.3.5	Pixel to Pixel.....	17
12.3.6	Image Flip.....	17
12.3.7	Freeze.....	17
12.4	Marker.....	17

12.4.1	Cinema Guides.....	17
12.4.2	Safe Areas.....	18
12.4.3	Cross Hatch.....	18
12.4.4	Crosshair.....	19
12.5	Assist.....	19
12.5.1	Focus Assist.....	19
12.5.2	Sharpness.....	20
12.5.3	Zebra.....	20
12.5.4	CheckField.....	20
12.5.5	False Color.....	21
12.6	Waves.....	21
12.6.1	Waveform.....	21
12.6.2	VectorScope.....	21
12.6.3	Y Istogram.....	21
12.6.4	RGB Istogram.....	22
13	Zen PRO.....	22
13.1	System.....	22
13.2	Axis.....	22
13.3	Style.....	23
13.4	Resolution.....	23
13.5	Safe Areas.....	23
13.6	Speed.....	23
14	Firmware Upgrade.....	24
15	Maintenance.....	24
16	Disposal.....	24
17	Warranty.....	25



This manual refers to the following firmware revision:

- **COM Board : 1.6.0.3**
- **LCD Board : 2.9.1.3**

In case your monitor has a different version, upgrade it via Burner as reported in Par.13

1 Safety

SmartCAM SM7-PRO-3G has been designed considering all the technical regulations concerning the product.

Please, carefully read the safety instructions and retain for future reference.

- Protect your equipment from heavy dust environments.
- Avoid, if possible, any contact with water or other liquids
- Clean only with a dry cloth or lightly soaked in distilled water.
- Do not use a power supply different from the one provided with the product.
- In case of failure, the SM7-PRO-3G must be repaired only by qualified staff, authorized by SmartSystem Srl.
- Do not remove any part or disassembly the SmartCAM SM7-PRO-3G. There are no reusable parts in the SmartCAM SM7-PRO-3G
- Due to the constant effort of product improving, SmartSystem reserve the right to make changes and improvement to the product described in this manual

WARNING



To prevent fire, explosion or electrical shock, **NEVER USE** the product under heavy rain or partially or totally submerged

TO AVOID ELECTRICAL SHOCK, DO NOT OPEN THE PRODUCT FOR ANY REASON. ALWAYS REFER TO QUALIFIED STAFF AUTHORIZED BY SMARTSYSTEM SRL.



The user has been informed about the importance of reading and understanding the safety instructions contained in this manual.



SM7-PRO-3G is completely fanless and rely on its heatsink

/ heatspreader in order to dissipate the heat generated once all the 3200nits are used. It can get very hot. This behavior is normal. Please be careful.

2 Packing List

- 1x SmartCAM SM7-PRO-3G
- 1x 2Pin Push-Pull DC-DC cable 50cm / 19.7"
- 1x Neoprene soft-shell
- 1x Resin Hard case
- 1x XTDongle for firmware upgrade
- 1x 5gr Silica bag

3 Specs

- High performance ruggedized design Monitor
- 7" 1920x1200 resolution with contrast ratio of 1200:1
- Up to 3200nits of maximum brightness
- Full 3G-SDI compliant (SMPTE 425A / SMPTE 425B) with 1 buffered output
- 2x pole Push-Pull connectors for a quick daisy chain connection
- 1x XTBus Port
- 1x Tally Input
- 1x USB Type A for LUT Upload
- Power Supply Range : 9VDC to 34VDC
- Max power consumption : less than 25W at full brightness
- Working Temperature : -20°C ~ +40°C
- Working Environmental Humidity: 10% ~ 80%
- Weight : 1.25kgs / 2.75lbs



SM7-PRO-3G was tested **extensively** under **natural rain** with a **maximum inclination of the monitor of 45° respect the horizontal axis**. Using it at lower inclination is to be avoided in order to facilitate the water flow outside the monitor using the dedicated paths.

The use of artificial rain where minerals, chlorine amount as well as electrical conductivity is unknown could led to unexpected results. If in doubt, take the necessary precautions.

Never ever block the water outlets on the bottom of the monitor



**IN THE CASE OF MALFUNCTION OF THE SM7-PRO-3G,
CONTACT AN AUTHORIZED SMARTSYSTEM TECHNICIAN.**

DO NOT OPEN YOUR SM7-PRO-3G IN ORDER TO MAKE QUICK AND MAKESHIFT REPAIR.

4 SmartCAM SM7-PRO-3G Overview

Reference	Description
A	Function Buttons F1 -F2 – F2 -F3 – F4 – F5 – F6 – F7 – F8
B	Function LEDs (RGB)
C	Main Knob + Push Button
D	Adaptive Backlight Sensor
E	Power Button
F	Main Status LED (RGB)
G	Lateral attachment 1/4-20 UNC
H	Heat Spreader
I	3G-SDI Video Input
J	3G-SDI Video Output
K	USB Type A Data input
L	Tally Input (Compatible with LEMO® 0B.303)
M	XT Port (power and data)
N	Daisy chained Output + Protection (Compatible with LEMO® 0B.302 – ARRI® Standard)
O	Main input + Protection (Compatible with LEMO® 0B.302 – ARRI® Standard)
P	Water management outlets
Q	Additional Accessories
R	Fault indicator (Over / Under voltage)
S	1/4-20UNC Top Connection

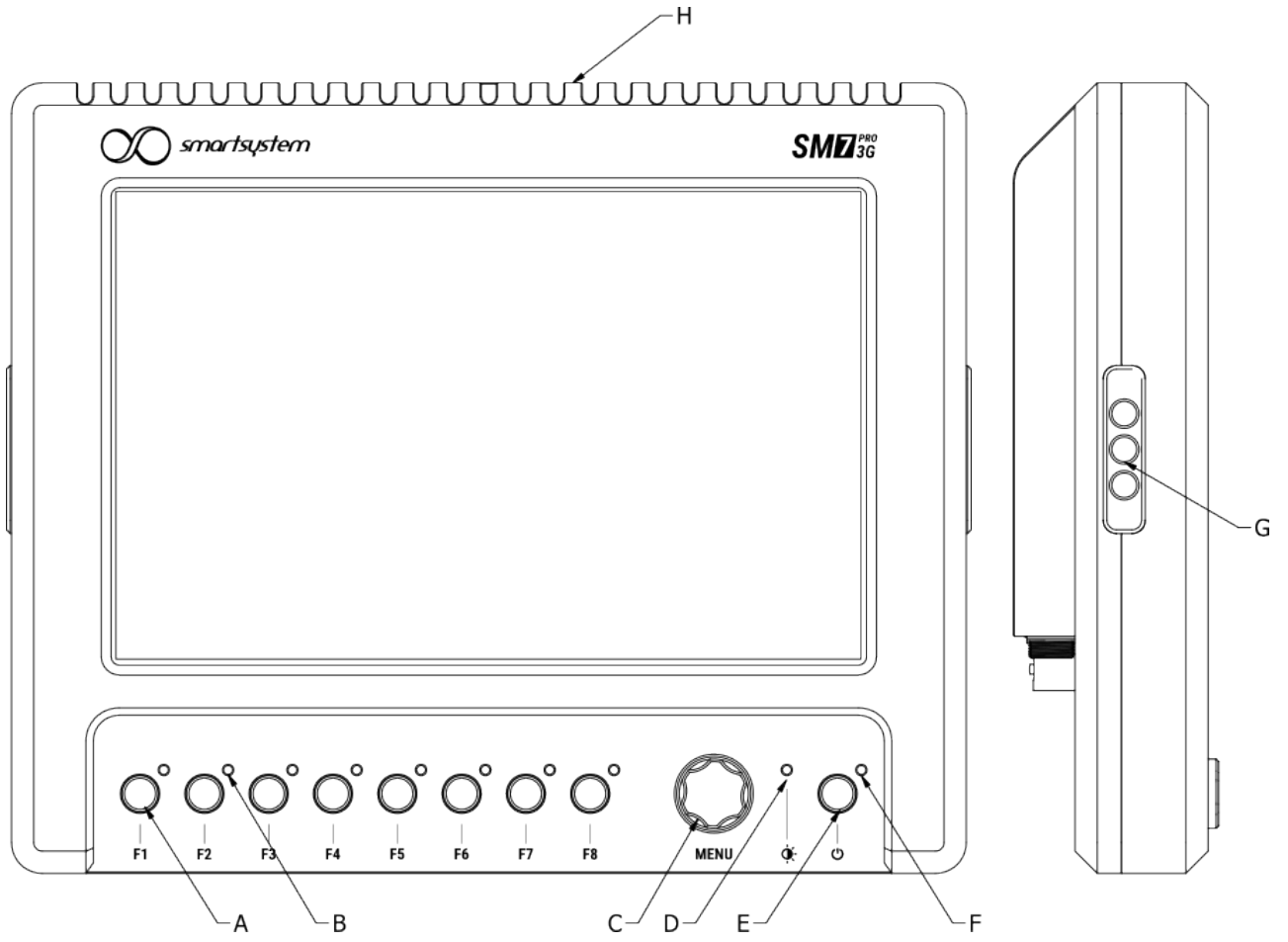

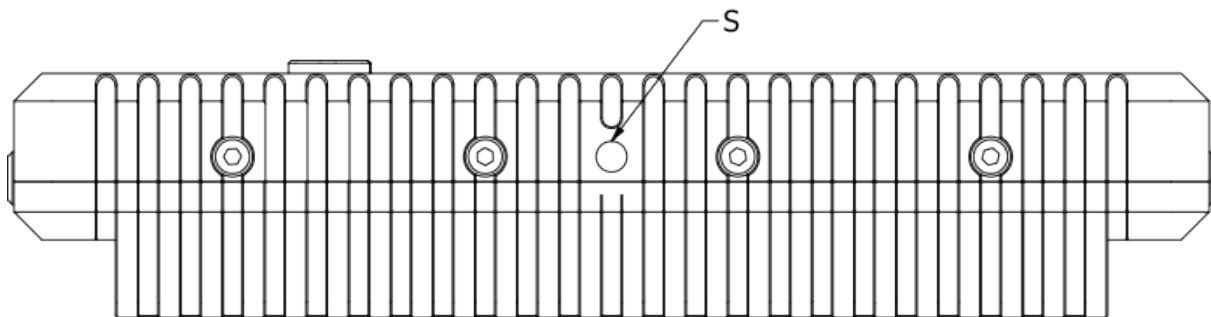
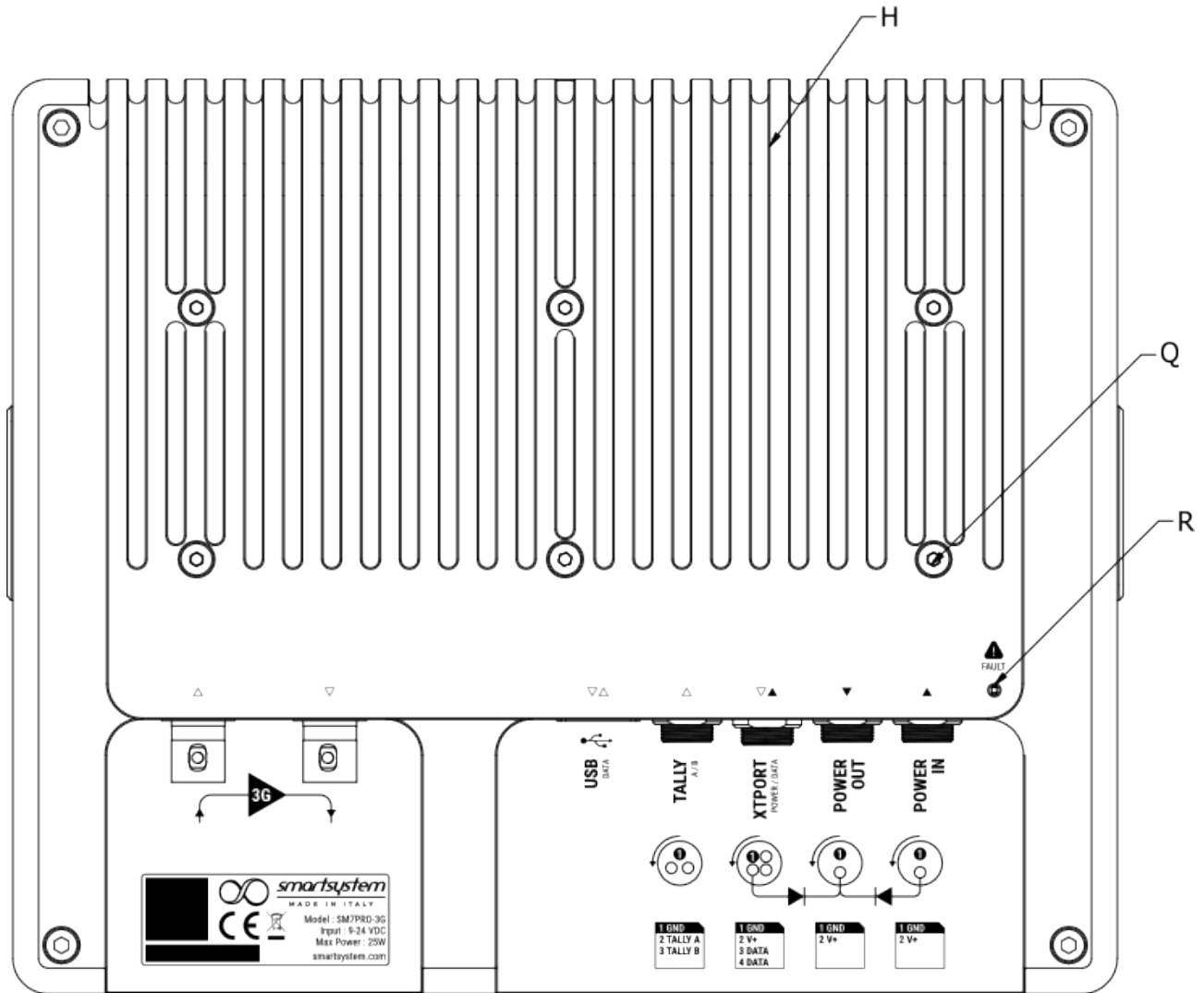
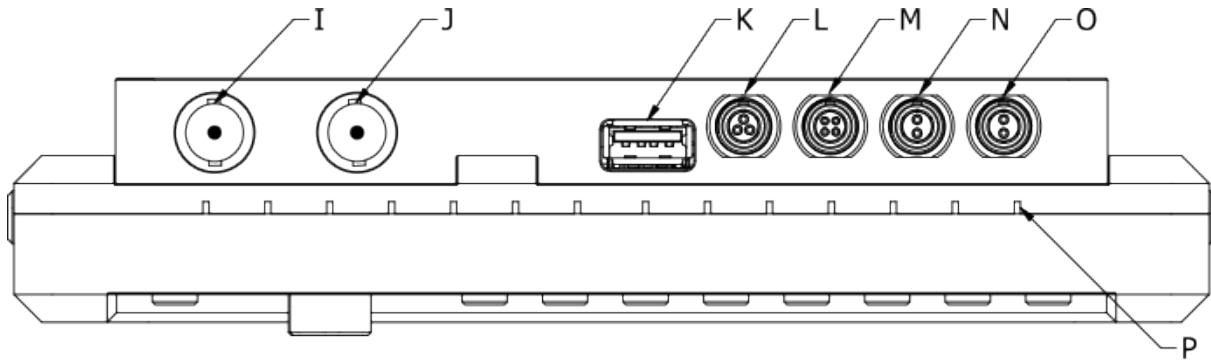

5 Register the product on SmartSystem Care Platform

It is highly suggested, if not mandatory, to register the product on the SmartSystem Customer Care portal reachable at the following LINK : <https://care.smartsystem.com>

After the registration, the portal will automatically inform you via email, once new firmware updates will be available offering an improved experience with your new SM7-PRO-3G.

NOTE : It is suggested to browse the link above via a PC or Mac browser avoiding mobile devices.

6 Electronic modular Design

SM7-PRO-3G is composed by various boards that work in harmony to offer to the user the best-in-class technology.

Is it possible to simply the whole ecosystem in two distinct systems

- COM Board : responsible to control the outer environment like data communication, power lines, light sensors, temperature sensors as well as interface the user to the main system via F1-F8 keyboard.
- LCD Board : responsible to process all the video signals to the LCD as well as process all the information from touch panel.

This approach, even if more complicated, grant to the product a higher degree of flexibility and possibilities of future expansion.

7 Powering the monitor

The input stage electronics of SM7-PRO-3G is able to accept a wide range of voltages ranging from 9VDC up to 34VDC and protect the monitor from

- Over voltage (over 34VDC)
- Under voltage (under 9VDC)
- Reverse polarity

The input connector (Par.4 Ref.O) is a standard 2 pin connector compatible with LEMO® 0B.302 connector.

The pinout follow the ARRI® standard where the negative is connected to the pin toward the (Red Reference) of the connector.

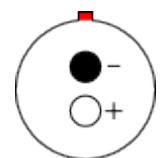

In case of fault situation, the system will automatically shutdown and FAULT LED will remain lit on. In case of sudden shutdown, before disconnect cable, check if the FAULT LED is on to get more information about the reason of shutdown

7.1 Daisy chain output

SM7-PRO-3G is equipped with a buffered power output (Par.4 Ref.N) able to grant a controlled output up to 5Amps.

The polarity is not changed or reversed respect the power input connector (Par.4 Ref.O) so take this information into account when you will connect other accessories to the output connector of the monitor.

8 Turning on the monitor







Even if turning on the monitor is a straightforward process, SM7-PRO-3G power button is not only a simple ON-OFF switch but rather a Smart Switch.

With a simple click of the power button (Par.4 Ref.E), it will directly power on the monitor.

At the same time, it is possible to power off the monitor with a double click for a controlled shutdown of the whole electronics where the various circuits will prepare themselves for a graceful shutdown. In case of trouble, it is possible to operate a forced shutdown, holding the power button for more than 3 seconds. In case the user is forced to operate the shutdown via this way, it is suggested to contact SmartSystem technical offices in order to troubleshoot the eventual problem.

8.1 Understanding Main Status LED

The main status LED, since RGB type, can inform the user of the current status of the whole system as reported below

Color	Appearance	Description
 Blue	Solid	Normal Operation / Default Thermal profile selected
 Amber	Solid	Normal Operation / Override Thermal profile selected
 Green	Solid	Firmware upgrading
 Green	Blinking	Committing upgrade to Flash
 Red	Solid	System in Bootloader mode
 Red	Blinking	System overheated. Automatic reduction of backlight

9 Booting process

Right after the user pressed the Power Button, the monitor will start executing the **booting process**. During this process, all the peripherals are checked and initialized showing to the user a welcome splash screen on LCD and a “breathing effects” on status LEDs.

During this period, the device is totally unresponsive.

Once the check process is complete, the monitor will automatically pass in **operational mode** shown to the user with the Main Status LED colored in Solid BLUE (as described in Par.7.1).

In case of problem of one of the internal peripherals, the Function Button LEDs will be colored in BLINKING RED with a specific pattern.



In case of ERROR, please contact a SmartSystem Technician reporting Serial Number of monitor and which Function Button LEDs are blinking in order to quickly diagnose the error.

10 Interacting with the Monitor

SM7-PRO-3G offers to the user two possibilities of interaction for maximum flexibility:

- via Main Knob
- via Touch screen

We designed this double opportunity since we know how hard could be working with a touch monitor in harsh environment (under rain that can be interpreted by the system as a voluntary touch command or in very cold environment where gloves can be tricky to use). In these cases, the “old school” knob is a life-saver.

10.1 Interaction with Main Knob

Based on the operating mode of the monitor, the main knob can absolve to various task based if the main menu is shown or not as summarized in the table below:

MAIN MENU NOT SHOWN

Operation	Result
Dialing CW	Increase the brightness of the panel
Dialing CCW	Decrease the brightness of the panel
Single Press	Open the Main Menu
Double Press	Activate / Deactivate the touch screen

MAIN MENU SHOWN ON SCREEN

Operation	Result
Dialing CW	Navigate Up>Down the menu items
Dialing CCW	Navigate Down>Up the menu items
Single Press	Select the highlighted option or enter the sub menu
Single Press	Step back from the sub menu up to the main menu
Long Press	Close the Main Menu

10.2 Interacting via Touch screen

In the case the Touch screen was enabled, the user can interact with the SM7-PRO-3G directly tapping or sliding on the LCD surface in a straightforward way.

The various operation can be summed up in the following table:

MAIN MENU NOT SHOWN

Operation	Result
Slide Up	Increase the brightness of the panel
Slide Down	Decrease the brightness of the panel
Double Tap	Open the Main Menu
Pinch to Zoom	Zoom on the image (only if a video signal is present)

MAIN MENU SHOWN ON SCREEN

Operation	Result
Single Tap	Activate the selected option
Slide over a control	Increase or decrease the corresponding control
Double Tap outside Main Menu	Exit from the Main Menu



11 Function buttons

Function buttons (Par.4 Ref.A) are programmable shortcut to the preferred feature offered by SM7-PRO-3G.

Basically, every function can be addressed to a specific button in order to have an extremely direct interaction with the system without loosing time dealing with touch option.

At every function button, it is co-related a specific RGB status LED (Par.4 Ref.B).

Pressing the corresponding function buttons, the user will be informed about the presence or not of an association between the button and monitor function with the following behavior:

Color	Appearance	Description
 Red	Blinking	No function associated to the corresponding button
 Green	Blinking	There is a function associated to this button
 * (R/G/B/W)	Solid	Function associated and activated

* The user has the ability to define his preferred accent with the corresponding LEDs Accent menu described later on this manual

11.1 Association between Monitor Function and Function Buttons

The association process between Monitor Function and Function Buttons is extremely straightforward. Just navigate the menu (as described later in this manual) and select which Function Button associate to the current Function like in the example below:

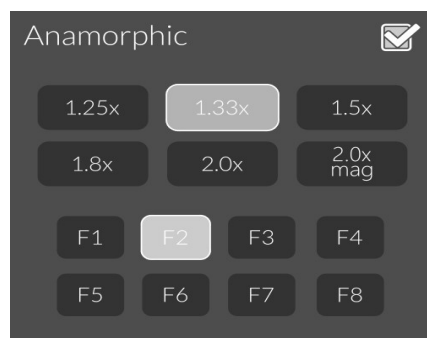

In this example, the user enabled the function "ANAMORPHIC" with the value 1.33x associating it to Function Button F2.

Please note that during the association process, the corresponding Function Button associated will the function will not be responsive since the graphic menu takes the precedence. At the same time, the Function Button LED will match exactly the status of the function. In the example above, since the ANAMORPHIC function is enabled, the F2 LED will be ON.

12 Navigating the menu

The main menu is composed by 6 Submenus:

- Setup
- Color
- Image
- Marker
- Assist
- Waves

12.1 Setup

The setup menu report all the function related to the basic settings of the monitor

12.1.1 LEDs Color

The user can select which accent set up for the Function Button LEDs once light on.

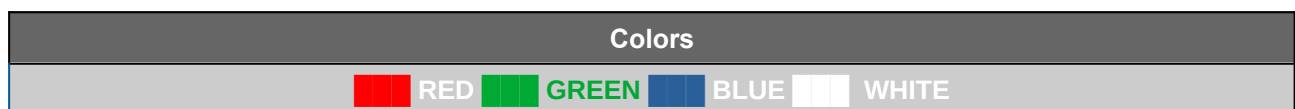

12.1.2 Backlight

This menu report the current backlight of the monitor. The user can change the value with a slider.

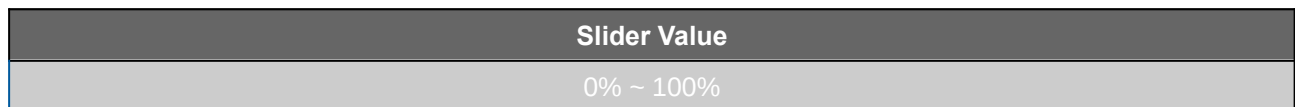

12.1.3 Auto Backlight

Auto Backlight is the exclusive feature of SM7-PRO-3G.

The integrated light sensor (Par.4 Ref.D) automatically inform the system about the environmental light amount.

Once defined a preferred value of backlight, the user can define the amount of intervention of the Auto Backlight depending by the amount of environmental light detected. Auto Backlight can be linked to one of the available Function Buttons

Quick Value Recall	Slider Value	Function Buttons
10 / 20 / ... / 100	0 ~ 100	F1 / F2 / ... / F8

12.1.4 Tally

It is possible to configure how to visualize on screen the TALLY Signal.

Style	Dimension	Transparency	Logic
Boxed / Corner	0 ~ 100	Solid / Transparent	Normal / InvA / InvB / Inverted

In case of BOXED option, a solid stroke on the perimeter of the frame will be shown on screen while the CORNER option will emphasize a solid stroke only on the corner of the frame.

The color of the stroke could be RED or GREEN based on which input are electronically closed on the tally input.

The logic menu let the user define if the input of Tally is Normal (opened means no signal) or Inverted (closed means no signal) and all the relative combinations.

During the setup, the tally stroke will be painted in Light Grey just for reference. The Color (RED or GREEN) will be used based on the input detected.

12.1.5 Video Alignment

With the video alignment option, the user can select where to see the tips icons on screen aligning the video image between three options.

Alignment of video signal
Top / Center / Bottom

12.1.6 Menu Setup

The user can select the On Screen Display appearance and Timeout

Transparency	Timout
OFF / Lo / Mid / Hi	No / 5s / 10s / 15s / 20s / 25s / 30s

12.1.7 Thermal

The thermal menu let the user configure the monitor for the specific environmental temperature. Please note that the selection is temporary and not stored for the next reboot.

Thermal Profile
Default / Override

Due to the fanless design, heatsink efficiency is directly tied to the temperature difference between the heatsink and the environment, making the working temperature crucial for effective cooling.

Selecting the **Default** profile enables the internal algorithm to maintain the LCD panel at the safest maximum temperature. It adjusts for temperature changes by automatically reducing the backlight to counteract heat buildup, ensuring optimal performance and longevity of the panel .

Selecting the **Override** option allows the system to closely monitor the LCD panel's temperature, ensuring it stays within the ultimate maximum limit. However, operating at this higher temperature may potentially reduce the monitor's lifespan. If you use the **Override** setting for extended periods, be sure to allow the device adequate cooling time to help mitigate any potential impact on its longevity.

On the menu, the user can also see the internal temperature (in °C / °F) of

1. Main CPU / FPGA Board
2. Com Board / Outer shell
3. Mean between the two temperatures above

12.1.8 Firmware

In this menu is it possible to know the firmware version of LCD Board as well as the COM Board. At the same time is it possible to execute a completely restore to **Default Settings**

NOTE : If the system will be power on in Bootloader Mode (later described in this manual), this menu will offer also to the user a recovery mode for firmware upgrade.

12.2 Color

In the color menu everything is related to the color management of the image

12.2.1 LUT Switch

Once loaded on the monitor, the user can straightforward select which LUT apply on the image shown on screen

12.2.2 LUT Import

To load one or more LUTs on the SM7-PRO-3G, it is necessary to use a FAT32 formatted USB pen and loaded with .cube LUTs. Once detected by the system, it is sufficient to tap on IMPORT (USB) button to execute the downloading of the files from the USB Pen to the monitor.

12.2.3 Brightness

It determines the overall luminance or lightness of an image. Adjusting brightness settings allows users to control the overall illumination of the display, ensuring optimal visibility in various lighting conditions.

NOTE : do not confuse Brightness with LCD Backlight (Ref.11.1.2)

Slider Value	Default Value
0 ~ 100	50

12.2.4 Contrast

Adjusting the contrast level enhances the distinction between light and dark elements, contributing to the overall visual impact and clarity of an image or video.

Slider Value	Default Value
0 ~ 100	50

12.2.5 Saturation

Adjusting saturation levels enhances or diminishes the purity and strength of colors. A higher saturation setting results in more vibrant and intense colors, while lower saturation produces a more muted or grayscale appearance.

Slider Value	Default Value
0 ~ 100	50

12.2.6 Hue

Adjusting the hue changes the dominant color in an image, shifting it along the color

spectrum.

Slider Value	Default Value
0 ~ 100	50

12.3 Image

In the Image menu everything is related to the image management of the input signal

12.3.1 Scan Mode

It is possible to select how to handle the Scan mode of the input signal

Scan Mode Options
Under Scan / Over Scan

12.3.2 Aspect Ratio

This menu handle the aspect ratio of the input signal associating it a direct shortcut to Function buttons

Options	Function Buttons
Auto / 16:9 / 16:10 / 4:3 / 5:4 / 2:1 / 1.85:1 / 2.35:1 / User defined	F1 / F2 / ... / F8

In case of "User defined" option, it is possible to define the following parameters

Width	Height
100% ~ 300%	100% ~ 300%

12.3.3 Crop & Zoom

This menu handle the zoom and the crop of the image reported on screen associating it a direct shortcut to Function buttons

Scale	Function Buttons
1.00x ~ 3.50x	F1 / F2 / ... / F8

Crop Left	Crop Right	Link Left - Right
0% ~ 50% / 100 %	0% ~ 50% / 100 %	ON / OFF

When the Link option is enabled, adjusting the Left value will automatically and proportionally change the Right value and viceversa.

Crop Top	Crop Bottom	Link Top - Bottom
0% ~ 50% / 100 %	0% ~ 50% / 100 %	ON / OFF

When the Link option is enabled, adjusting the Top value will automatically and proportionally change the Bottom value and viceversa.

NOTE: the user can interactively change the zoom value using touch panel and pinch gesture once the touch is enabled (Par.9.1).

12.3.4 Anamorphic

This menu handle the anamorphic desqueeze of the input signal reported on screen associating it a direct shortcut to Function buttons. It corrects the horizontal compression introduced by the lens, allowing the user to achieve the intended widescreen aspect ratio and maintain the distinctive cinematic qualities associated with anamorphic cinematography.

Options	Function Buttons
1.25x / 1.33x / 1.5x / 1.8x / 2.0x / 2.0x mag	F1 / F2 / ... / F8

12.3.5 Pixel to Pixel

This menu let the user to show on screen the input signal without any kind of manipulation associating it a direct shortcut to Function buttons. It ensures a one-to-one mapping between the pixels in the input signal and the pixels on the screen.

Options	Function Buttons
ON / OFF	F1 / F2 / ... / F8

12.3.6 Image Flip

Straightforward option to visualize on screen the image flipped associating it a direct shortcut to Function buttons

Options	Function Buttons
Horizontal Flip / Vertical Flip / 180°	F1 / F2 / ... / F8

12.3.7 Freeze

Straightforward option to freeze the image on screen associating it a direct shortcut to Function buttons

Options	Function Buttons
ON / OFF	F1 / F2 / ... / F8

12.4 Marker

In the Marker menu, the user can add to the images some markers to visually help him understanding better what to focus to. The user can also choose the colors of these markers.

12.4.1 Cinema Guides

Cinema guides assist the user in framing his shots according to specific aspect ratios, contributing to the overall visual aesthetics and cinematic quality of the film. This feature can be linked to a specific Function Button.

Values	Percentage
16:9 / 16:10 / 4:3 / 1.85:1 / 2.35:1 / 2.41:1 / 1.90:1 / 5:4 / 1.1.90 / User	0% / 25% / 50% / 75%

Transparency	Thickness
Solid up to Transparent via Slider	Adjustable via Slider

Color	Function Buttons
 Yellow / Magenta / LightBlue / Red / Green / Blue / White	F1 / F2 / ... / F8

When the User option is selected, two additional sliders appear on the screen, allowing the user to define custom values.

12.4.2 Safe Areas

Show on screen a convenient rectangle with specific dimensions and aspect ratio. This feature can be linked to a specific Function Button.

Values
16:9 / 16:10 / 4:3 / 5:4 / 1:1 / 1.91:1 / 4:5 / 9:16 / 1.85:1 / 2.35:1 / User

In case of “User” option, it is possible to define the following parameters

Width	Height	Thickness
50% ~ 100%	50% ~ 100%	Adjustable via Slider

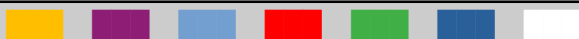
Color	Function Buttons
 Yellow / Magenta / LightBlue / Red / Green / Blue / White	F1 / F2 / ... / F8

12.4.3 Cross Hatch

Show on screen a convenient pattern of horizontal and vertical lines. This feature can be linked to a specific Function Button.

Values
3x3 / 4x4 / 5x 3 / 5x5 / 6x4 / 6x6 / 7x7 / 8x8 / 9x9

Transparency	Thickness
Solid up to Transparent via Slider	Adjustable via Slider

Color	Function Buttons
 Yellow / Magenta / LightBlue / Red / Green / Blue / White	F1 / F2 / ... / F8

12.4.4 Crosshair

Show on screen a Target style cross in the center of the monitor. This feature can be linked to a specific Function Button.

Slider Value
1 ~ 100

Once reached the 100 value, the crosshair is shown full screen.

Transparency	Thickness
Solid up to Transparent via Slider	Adjustable via Slider

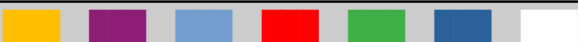
Color	Function Buttons
 Yellow / Magenta / LightBlue / Red / Green / Blue / White	F1 / F2 / ... / F8

12.5 Assist

In the Assist menu offers a comprehensive set of tools for precise and detailed video analysis. These functions collectively contribute to achieving sharp focus, optimal image clarity, exposure evaluation, composition assessment, and accurate color representation in your visual content.

12.5.1 Focus Assist

Focus Assist is an indispensable tool in cinematography, empowering filmmakers to achieve precision in focus for their shots. It provides a visual guide, ensuring that crucial elements are sharply defined, even in scenarios with narrow depth of field. This feature can be linked to a specific Function Button.

Level Value
1 ~ 10

Color	Function Buttons
 Yellow / Magenta / LightBlue / Red / Green / Blue / White	F1 / F2 / ... / F8

12.5.2 Sharpness

It refers to the clarity and distinctness of details in an image. Adjusting sharpness enhances the crispness of edges and fine elements, contributing to a clearer and more refined visual presentation. This feature can be linked to a specific Function Button.

Slider Value
1 ~ 20

Color	Function Buttons
 Yellow / Magenta / LightBlue / Red / Green / Blue / White	F1 / F2 / ... / F8

12.5.3 Zebra

It aids in exposure control by visually indicating areas of the image that may be overexposed. When enabled, zebra stripes appear on the overexposed portions of the frame, serving as a helpful guide for adjusting exposure settings to avoid losing detail in bright areas. This feature can be linked to a specific Function Button.

Slider Value
0 IRE ~ 100 IRE

Color	Function Buttons
 Yellow / Magenta / LightBlue / Red / Green / Blue / White	F1 / F2 / ... / F8

12.5.4 CheckField

It is a display mode that helps filmmakers assess various aspects of their image. This allows users to view the image with specific color channels emphasized, aiding in the evaluation of exposure, contrast, and color balance. This feature can be linked to a specific Function Button.

Color	Function Buttons
 Yellow / Magenta / LightBlue / Red / Green / Blue / White	F1 / F2 / ... / F8

12.5.5 False Color

This feature represents different levels of exposure and focus using distinct colors, making it easier to identify which parts of the image are in focus. This feature can be linked to a specific Function Button.

Options	Function Buttons
ARRI / Sepctrum	F1 / F2 / ... / F8

12.6 Waves

The "Waves" menu on SM7-PRO-3G provides a suite of tools designed for in-depth video analysis and monitoring. These tools contribute to achieving optimal exposure, color accuracy, and overall image quality in your visual content.

12.6.1 Waveform

A waveform monitor is a tool used for analyzing and monitoring the luminance levels of a video signal. It displays a graph representing the brightness (luminance) values of an image over time. This feature can be linked to a specific Function Button.

Options	Function Buttons
RGB / YUV / Y	F1 / F2 / ... / F8

12.6.2 VectorScope

It assists in analyzing and monitoring the color information within a video signal. It provides a graphical representation of color information in an image, helping the user to achieve accurate and consistent color reproduction. This feature can be linked to a specific Function Button.

Function Buttons
F1 / F2 / F3 / F4 / F5 / F6 / F7 / F8

12.6.3 Y Istogram

This feature is particularly useful in cinematography and photography to achieve optimal exposure and maintain the desired tonal balance in your images or video footage. This feature can be linked to a specific Function Button.

Function Buttons
F1 / F2 / F3 / F4 / F5 / F6 / F7 / F8

12.6.4 RGB Istogram

It is a graphical representation of the distribution of color values in an image across the red, green, and blue color channels. It provides a separate histogram for each color

channel, allowing you to assess the balance of colors in your image or video. This feature can be linked to a specific Function Button.

Function Buttons
F1 / F2 / F3 / F4 / F5 / F6 / F7 / F8

13 Zen PRO

This menu allows the user to configure and obtain information about the Zen PRO device connected to the XTBus.

13.1 System

The System menu displays all the information of the Zen PRO detected on the XTBus, including:

- Serial Number
- Firmware Version
- Bootloader Version



Additionally, you can associate a function button, such as F1 or F8, to enable or disable the on-screen visualization of the Zen PRO axis. This is based on the options defined in the axis menu (refer to Par. 13.2).

13.2 Axis

In this menu, you can select which axes to display on the screen and arrange their order, which is organized **bottom-up**.

Changing the screen alignment (as described in Par. 15.1.2) between Top, Center, and Bottom affects where the axes are displayed using the "empty space" left by the 1080px vertical resolution of the input signal compared to the 1200px available on the screen.

It's important to note that you can display up to three axes, whether of the same type or different types, and each axis can be configured independently.

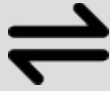
Icon	Description
	Roll Axis
	Tilt Axis
	Yaw Axis
	Side to Side acceleration

13.3 Style

Once defined the type and the number of axis the user want to visualize as described on the previous paragraph, it is possible to style it separately using the following options:

Visualization
Dot / Bar

The dot visualization creates a moving dot, while the bar option displays a straightforward bar extending from the center value of the corresponding axis.

Direction
Horizontal / Vertical

The direction setting allows the user to display each specific axis either horizontally or vertically. While the Tilt axis is typically associated with vertical visualization and Roll or Side-to-Side acceleration with horizontal, the choice of the best visualization is entirely up to the user.

Orientation
Normal / Inverted

While some users prefer to see a moving dot or bar that mimics the natural movement of a spirit bubble, others prefer a view that indicates where the system is inclined to automatically compensate for the axis being affected.

13.4 Safe Areas

For each axis enabled, the user can define a safe area represented by two vertical lines on the corresponding axis.

These lines are extremely helpful for keeping the user focused on the desired values.

The values are expressed as a total amount; for example, if set to 10°, the Safe Area spans a total of 10°, meaning +/- 5° from the center value.

13.5 Resolution

Resolution defines the total span of the corresponding axis.

For example, a resolution of 90° means a total span of 90°, or +/- 45°.

Once this limit is reached, the corresponding axis, whether displayed as a bar or dot, will be shown in red.

13.6 Speed

As for the other parameters, even speed can be tuned and optimized with the following options:

Speed Values
Realtime / Fast / Medium / Slow / Sloth

14 Firmware Upgrade

SM7-PRO-3G can be upgraded directly by the user using the software BURNER freely downloadable from the SmartSystem website at the following link : <https://www.smartsystem.com/software/>.

Burner software is compatible with XTDevices only from release 3.x onwards.

Since SM7-PRO-3G is an XTBus device, is it possible to connect it to a standard PC or Mac via the XTDongle in bundle with the product.

In order to verify and upload a new firmware to your SM7-PRO-3G

1. Power on the monitor with a fully charged battery or with a reliable source with a DC Line with a voltage range between 9VDC and 34VDC without any signal input
2. Connect XTDongle to SM7-PRO-3G on the XTPort connector using the 4 pin connector
3. Connect the XTDongle via the USB Type A connector
4. Start Burner software

The system will automatically recognize your product and inform you whether or not it is possible to install a new firmware update for the XTDevice connected.



During the firmware update procedure, never turn off or disconnect the product before Burner completes the firmware upload process.

15 Maintenance

Do not use alcohol or other solvents nor detergents to clean your SmartCAM SM7-PRO-3G. To clean metal components, we recommend you to use a paper towel lightly soaked in distilled water. Make sure no water drops reaches the inside components of SmartCAM SM7-PRO-3G.

16 Disposal

Dispose of your SmartCAM SM7-PRO-3G in accordance with current regulations. Address to special authorities or companies in charge of scrapping metallic materials and waste disposal.

Pursuant to Article 13 of the Italian Legislative Decree no. 151 of 25 July 2005, "Implementation of Directives 2002/95/EC, 2002/96/EC and 2003/108/EC regarding the reduction in use of dangerous substances in electrical and electronic equipment as well as waste disposal".

The user must therefore dispose of the product in question at suitable recycling centers for electronic and electro-technical waste, or he/she must turn the used product over to the retailer when buying a new equivalent product, on a one-to-one basis. Separate waste collection allows used equipment to be recycled, treated and disposed of without negative consequences for the environment and health, and it allows the materials in the equipment to be recycled. Illegal dumping of the product by the user entails application of the administrative sanctions stated in the Italian Legislative Decree No. 22/1997 (Article 50 et seq of the Italian Legislative Decree No. 22/1997).

17 Warranty

SmartSystem Srl headquarter is located in Via del Commercio, 22F, 61032 FANO(PU), ITALY. Smartsystem main brand and all the other brands associated with it are property of SmartSystem Srl.

Your SmartSystem equipment is guaranteed against any manufacturing or material defects for 12 months from the date of delivery to the customer. Warranty will cover any functioning issues related to manufacturing or material faults.

In this case, the company reserves the right to decide whether eliminating the defect or providing the customer with a new product.

Any claims due to manufacturing or materials faults must be communicated by the customer, upon presentation of the warranty card, properly completed, or of a proof of purchase.

The warranty, which will expire after 12 months, will not be extended either by a complaint, or by subsequent executions. Damage caused by accident, misuse, do-it-yourself repairs or modification, repair by unauthorized service center, static charges or mechanical damages is not covered by the warranty.

Furthermore, warranty won't be valid neither in case the warranty card is arbitrarily modified.

Repairs must be made only by authorized service centers.

ALWAYS REQUEST THE RMA NUMBER BEFORE SENDING US THE PRODUCT