

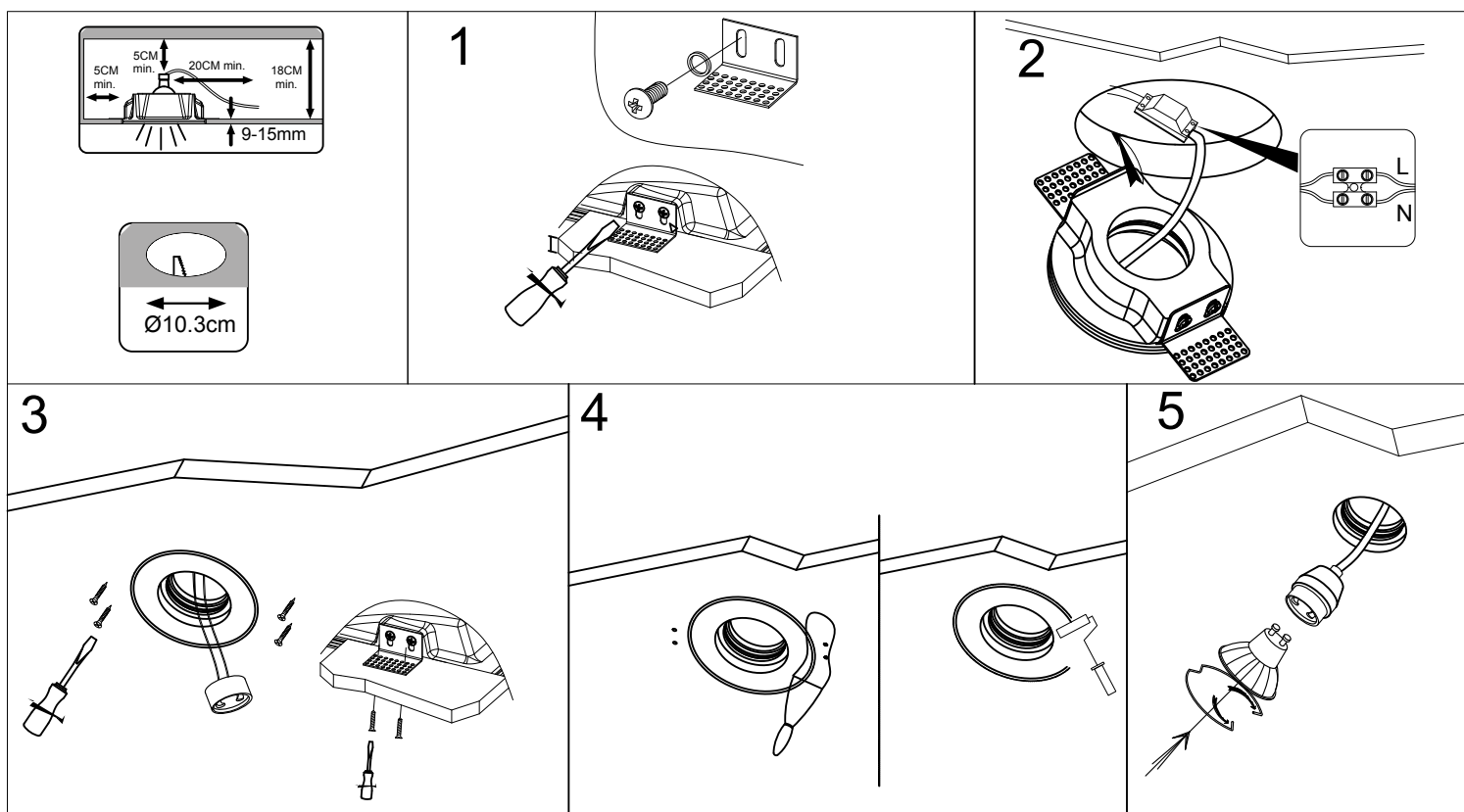

100-240V | GU10 | IP20 | GYPSUM | MAX. 35W

Installation Instructions

- Disconnect the electricity before installation
- Cut the hole (\varnothing 10.3 cm)
- Adjust the height of the mounting bracket according to the ceiling thickness (figure 1)
TIP: make sure to have 3-4mm plaster height for smooth finish
- Connect the GU10 lampholders (figure 2)
- Put the gypsum fitting into the ceiling hole and fix using screws (figure 3)
- Finish with plaster and paint (figure 4)
- Insert GU10 lamps (figure 5)
- Switch on the main electricity



Warnings:

1. Disconnect the electricity before installation
2. Make sure that the product is installed properly before connecting to electricity
3. Do not cover the fitting
4. Maintenance and installation should only be carried out by a professional electrician



View this product and manual
online by scanning this QR code