

QuietTime[®] ProRecord[®]
ProScan

User Guide
March 2018



A product of

PianoDisc

4111-A North Freeway Boulevard
Sacramento, CA 95834, USA

© 2014 Burgett Inc. You are not allowed to completely or partially copy this user guide without obtaining explicit, written authorization from PianoDisc, a member of the Burgett Inc. Group of companies. QuietTime, PianoDisc and Burgett Inc., retains the right to modify their product designs and product specifications at any time without giving prior notice.

CE - Certification

The *QuietTime* system easily satisfies the basic requirements stipulated by all the relevant directives* issued by the European Union. The stipulated conformity process has been completed.

*) At the present moment these are 2006/95/EC and 2004/108/EC



Electrical and electronic products must not be disposed of with normal household waste.
Dispose of the product, at the end of its service life, in accordance with valid statutory

Safety and warning instructions
IMPORTANT! Please read these instructions first!



IMPORTANT INFORMATION: Complete safety when using the system is only guaranteed by PianoDisc if it has been installed correctly and is used correctly. Do not make any modifications of your own or encourage others to modify any part of the QuietTime systems, if PianoDisc has not specifically approved the modification.

Read these instructions before operating the system!

Interference from other devices on the same circuit may cause an unpleasant pop when the devices are switched on or off. Whenever possible, connect the QuietTime Silent System to a dedicated outlet. The PianoDisc warranty does not cover interference caused by other devices, which typically have inadequate filtering circuits. To avoid unwanted popping noises, avoid switching other devices on or off while the Silent System is powered.

Other safety and installation instructions

You will find information in this list that covers possible personal injuries, electrical shock and causes of fire. WARNING! You must always abide by the basic precautions, including the following instructions, when using electrical equipment:

1. Read all of the instructions before using the product for the first time.
2. The product must be connected to the type of power supply stipulated in this user guide or on the product itself.
3. Never open the QuietTime System case under any circumstances.
4. Power is supplied through the plug. The system should only be connected to an electrical socket that is suitable for use with the attached plug.
5. You should always try to keep the power cable a safe distance away from other objects. Make sure the cable is not:
 - Tangled
 - Placed in a frequently used area
 - Trapped beneath the piano
6. Do not position your piano and the QuietTime System in a location that is in direct sunlight or where they are subjected to water, humidity or hot and cold airflows.
7. Your QuietTime System should be disconnected from the electrical outlet if it is not used for a long period of time.
8. Only an authorized service agent should be contacted if your system needs repairing.
9. This product can generate volume levels that cause permanent loss of hearing when used alone or in conjunction with an amplifier, headphones or loudspeakers. Consequently, never run the QuietTime System for too long at a loud volume or even at a volume that is painful on the ears. Please visit an ear specialist before using your QuietTime System again if you experience a loss of hearing or if you experience ringing in your ears.
10. The product must be installed so that there is adequate ventilation.
11. Make sure no objects or liquids are able to leak into the system through the openings in the top of the equipment.
12. The product must always be serviced by a qualified service technician, if:
 - a) The electrical cable or plug is damaged; or
 - b) Foreign objects or liquids spill into the system through the openings in the top; or
 - c) The system was left out in the rain; or
 - d) The system does not appear to work normally or it shows clear signs of working differently; or
 - e) The system has been dropped or severely jolted, or the top of the equipment has been damaged.

General user information

- Leaving the QuietTime System's plug perpetually plugged into an electrical outlet causes it to continually draw power (approx. 0.5 Watt) and generate a small amount of heat. Disconnecting the piano's plug from the electrical supply will completely isolate the unit unless the tone generator also has its own power supply.
- Ensure the tone generator is always adequately ventilated from above, below and the rear. The QuietTime System's tone generator must never be placed on a soft surface, such as a cushion or a towel. Never put any objects or containers on top of the tone generator.
- If the QuietTime System does not respond in any way to your controls, as described in this manual, disconnect the unit from the power supply and contact your piano dealer or PianoDisc.

U.S.A. information – FCC

NOTE: This equipment has been tested and found to comply with the limits of a Class B digital device in accordance with Part 15 of the U.S.A. FCC rules. These limits are designed to provide reasonable protection against harmful interference when used in a private residence. This equipment generates, uses and can radiate radio frequency energy and might cause harmful interference to radio communications if not installed and used in compliance with the instructions given in this user guide. However, there is no guarantee that interference will not be generated from a specific installation in rare cases. If this system does cause harmful interference to radio and TV reception, which can be determined by turning the system on and off, the user is encouraged to try to suppress the interference by using one or more of the following measures:

- Readjust the receiving antenna.
- Increase the distance between the system and the receiver.
- Connect the system's plug to a power outlet that is different from the one the receiver is using.
- Contact your dealer or an experienced radio/ TV technician for further help.

WARNING! Changes or modifications made to the electrical equipment that have not been expressly approved by the manufacturer (PianoDisc) might void the user's right to operate the equipment.

Content

Important! You will find the safety and warning instructions on pages 3 and 4 in this user guide.
Please read these instructions before you use your QuietTime System.

Chapter 1 About QuietTime ProRecord & ProScan

- 6 Welcome
- 6 Return your registration
- 6 Warranty

Chapter 2 Controls

- 7 ProRecord Control Box - front panel
- 8 ProRecord Control Box - back panel
- 8 ProRecord Control Box - right side
- 9 ProScan Control Box – front panel
- 9 ProScan Control Box – back panel
- 10 Pro Scan Control Box – right side

Chapter 3 Quick Start Information

- 11 Before you start
 - 11 IOS ProRecord App
 - 11 Switching on
 - 11 Activating the stop rail
 - 11 Plugging in headphones
 - 11 Volume control
 - 11 Selecting an instrument
 - 11 Switching off
- 11 Deactivating the stop rail

Chapter 4 Operation

- 12 How to play a demo song
- 12 List of Demo Songs
- 13 Selecting Instruments
- 13 Using the TONE-button
- 13 Using the TONE-button in conjunction with piano keys
- 14 Instruments available
- 15 Instruments and available effects
- 16 Effect Settings
- 16 Reverb
- 17 Chorus / Rotary Speaker
- 18 Delay
- 19 Transpose
- 20 Reset all effect settings
- 21 Metronome
- 21 Metronome ON/OFF
- 21 Metronome setup
- 22 Piano keys needed for metronome setup

- 23 Recording and Playback
- 23 Record instructions
- 23 Delete a recorded song
- 24 Playback instructions
- 25 Changing the playback tempo of a recorded song

Chapter 5 Adjustments and Configurations

- 26 Note repeat limit
- 27 Tuning (Adjusting the pitch)
- 28 Touch control (Adjusting the touch)
- 29 Pedal ON position
- 30 Pedal resolution
- 31 Key depth
- 32 Continuous note-on
- 33 Black keys volume control
- 34 Volume control for individual keys (Bass keys)
- 35 Volume control for individual keys (Treble keys)
- 36 Reset to factory defaults
- 37 Initial setup instructions
- 38 Sensor re-calibration
- 39 Automatic sensor calibration

Chapter 6 iOS Application

- 40 Using the App
- 40 Connecting to iOS device
- 40 Sounds & Effects
- 40 Metronome
- 41 Recording & Playback
- 41 Demo Songs
- 41 Adjustments

Appendix: Technical Information

- 42 About MIDI
- 44 MIDI (Connecting to other device)
- 44 MIDI Implementation chart
- 45 Technical specifications
- 46 Troubleshooting
- 47 PianoDisc Contact Information

Chapter 1 About QuietTime ProRecord & ProScan

Welcome

Welcome to QuietTime, the most advanced product in its class. QuietTime combines the original touch of an acoustic piano with current digital piano technology. This gives you the perfect combination from both worlds!

With your QuietTime ProRecord System you can:

- Still play your acoustic piano as usual;
- Convert your acoustic piano into a digital piano by simply moving a single lever;
- Play and practice the piano without disturbing others;
- Enjoy a wide selection of excellent instrument tones;
- Use your acoustic piano as a MIDI controller*;
- Can be used wirelessly with Bluetooth MIDI
- Record and play back a piano performance.

The ProScan system differs from the ProRecord in that it has no sound card so the instrument tones are not available. It is designed to be used with an external device such as an iPad, Computer, or MIDI controller to generate sounds. When connected to a PianoDisc iQ system, it can record and play back an acoustic piano performance.

Return registration

Please take a moment to complete the following information. Return the information to us by mail or email. Our mail and email addresses are listed in the *Specifications* appendix.

Please send us:

1. A copy of the invoice supplied with your QuietTime System.
2. A letterhead with your address and,
3. A note with QuietTime System's model name and serial number. (The name of the system is on the title page of this manual and the serial number is listed on the QuietTime System's control unit.)

Warranty

Your QuietTime System comes with a five-year warranty. PianoDisc's warranty covers any damage arising from normal system use.

Not covered by the warranty are: consumable parts and any damage caused by incorrect use or foreign objects (e.g. water damage, fire or opening the case). PianoDisc exchanges **defective** parts free-of-charge and supplies parts needed to make repairs deemed necessary. An authorized PianoDisc dealer must undertake any repairs made to a QuietTime System.

ProRecord Controls

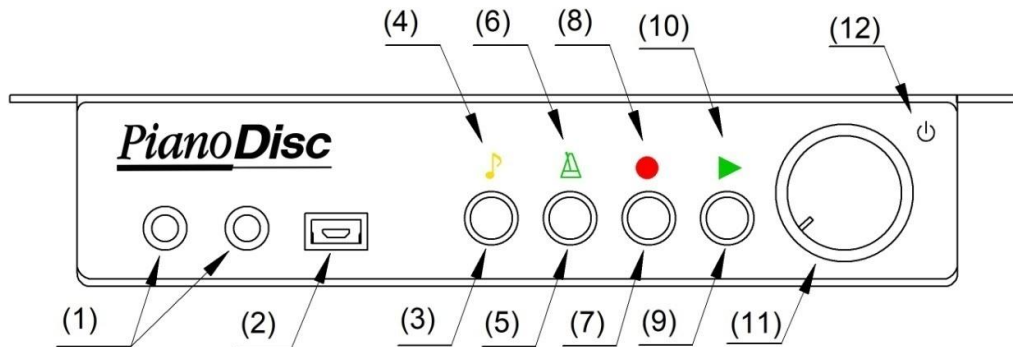

ProRecord Control Box – Front Panel

(1) Headphone Jacks –

Connections for up to two stereo headphones. **Note:** A headphone connected to the left jack mutes the line out jacks on the back of the control box.

(2) USB Mini B Jack –

Used for connection to a computer or other USB device.

(3) Tone Select Button –

Selects the 8 main instruments as follows: Piano, Bright Piano, Mellow Piano, FM Electric Piano, Church Organ, Warm Organ, Percussive Organ

(4) Tone LED –

Flashes when an instrument is selected. Flashes when a key or pedal is played. Flashes at the set tempo of the metronome when selected.

(5) Metronome –

Controls metronome functions; Start/Stop, set-up.

(6) Metronome LED –

Indicates that the Metronome is in use.

(7) Record Button –

Controls Start/Stop of record function.

(8) Record LED –

Indicates when system is recording.

(9) Play Button –

Controls Start/Stop of playback function.

(10) Playback LED –

Indicates when system is in playback mode.

(11) Power/Volume control –

Push to turn power on or off. Rotate to control volume of headphones and line out.

Note: Power should be turned off after each use

(12) Power Indicator LED –

Indicates when power is turned on. Flashes when connected to a Bluetooth device. (iPad or iPhone)

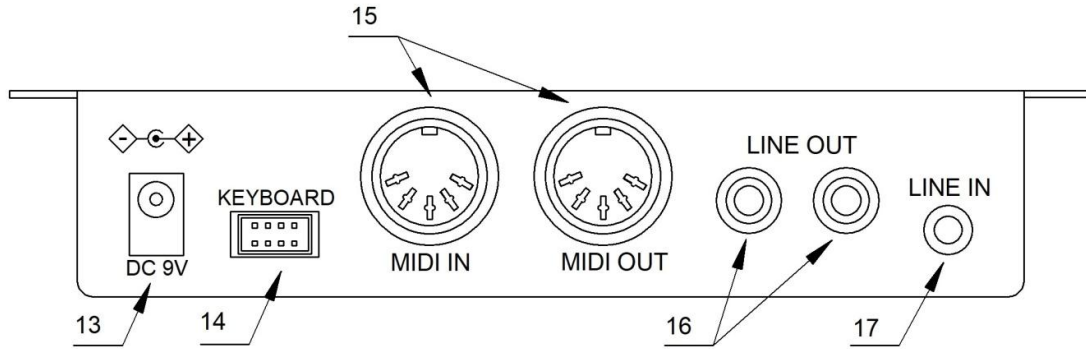

ProRecord Control Box – Back Panel

(13) DC9V –

For DC power adapter

Caution: To avoid damage to the unit, use only power adapters of the proper voltage (9VDC out).

Note: If power is supplied from the EXT connector (on side panel), do not use a DC adapter.

(14) Keyboard –

For connecting the key sensors to the control box

(15) MIDI IN / MIDI OUT –

For connecting to an external MIDI device or computer

(16) Line Out –

RCA jacks for connecting to an external stereo system.

(17) Line In –

For mixing sound produced by an external audio device

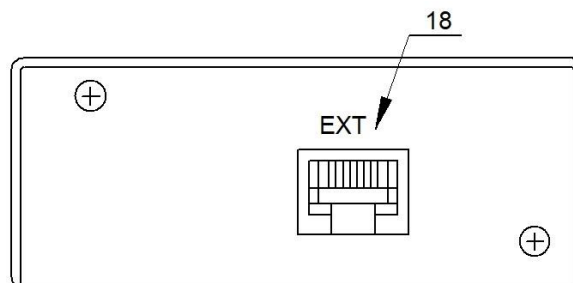

ProRecord Control Box – Right Side

(18) EXT Jack – External connector

For connecting to a PianoDisc iQ system. Contains a MIDI interface and power input from the PianoDisc system.

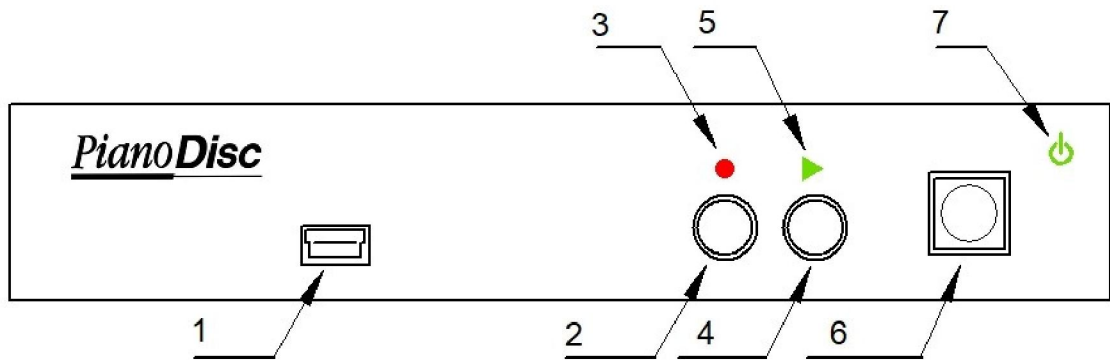

ProScan Front Panel

- (1) **USB Mini B Jack** - Used for connection to a computer or other USB device.
- (2) **Record Button** - Controls start/stop of record function
- (3) **Record LED** - Indicates when system is recording
- (4) **Play Button** - Controls start/stop of play back function
- (5) **Play LED** - Indicates when system is in play back mode
- (6) **Power Button** - Push to turn power on and off
- (7) **Power LED** - Indicates when power is on. Flashes when connected to a Bluetooth device

Chapter 3 -

NOTE: The was installec

Before you

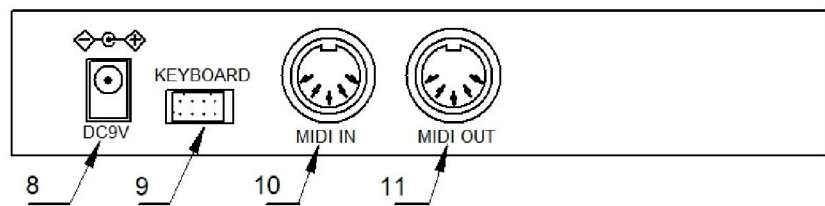

when it
aptor or

Proscan back panel

- (8) **DC 9V** - For DC power adaptor
Caution: To avoid damage to the unit, use only power adapters of the proper voltage (9VDC out).
Note: If power is supplied from the EXT connector (on side panel), do not use a DC adapter.
- (9) **Keyboard** - For connecting to the key sensor strip
- (10) **MIDI In** - For connecting external MIDI device.
- (11) **MIDI Out** - For connecting external MIDI device.

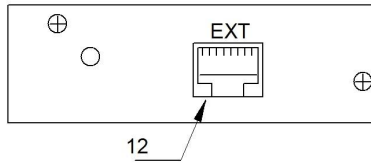

ProScan right side

(12) EXT Jack – External Connector

For connecting to a PianoDisc iQ system. Contains a MIDI interface and power input from the PianoDisc system.

NOTE: Many of the procedures in this manual that pertain to ProRecord will also apply to ProScan. The main exception is that there is no access to any of the sounds or sound effects that are built into the ProRecord system.

Chapter 3 – Quick Start Information

NOTE: The following information assumes that the system has already been set-up initially when it was installed. If this has not been done, see “Initial set-up instructions” in chapter 5.

Before you start

Is the correct power supply available?

Be sure the power is connected, either from an AC adaptor or from a PianoDisc external system.



iOS App – A free app is available for iOS devices (iPhone, iPad, etc.) from the Apple App store that can be used to control all the features of the ProRecord and ProScan

The App provides an alternative and much more convenient method for controlling the various features. See Chapter 6 for details.

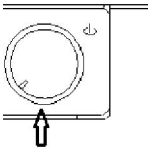

Switching on – Turn the power on by pressing the “POWER / VOLUME” button. Do not press any keys or pedals while powering on.

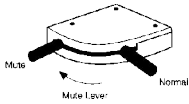

Activating the stop rail – Move the lever (beneath the piano keyboard) into the “Mute” position.

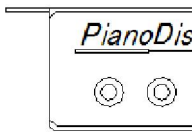

Plugging in and wearing the headphones. Plug your headphones into one of the headphone jacks on the QuietTime control box. Then put the headphones on.

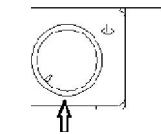

Volume – Play something on the piano. Adjust the headphone’s volume using the volume control. Establish a comfortable listening volume level.

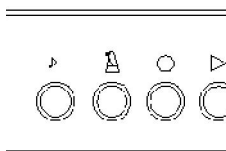

Selecting an instrument – Select the desired instrument using the “TONE” button.

Playing the piano. Play the piano as normal.

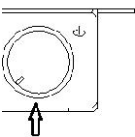

Switching off – Press the power button gently.

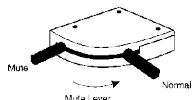

Deactivating the stop rail. Move the lever on the beneath the piano keyboard into the *Normal* position.

Selecting Instruments (not available on ProScan)

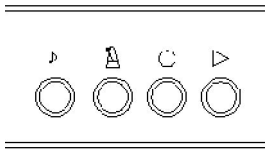

TONE button – 8 different instruments can be selected by pressing the “TONE” button on the control box. Each push of the “TONE” changes to the next instrument in sequence as follows:

- Piano
- Bright Piano
- Mellow Piano
- Electric Piano
- FM Electric Piano
- Church Organ
- Warm Organ
- Percussive Organ

Note:

A sample of each instrument will sound with each push of the “TONE” button.

Selecting Instruments

Using the “TONE” button in together with the pianos keys- 88 different instruments can be selected using the “TONE” button in conjunction with the piano keys (including the 8 instruments above) together

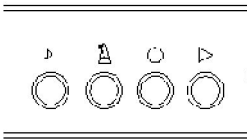

TONE button + Piano key –

Press and hold the “TONE” button.



Then press one of the piano keys for the instrument desired (see chart of instruments on following page). A sample of each instrument will sound with each key pressed. Release the “TONE” button once you have selected an instrument.

Notes:

- If power is turned off, the instrument will return to piano when power is turned on again
- Some of the instruments have pre-set effects (such as chorus & reverb) as part of their default setting.
- The rotary speaker effect is pre-set on the following instruments: Warm Organ, Percussive Organ, Drawbar Organ 1, Drawbar Organ 2, Rock Organ. When these instruments are selected, the damper pedal acts as a switch which changes the speed of the rotary effect.

The eight instruments that are accessed with the “TONE” button can be changed to any of the 88 instruments using the following procedure:

- Select the instrument from the “TONE” button that you want to replace
- Hold the “TONE” while selecting the desired instrument from the piano keys.
- Press the “RECORD” button
- Release the “TONE” button

To return to the default 8 instruments, use the following procedure:

- Press & hold the “TONE” button
- Press the “PLAY” button

Instruments available

*Piano 1 (normal)
*Piano 2 (bright)
*Piano 3 (Mellow)
Piano + strings
Piano 1 + choir
Bright Piano + Reverb
*Electric Piano 1
*FM Electric Piano
Harpsichord
*Church Organ
*Warm Organ
*Percussive Organ
Electric Piano 2
Honk-tonk Piano
Pan Rhodes
Clavinet
Celesta
Glockenspiel
Music Box
Vibraphone
Santur
Drawbar Organ 1
Drawbar Organ 2
Rock Organ
Small Church Organ
Reed Organ
French Accordion
Harmonica
Bandoneon
Acoustic Guitar (nylon)
Acoustic Guitar (Steel)
Electric Guitar (Jazz)
Chorus Guitar
Overdrive Guitar
Distortion Guitar
Acoustic Bass
Finger Electric Bass
Slap Bass
Synth Bass
Violin
Cello
Tremelo Strings
Harp
Stings

1	2	3	4	5	6	7	8	9	10	11	12	13	14	15	16	17	18	19	20	21	22	23	24	25	26	27	28	29	30	31	32	33	34	35	36	37	38	39	40	41	42	43	44
---	---	---	---	---	---	---	---	---	----	----	----	----	----	----	----	----	----	----	----	----	----	----	----	----	----	----	----	----	----	----	----	----	----	----	----	----	----	----	----	----	----	----	----

Base end of keyboard

Slow Strings
Strings + Horn
Synth Strings
Choir
Choir 2
Synth Voice
Trumpet
Trombone
Tuba
French Horn
Brass + Trumpet
Synth Brass 1
Synth Brass 2
Synth Brass 3
Synth Brass 4
Soprano Sax
Alto Sax
Tenor Sax
Baritone Sax
English Horn
Bassoon
Clarinet
Piccolo
Flute
Recorder
Pan Flute
Ocarina
Synth Lead 2 (sawtooth)
Synth Lead 5 (charang)
Synth Lead 6 (voice)
Synth Lead 8 (bass + lead)
Synth Pad 2 (warm)
Synth Pad 3 (polysynth)
Synth Pad 4 (choir)
Synth Pad 5 (bowed)
Synth Pad 7 (halo)
FX 3 (crystal)
FX 4 (atmosphere)
FX 5 (brightness)
FX 7 (echo)
Sitar
Koto
Bagpipe
Steel Drums

45	46	47	48	49	50	51	52	53	54	55	56	57	58	59	60	61	62	63	64	65	66	67	68	69	70	71	72	73	74	75	76	77	78	79	80	81	82	83	84	85	86	87	88
----	----	----	----	----	----	----	----	----	----	----	----	----	----	----	----	----	----	----	----	----	----	----	----	----	----	----	----	----	----	----	----	----	----	----	----	----	----	----	----	----	----	----	----

NOTE:

Instruments marked with an asterisk can also be selected with the "TONE" button alone.

Instruments and available effects

Key	Instrument	Chorus	Note	Key	Instrument	Chorus	Key	Instrument	Chorus
1	Piano 1			31	Steel Guitar	o	61	Alto Sax	
2	Bright Piano			32	Jazz Guitar	o	62	Tenor Sax	
3	Mellow Piano			33	Chorus Guitar	o	63	Baritone Sax	
4	Piano 1 + Strings	o	* SlowSTR	34	Over Drive Guitar	o	64	English Horn	
5	Piano 1 + Choir	o	SlowChoir	35	Distortion Guitar	o	65	Bassoon	
6	Space Piano	o		36	Acoustic Bass		66	Clarinet	
7	Electric Piano	o		37	Finger Bass		67	Piccolo	
8	FM Electric Piano	o		38	Slap Bass		68	Flute	
9	Harpichord			39	Synth Bass 2		69	Recorder	
10	Church Organ			40	Violin		70	Pan Flute	
11	Warm Organ		**Rotary	41	Cello		71	Ocarina	
12	Percussive Organ		**Rotary	42	Tremolo Strings		72	Synth.Sawtooth	o
13	Electric PF			43	Harp		73	Synth. Charang	
14	Honky Tonk PF			44	Strings		74	Synth.Voice	
15	Pan EP1	o		45	Slow Strings		75	Synth.Bass&	
16	Clavinet	o		46	Horn & Strings		76	Synth. Warm	
17	Celesta	o		47	Synth. Strings		77	Synth. PolySynth	
18	Glocken	o		48	Choir		78	Synth. Choir	
19	Music Box	o		49	Dooh		79	Synth. Bowed	
20	Vibraphone	o		50	SynVOX		80	Synth. Halo	
21	Santur	o		51	Trumpet		81	Crystal	
22	Drawbar Organ 1		**Rotary	52	Trombone		82	Atmosphere	
23	Drawbar Organ 2		**Rotary	53	Tuba		83	Brightness	
24	Rock Organ		**Rotary	54	French Horn	o	84	Echo Drops	
25	Small Church Organ			55	Brass w/ Trumpet	o	85	Sitar	
26	Reed Organ			56	Synth. Brass 1	o	86	Koto	
27	French Accordion	o		57	Synth. Brass 2	o	87	Bagpipe	
28	Harmonica	o		58	Synth. Brass 3		88	Tinkle	
29	Bandoneon	o		59	Synth. Brass 4				
30	Nylon Guitar	o		60	Soprano Sax				

The shaded instruments in the chart are those which can also be selected with the “TONE” button.

All instruments have an individual Reverb level.

* Slow Strings will play within velocity 1-99.

** The speed of rotary speaker effect can be changed by pressing the **RIGHT** pedal.

Effect Settings (Not available on ProScan)

QuietTime has four kinds of built-in sound effects which can be customized. These effects are called Reverb, Chorus/Rotary, Delay, and Transpose. The following pages describe how to access and adjust these effects. The settings for transpose remain active when the instrument is changed.

The settings for other sound effects are reset to factory defaults when the tone is changed. The settings for all sound effects are reset to factory defaults when the power is switched off and back on. The effects are available for most tones, but not for all.

NOTE: The iOS app provides a more convenient method for controlling the effects. (See chapter 6)

Reverb

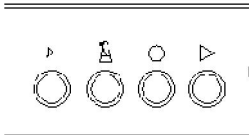

Tone and  – Press and hold the “TONE”- and the “METRONOME”-buttons.



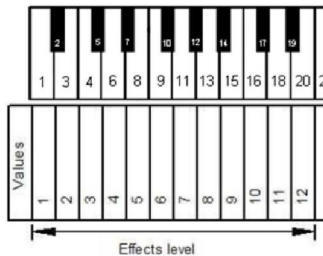

Piano key

- Play piano key #28 (C3) to select the reverb sounding like you are playing in a room or
- Piano key #30 (D3) to select the reverb sounding like you are playing in a hall.
- Play piano key #32 (E3) to deactivate the reverb effect.



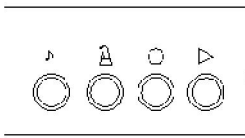

Piano key – Play a white piano key between 1 & 20 (A0 – E1) to select the level (intensity) of the reverb effect.

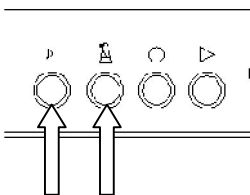

Tone and  – Release the “TONE”- and the “METRONOME”- buttons to save your settings.

Chorus/Rotary Speaker



Tone and  – Press and hold the “TONE”- and the “METRONOME”-button.

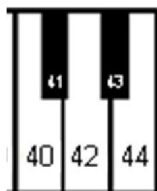

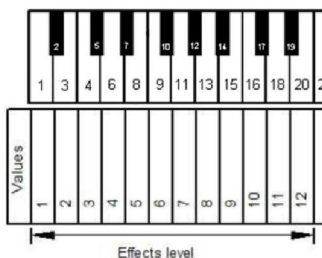

Piano key

- Play piano key #40 (C4) to activate the Chorus effect OR
- Play piano key #42 (D4) to activate the rotary speaker effect.
- Play piano key #44 (E4) to deactivate the effects.

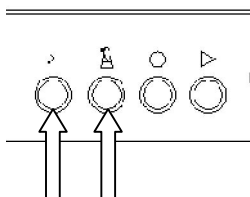

Piano key – Play a white piano key between 1 & 20 (A0 – E1) to select the level (intensity) of the Chorus effect.



Tone and  – Release the “TONE”- and the “METRONOME”-button to save your settings.

Note:

The rotary speaker effect changes the function of the pedals!
 Right pedal switches between slow and fast rotary speaker effect. Left pedal is used to switch the rotary speaker effect to standby. Pressing the pedal again re-activates the rotary effect. To fully deactivate the rotary effect and normal pedal operation you need to switch the effect off completely by using the steps described above.

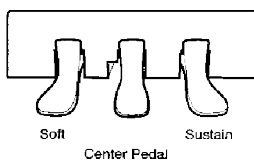

Delay

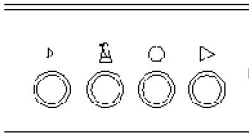

Tone and  – Press and hold the “TONE”- and the “METRONOME”-buttons.

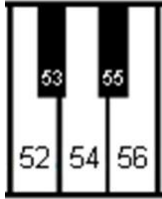

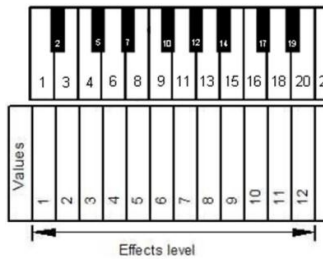

Piano key

- Play piano key #52 (C5) to activate the delay effect or
- Play piano key #54 (D5) to deactivate the delay effect.

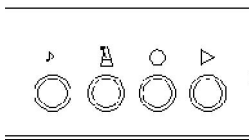

Piano key – Play a white piano key Between 1 & 20 (A0 – E1) to select the amount of delay for the Chorus effect.



Tone and  – Release the “TONE”- and “METRONOME”- buttons to save your settings.

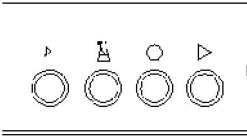

Transpose

Tone and  – Press and hold the “TONE”- and the “METRONOME”-button.

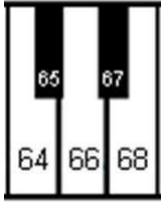

Piano key

- Play piano key #64 (C6) to transpose the piano's pitch down by $\frac{1}{2}$ steps,
- Play piano key #68 (E6) to transpose the pianos pitch upwards by $\frac{1}{2}$ steps.
- Play piano key #66 (D6) to reset the piano's pitch to normal.

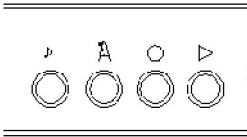

Tone and  – Release the “TONE”- and “METRONOME”- buttons to save your settings.

Note:

The settings for transpose remain active when the instrument is changed.

The transpose effect resets to factory defaults when the power is switched off and back on.

If ProRecord is being used with a PianoDisc iQ system connected through the “EXT” jack, the transpose feature can be set to also transpose iQ playback. This can be set using the ProRecord App on an IOS device (See Chapter 6). In the “Adjustments” menu, set “CONNECT WITH IQ PLAYER” to “ON”.

Reset All Effects

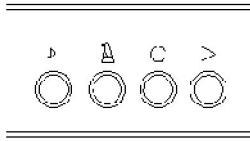

Tone and  – Press and hold the “TONE”- and the “METRONOME”-button.

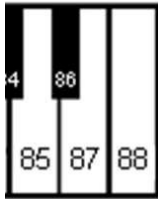

Piano key – Play piano key #88 (C8) to reset all effects and transpose to factory defaults.

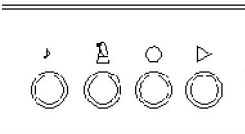

Tone and  – Release the “TONE”- and the “METRONOME”-button to save your settings.

Bass End of Keyboard

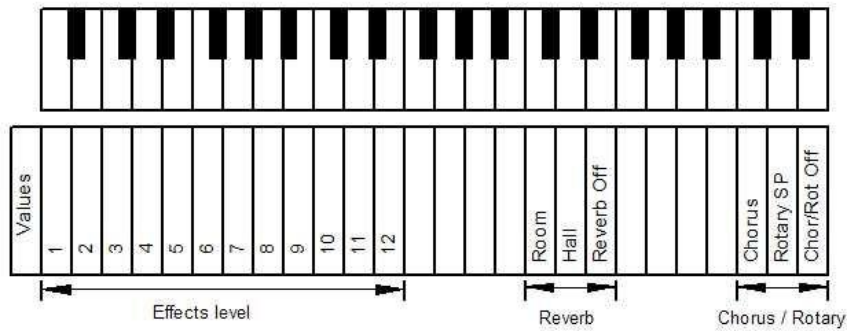

Treble End of Keyboard

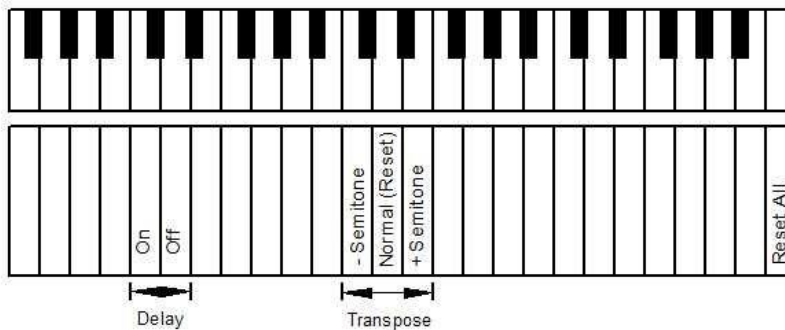

Metronome (Not available on ProScan)

QuietTime has a built-in metronome function which can be setup with various parameters, such as beat, tempo, and volume. Although the features can be controlled with the control box and the piano keys, The IOS app provides a much more convenient method (see Chapter 6).

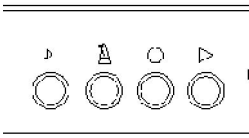

Metronome ON/OFF

 - Press the metronome button to start the metronome. The metronome lamp will turn on and you will hear the metronome beating. Also, the "TONE" LED will flash at the set tempo of the metronome.

Press the metronome button again to stop the metronome

Metronome Setup

 - Press and hold the metronome button for about two seconds.

The metronome lamp flash is indicating that you are in the setup mode. The metronome will also begin to sound.

See next page.

Beat - Piano keys are used to choose the beat. (refer to the figure on the next page). The metronome can be set up with the following beat patterns: 0, 2, 3, 4, 5, 6, and 8 (Default is 4). Use the piano keys indicated to select the desired beat pattern. E.g. for a 3 beat pattern, press key #32 (E3)

See next page.

Tempo - Refer to the figure on the next page. To set the tempo, enter the desired tempo using the lowest 10 white keys on the piano. It is necessary to enter the tempo as a 3 digit number, so tempos less than 100 need to be preceded by a "0" e.g. for 60, enter "060" or keys #16,9,16 (C2,F1,C2) The allowable tempo range is 030 to 250.

See next page.

Volume - Use white keys #81-88 (Refer to the figure on the next page).

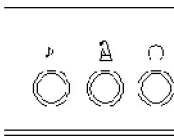

 - Exit setup mode by pressing the metronome button. The metronome lamp changes from flash to solid. The metronome will continue to sound until the metronome button is pressed again.

NOTES:

The metronome settings are saved when power is turned off.
The IOS app can also be used for controlling the metronome.

Piano keys needed for metronome setup

Bass End of keyboard

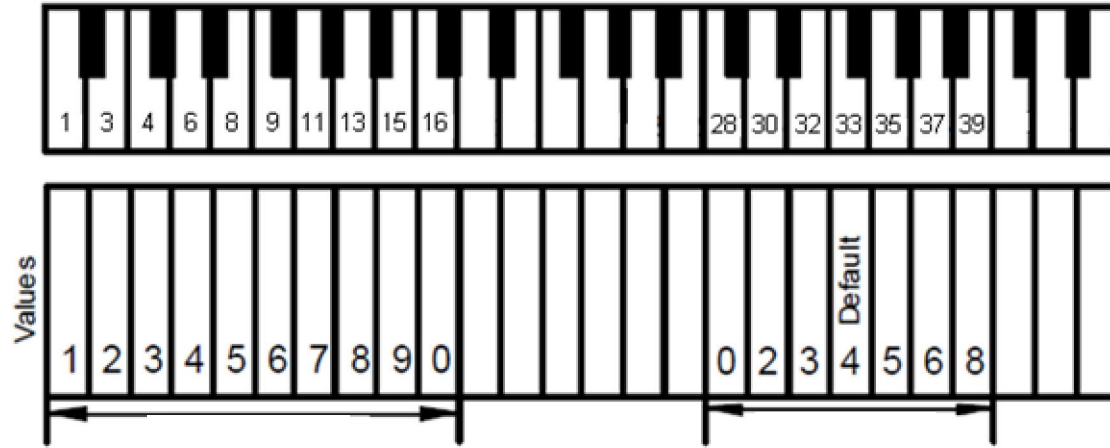

Treble End of keyboard

Volume

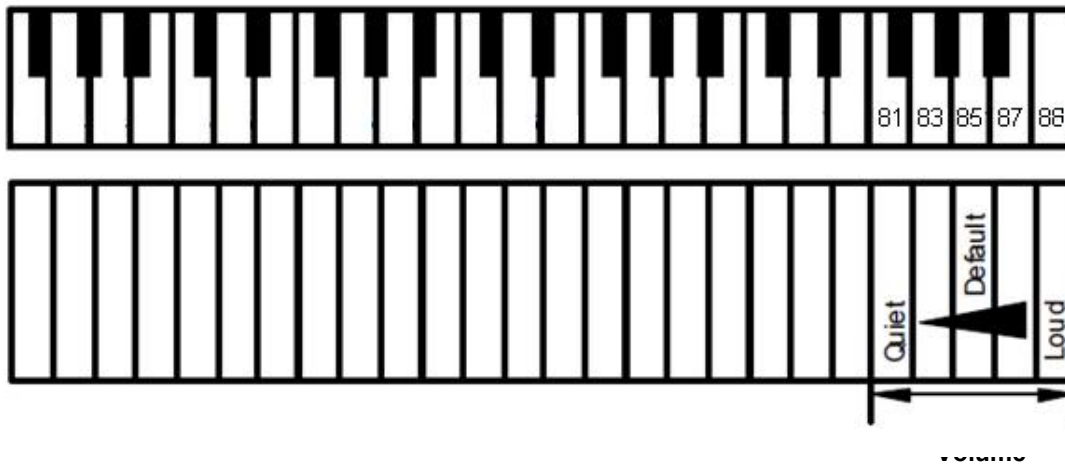

Recording and Playback

QuietTime can record your piano performance and play it back at a later time. There are 10 banks that act as memory storage for the recorded song. The figure on the next page shows which piano keys are used to access the storage banks.

NOTE: The iOS app provides a more convenient method for controlling record & playback.

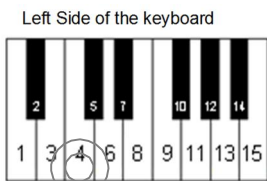

+

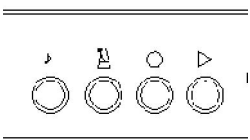
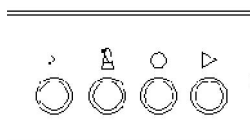

Record Instructions

Piano key - Press and hold the piano key for the bank you wish to record to. (Use one of the first 10 white keys)

RECORD- Then press the “RECORD” button.

The “REC” lamp will light up to indicate that you are in the record mode.

Note: If you do not select a bank to record to, bank 1 will be selected by default.

- Recording will start when you play the first note or press a pedal.

REC – Stop recording. When you are finished, press the “REC” button. The “REC” lamp will turn off and data will be saved in the selected bank.

NOTE

- Recording to a bank that already has data will cause the previously stored data to be overwritten.
- Any instrument can be setup to record. However it cannot be changed during the recording.
- The metronome can be used during recording but the sound is not recorded.
- Each bank can store about 10, 000 key or pedal strokes. Once this limit is reached, recording will be stopped automatically.
- The recorded data is saved when power is turned off.

Delete a Recorded Song

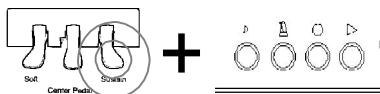

Sustain Pedal + REC - Press and hold the sustain pedal, then press and hold the “REC” button.

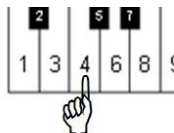

Piano key - Press the piano key for the bank you wish to delete (see the figure on the next page). A chime will sound confirming that the data has been deleted. Performing a System Default (see Chapter 5,) deletes any data stored in all 10 banks.

Playback Instructions

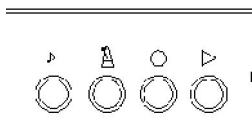

PLAY - Press the “PLAY” button.

The “PLAY” lamp turns on to confirm that QuietTime is in play mode. The recorded song in bank 1 will begin to play about 1 second later.

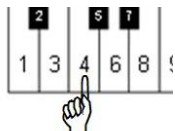

Piano key - T- select a different bank, press the piano key for the bank desired. (One of the first 10 white keys)

NOTE:

You can also play the piano along with the recorded playback.

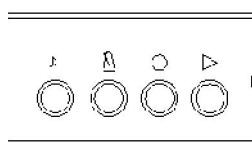

PLAY - To stop the playback, press the “PLAY” button. The “PLAY” lamp will turn off and playback stops.

NOTES

- The first 10 white keys of the piano are assigned to bank selection during playback. Therefore they will not sound if you play along with the recorded playback. If they are pressed during playback, a different bank will be selected for playback. Likewise, the last three white keys of the piano are assigned to tempo change functions during playback and will not sound.
- Playback will not start if there is no data in bank 1. If there is data in any of the other banks, press and hold the bank you want to play, and then press the “PLAY” button.
- When ProRecord is used with a PianDisc iQ system and “CONNECT WITH IQ PLAYER” is turned on, the “RECORD” bank keys and TEMPO keys on the piano are disabled.

Changing the playback tempo of a recorded song

The playback tempo of a recorded song can be changed during playback. The range of adjustment is from 50% to 200% of the normal tempo.

Tempo Instructions

See
Playback Instructions

Select a bank that has recorded data and play it back as described above.

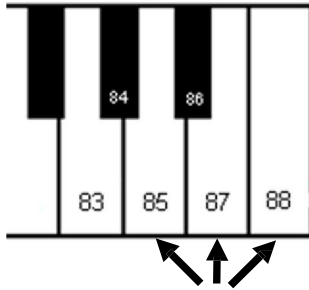

Piano key - Press one of the piano keys that control tempo (Refer to the following figure.)

- Key #85 (G7) decreases the tempo. (5 steps)
- Key #88 (C8) increases the tempo. (5 steps)
- Key #87 (B7) returns the tempo to normal.

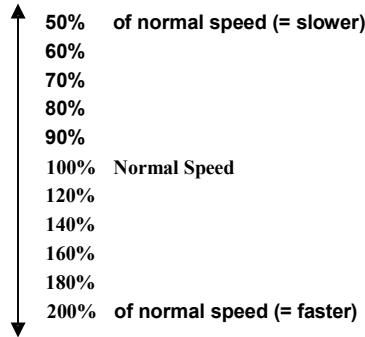

Treble End of Keyboard

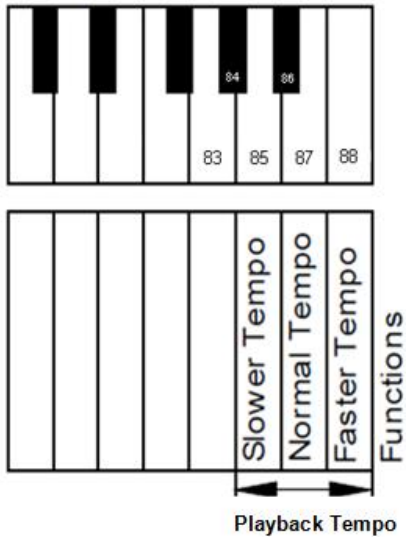

Chapter 5 – Adjustments and Configurations

NOTE: The IOS App makes all adjustments and configurations easier (see chapter 6)

Note Repeat Limit

ProRecord can be set up with limits to how many times a note can be repeated per second.

Setup Instructions

Bass end of keyboard

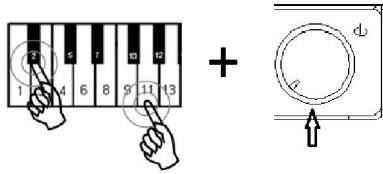

Piano keys 2 and 11 + Power ON - Press and hold Keys #2 and 11 (A#0 & G1) while turning the power on (refer to the figure below).

If a MIDI device is connected, a MIDI signal will sound confirming that the system is in setup mode.

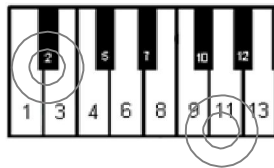

Piano keys 2 and 11 - Continue holding the two piano keys.

Piano key 16, 18, 39, 40 - Select the repeat limit desired from the keyboard (see figure below).

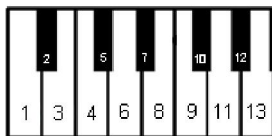

Release the two piano keys to store your setting and to exit setup mode.

Caution!

Choosing a re-strike limit that exceeds the piano capability may cause undesirable effects.

Bass end of keyboard

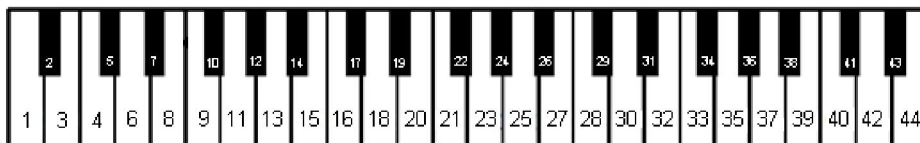

5	6	7	8	9	10	11	12	13	14	15	16	17	18 (Default)	No Limit
---	---	---	---	---	----	----	----	----	----	----	----	----	--------------	----------

Tuning (Adjusting the pitch) (Not available on ProScan)

The Pitch of this instrument is set at A4 = 440 Hz. You can fine-tune the pitch up or down in 0.5 Hz steps. The maximum adjustment either direction is 13 Hz.

Tuning Instructions

Bass end of keyboard

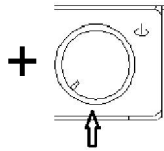

Piano keys 2 and 5 + Power ON - Press and hold keys #2 (A#0) and 5 (F#1) while turning the power on. A chime will sound confirming that you are in setup mode.

Piano keys 2 and 5 - Continue holding the two keys.

+

Piano key 47 - To lower the pitch, press key #47 (A4) repeatedly until the desired pitch is established. Key #47 lowers pitch by about -0.5 Hz per step (maximum of -13 Hz).

Piano key 51 - To raise the pitch, press key #51 (B4) repeatedly until the desired pitch is established. Key 51 raises pitch by about +0.5 Hz per step (maximum of +13 Hz).

Piano key 40 - To return to A.440, press key #40 (C4).



Piano Keys 2 and 5 - Release the two keys 2 and 5 to save your setting and exit setup.

Note:

In some pianos the tuning effect may not be available.

Setting will be retained when the unit is powered off.

Touch Control (Adjusting the touch)

ProRecord has the capability of changing the touch of the keyboard (lighter or heavier). While it does not actually change the touch of the piano action, it can give the impression that the action is lighter or heavier. The idea is to match the feel of your acoustic piano. A heavier action would use a setting of 1 or 2 and a lighter action would be set to 7 or 8. The factory default for Touch Control is 4, this is applies e.g. to a Yamaha U3.

Touch Control Instructions

Bass end of keyboard

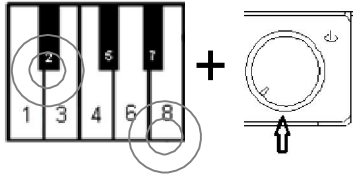

Piano keys 2 and 8 + Power ON - Press and hold down keys #2 and 8 (A#0 & E1) while turning the power on. You will hear a MIDI signal that confirms that the system is in the setup mode.

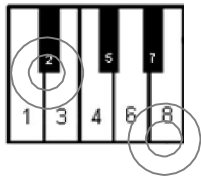

Piano keys 2 and 8 - Continue holding the two keys.

+

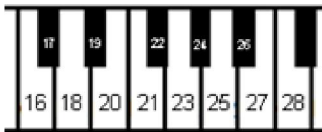

Piano a white key #16 - 28 (C2 – C3) - Select the desired touch control setting by playing the matching piano key. (Refer to the figure below). Here are some typical settings:

YAMAHA : 3 ~ 5

KAWAI : 2 ~ 3

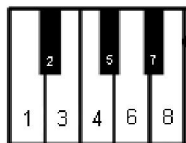

Piano keys 2 and 8 - Release the two keys to store your setting and to exit setup. The setting is retained when the power is turned off.

Bass end of keyboard



Heavy				Default				Light
1	2	3	4	5	6	7	8	
Touch Control Settings								

Pedal On position

ProRecord allows you to set the depth at which the pedal function turns on. You can also enable a proportional pedal function for the sustain pedal if desired.

Pedal ON Position

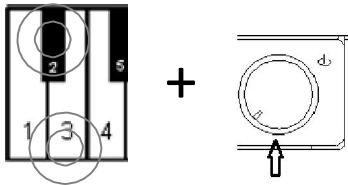

Piano keys 2 and 3 + Power ON - Press and hold key 2 and 3 (A#0 & B0) while turning the power on. A chime will sound to confirm that you are in pedal setup mode.

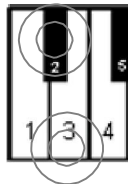

Piano keys 2 and 3 - Continue holding the two piano keys.

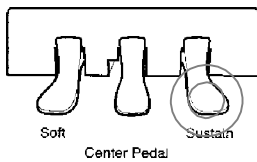

Piano Pedal Left, Center or Right - Press the pedal you wish to set to the depth which you want it to turn on. Hold the pedal at this position.

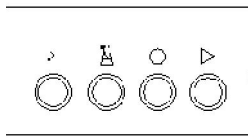

PLAY - Press the "PLAY" button. A chime will sound indicating that the pedal "ON" position has been set.



Piano keys 2 and 3 - Release the two piano keys.

Pedal Resolution (Enable/disable proportional pedal)

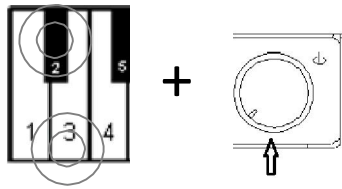

Piano keys 2 and 3 + Power ON - Press and hold key #2 and 3 (A#0 & B0) while turning the power on. A chime will sound to confirm that you are in pedal setup mode.

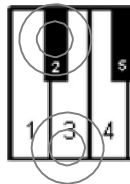

Piano keys 2 and 3 - Continue holding the two piano keys.

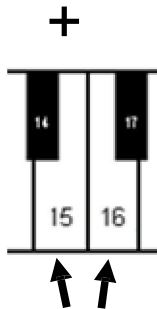

Piano key 15 or 16 - To enable or disable proportional damper pedal.

- Press key #16 (C2) for proportional pedal or
- key #15 (B1) for ON/OFF pedal.



Release the two piano keys to exit setup mode.

Note:

Proportional pedal is not recommended for use with a piano player system.

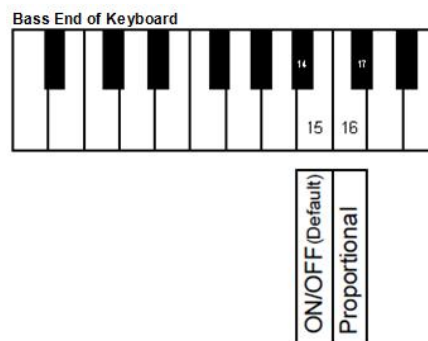

Damper Pedal Function

Key Depth

Key travel instructions

The following instructions describe how to set the range at which the note turns on. There are separate settings for upper key travel and lower key travel.

Bass End of Keyboard

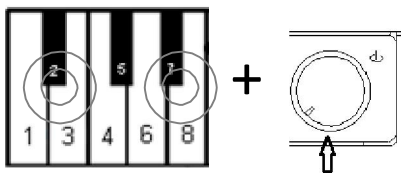

Piano keys 2 and 7 + Power ON - Press and hold keys #2 and 7 (A#0 & D#1) while turning the power on. A MIDI signal will sound confirming that you are in the setup mode.

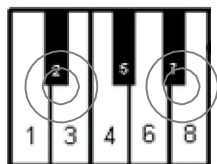

Piano keys 2 and 7 - Continue holding the two keys.

+

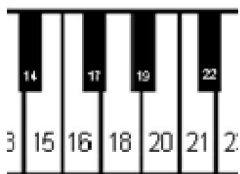

Upper key travel - Piano keys 16, 18, 20 or 21 (C2-F2) -

Select the upper key travel depth desired for the note to turn on. Minus 2 and Minus 1 will cause the note to turn on earlier in the key travel, while plus 1 causes the note to turn on later. (0 is default)

-2 : -1 : 0 : +1

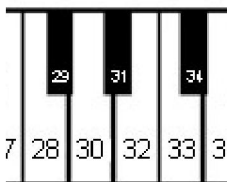

Lower key travel - Piano keys 28, 30, 32, or 33 (C3-F3) -

Select the lower key travel depth desired for the note to turn on. Minus 1 will cause the note to turn on earlier and plus 1 and plus 2 causes the note to turn on later. (0 is default)

-1 : 0 : +1 +2

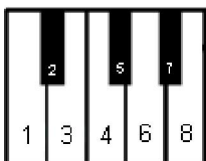

Piano keys 2 and 7 - Release the two keys to save your setting and exit setup.

Continuous note-on instructions

Bass End of Keyboard

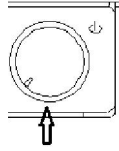
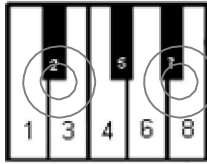

Piano keys 2 and 7 + Power ON - Press and hold keys 2 and 7 (A#0 & D#1) while turning the power on. A MIDI signal will sound confirming that you are in the setup mode.

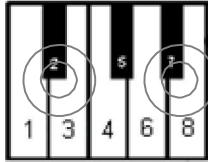

Piano keys 2 and 7 - Continue holding the two keys.

+

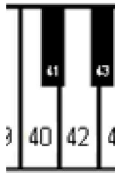

Piano key 40 or 42 (C3 or D3) - Select key # 40 (C3) to Enabled or key #42 (D3) to Disable (Enabled is Default).

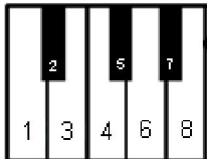

Piano keys 2 and 7 - Release the two keys to save your setting and exit setup.

Black Keys Volume Control

If the volume of the black keys is different than the white keys, they can be adjusted to match.

Black Key Volume instructions

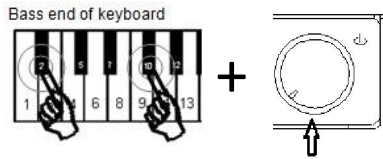

Piano keys 2 and 10 + Power ON - Press and hold keys 2 and 10 (A#0 & F#1) while turning the power on. A chime will sound confirming that you are in the setup mode.

Bass end of keyboard

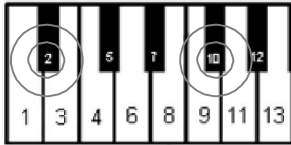

Piano keys 2 and 10 - Continue holding the two keys.

+



Piano key 16, 18, ... 32 or 33 – Use white keys between notes 16 and 33 (C2 to F3) to select the volume level that best matches the white key volume. (Refer to the figure below.)

Bass end of Keyboard

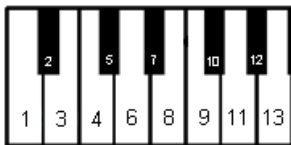

Piano keys 2 and 10 - Release the two keys to save your setting and exit setup mode.

Bass end keyboard

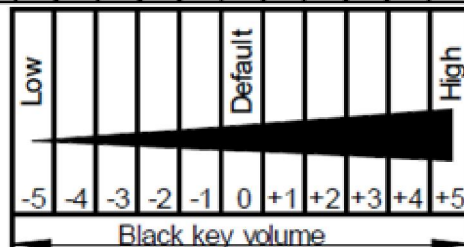
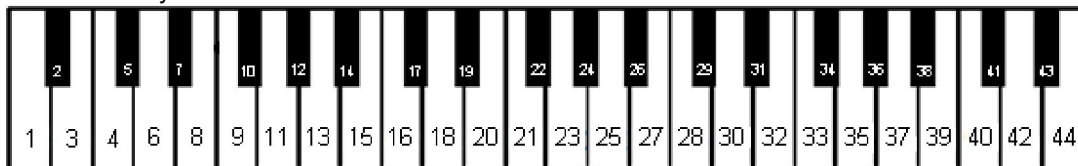

Volume Control for individual keys (Bass keys)

The volume level for individual keys can be adjusted in order to get even volume from note to note. The lower half of the keyboard must be done separately from the upper half. The range of the adjustment is from -5 to +5. (default is ± 0)

Volume Setting Instructions

Treble end of keyboard

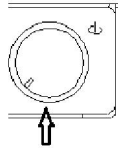
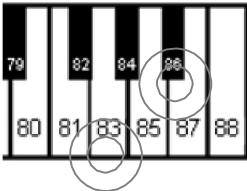

- 1. Piano keys 83 and 86 + Power ON** -To increase volume, press and hold keys 83 (G7) and 86 (A#7) while turning the power on. A chime will sound to confirm that you are in the setup mode.

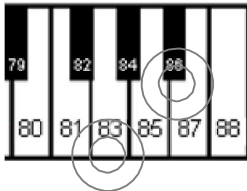

- 2. Piano keys** - Continue holding the two keys.

Bass end of keyboard

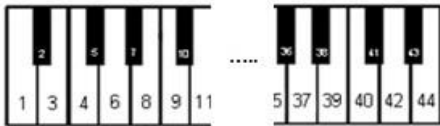

- 3. Piano key 1 - 44 .** - Select the note that needs to be adjusted from the lower half of the keyboard (key 1 through 44) and press the key repeatedly until the desired volume is reached. Adjust other notes as needed.

Treble end of keyboard

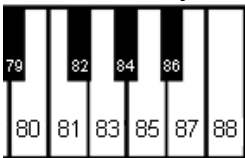

- 4. Piano keys** - Release the two keys to save the setting and exit setup mode.

Treble end of keyboard

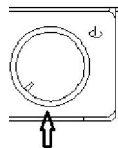
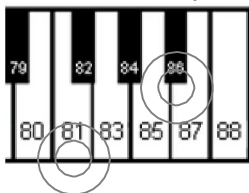

- Piano keys 81 and 86 + Power On** - To decrease volume, press and hold 81(F7) and 86 (A#7) while turning on the power. Then do steps (2), (3) and (4) as described above.

Volume Control for individual key (Treble keys)

Volume Control for individual key (Treble keys)

Volume adjustment for individual keys in the upper half of the keyboard (45 through 88) is done in the same way as the lower half except that the setup keys are different. In addition, there is a reset key which returns all values to the default setting of "0".

Volume Setting Instructions

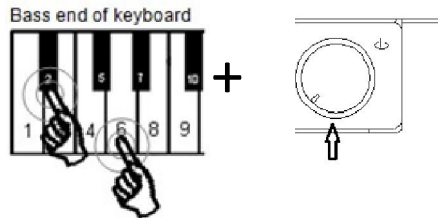

1. **Piano keys 2 and 6 + Power ON** - To increase volume, press and hold keys 2 (A#0) and 6 (D1) while turning the power on. A chime will sound to confirm that you are in the setup mode.

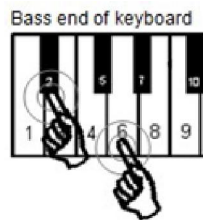

2. **Piano keys** - Continue holding the two keys

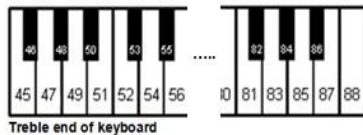

3. **Piano keys 45 - 88** - Select the note that needs to be adjusted from the upper half of the keyboard (key 45 through 88) and press the key repeatedly until the desired volume is reached. Adjust other notes as needed.

4. **Piano keys** - Release the two keys to save the setting and exit setup mode.

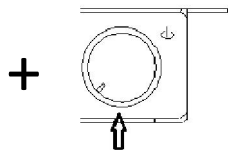

- Piano keys 2 and 4 + Power ON** - To decrease volume, press and hold 2 (A#0) and 4 (C1) while turning on the power. Then do steps (2), (3), and (4) as described above.

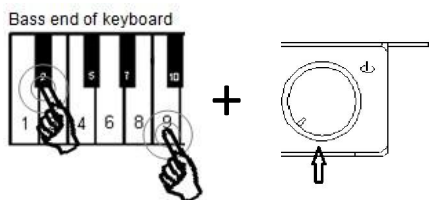

- Piano keys 2 and 9 + Power ON** - To reset all values to "0", press and hold keys 2 (A#0) and 9 (F1) while turning on the power. Then do step (4) as described above.

Reset to factory defaults

Caution!

When this process is performed, ProRecord will cease to operate normally. An initial setup is required in order to continue using. The initial setup procedure is outlined on the next page. The following charts show the default settings:

Default Configuration

Recorded songs : All Deleted
Number of Re-strikes Per Second : 18
Initial Setting : Clear Sensor
Calibration : Clear
Sensor Automatic Calibration : ON
Touch Control : 4
Pedal Positioning : Clear
Damper pedal function : Proportional
Adjusting the Depth to Sound : 0
Continuous note-on MIDI commands : Enabled
Black Keys Volume Control : 0
Volume Control for Each Key : All 88 keys = "0"

Reset to Factory Defaults

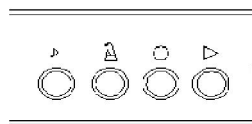
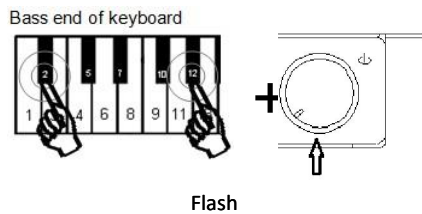

Piano keys 2 and 12 + Power ON -. Press and hold keys 2 (A#0) and 11 (G#1) while turning the power on (see figure below.) A MIDI signal will sound and the "PLAY" and "REC" LEDs will flash alternately.

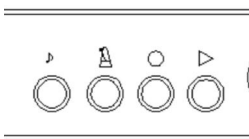
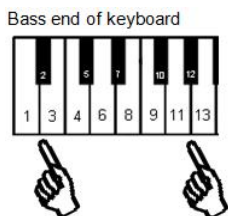

Piano keys 2 and 11 - Release the two keys.

The "PLAY" and "REC" lamps will stop flashing and the system has been reset to default values.

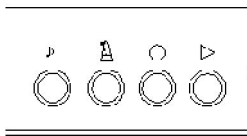
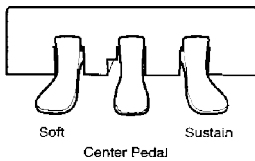
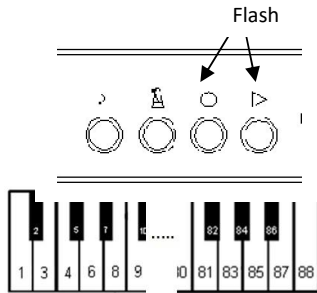
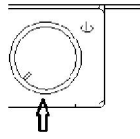

Initial Setup Instructions

1. **Power On** - Turn the power on.
2. A chime will be heard and the “PLAY” and “REC” lamps will flash alternately indicating that the system is in “Initial Setup Mode”.
3. **Piano keys 1 to 88** - Play each note of the keyboard with equal force, making sure each key goes to full depth. When each note is released, the note will sound slightly delayed indicating that each key was calibrated.
4. **Left, center and right pedal** - Press each pedal with equal force and full depth. A chime will sound after each pedal is press indicating that the pedal was calibrated. The chime for each pedal will be a different pitch.
5. **PLAY** - Push the “PLAY” button. If the calibration of all keys and pedals was successful, a chime will be heard and the “PLAY” and “REC” lamps will stop flashing.

Notes:

- It may be helpful to pause a moment between each note to ensure that the note calibrates properly.
- The Initial setup procedure will reset the touch control setting. Therefore, you must repeat the procedures outlined for touch control to restore to your desired setting.

Sensor Re-calibration

The sensitivity of the keyboard and pedal sensors can change with time and/or temperature. Periodic adjustments are required to keep your system operating at its optimum performance.

Re-Calibration Instructions

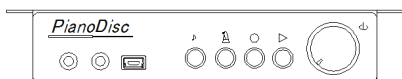

PLAY and REC + Power ON -Press and hold the "PLAY" and "REC" while turning the power on.

Flash

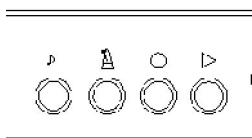

A chime will be heard and the "PLAY" and "REC" lamps will flash alternately indicating that the system is in "Initial Setup Mode".

Notes:

- If the system is powered off before the "PLAY" button is pressed, the calibration procedure will not be completed and must be done again.
- It may be helpful to pause a moment between each note to ensure that the note calibrates properly.

Automatic sensor calibration

ProRecord has the capability of calibrating the key and pedal sensors automatically. This function is enabled by default but can be disabled if desired.

Disable Automatic Sensor Calibration

Bass end of keyboard

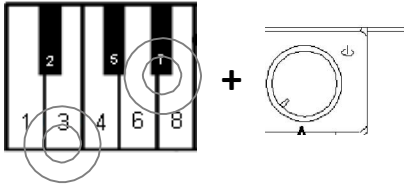

Piano keys 3 and 7 + Power ON - Press and hold keys 3 (B0) and 7 (D # 1) while turning the power on. A MIDI signal will sound indicating that the automatic sensor calibration function has been disabled.

Enable Automatic Sensor Calibration

Bass end of keyboard

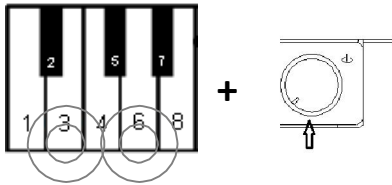

Piano keys 3 and 6 + Power On - Press and hold keys 3(B0) and 6(D1) while turning the power on. A MIDI signal will sound indicating that the automatic sensor calibration function has been enabled.

Chapter 6 –

USING THE iOS APP



The iOS app (for iPhone, iPad, or iPod touch) provides a much easier method for controlling the functions of Quietime ProRecord system. To use it, your device must have IOS 7.1 or higher. Download the free app from the Apple Store and install it on your device.

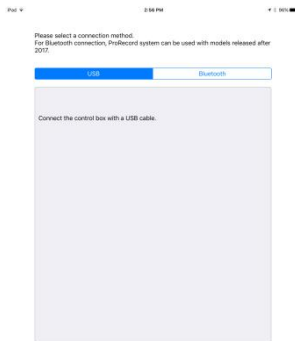

Power on the ProRecord by pushing the volume button. Open the app and choose a connection method. There are two methods of connecting; USB or Bluetooth. (see picture on left)

If you plan to use a USB cable to connect, select “USB”. You will need an adapter (available from Apple or other retailers) to connect to a USB cable. Connect the cable (included) to the USB mini jack on the front of the control box.

If you plan to use a Bluetooth connection, select “Bluetooth”. The app will display a list of Bluetooth MIDI devices. Select “PD ProRecord” and wait until the status says “Connected” (Be sure Bluetooth on your device is turned on).

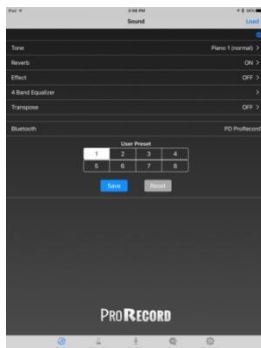

Once the device has connected, the “Sound” screen will be displayed (see picture on left). This screen controls the Tone (or instrument selection), Reverb, Effects, Equalizer, and Transpose. It also indicates whether you are connected to Bluetooth MIDI and allows you to change from a USB connection to Bluetooth MIDI. There is a User Preset area that allows you to save your settings for up to 8 different users.

The “Metronome” screen (see picture on left) controls the metronome function of the ProRecord.

The 1st item selects the beat pattern (or beats per measure). Touch the pattern desired.

Next is the tempo control which is set by touching the left (<) or right (>) arrows. This display flashes at the set tempo.

The Green arrow turns the metronome on & off (changes to a square when turned on)

The last item controls the volume of the metronome clicks.

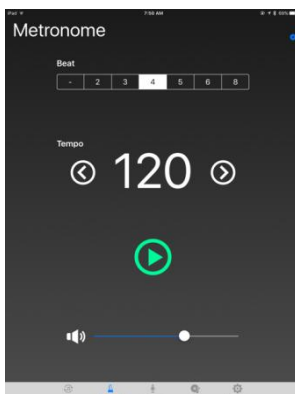

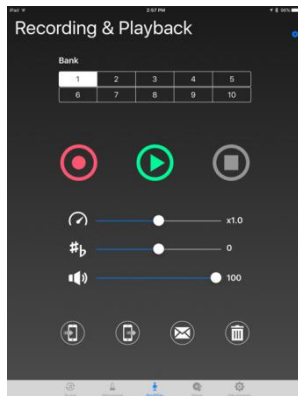

The next screen (left) controls Recording & Playback.

The 1st item selects the memory bank that you will record to or play from.

The Red circle starts a recording. The green arrow plays back a recorded song. The grey square stops record and playback.

The next three items control the playback tempo, transposition and volume.

The Icons at the bottom of the screen allow you to import a song, export a song, email a song, and delete songs (from a selected memory bank).

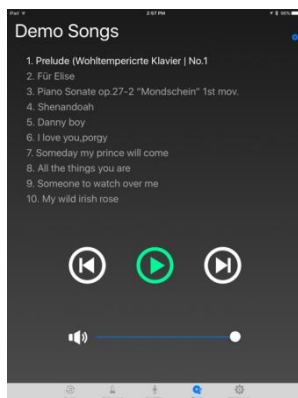

This next screen (left) controls the pre-recorded Demo Songs.

Touch the song you want to play then touch the green arrow. The green arrow changes to a white square. If you touch the green arrow without selecting a song first, it will start with the first song and play each song in order. If one of the white arrows (< & >) is touched during playback, the previous or the next song on the list will start playing immediately. To stop the playback, touch the white square.

The last item controls the playback volume.



The last screen (left) is the “Adjustments” screen. This allows you to change the settings of the ProRecord to suit your desires. Most of these features were explained earlier, but there are a few features that can only be changed with the app.

* Connect with iQ Player. Set this to “ON” if the system is connected to a PianoDisc iQ Player system.

*MIDI-IN Port. Selects the type MIDI In port desired.

*Panel LED. Controls the brightness of the LEDs on the control box.

*Tuning Curve. When enabled, it allows you to tune individual notes of the ProRecord.

Appendix: Technical Information

About MIDI

MIDI is an abbreviated name of Musical Instrument Digital Interface. The performance information on a musical instrument, the change information on a tone, etc. can be transmitted. It is a common protocol in the world.

MIDI (Connecting to Other Device)

ProRecord can be connected to a personal computer, MIDI device or IOS device (iPhone or iPad) using either a USB cable, a MIDI interface cable or via Bluetooth MIDI.

Connection to a personal computer

If a personal computer is connected to your ProRecord, the information is transmitted to the computer as MIDI data. The MIDI data can then be edited and saved on the computer's hard drive or other storage device.

Connection to a MIDI device

If a MIDI device is connected to your ProRecord, the information coming from ProRecord is transmitted to the MIDI device as MIDI data. The MIDI data can then be used by the MIDI device.

MIDI channel Specifications

ProRecord outputs data from the keyboard to the MIDI channel 1. Playback of the recorded data is output to the MIDI channel 2. MIDI channels 3 and 4 are also used for pedal functions.

Example of connection with a personal computer

Connect a personal computer with the USB mini B jack of the control box.
Once the connection is established your computer will install MIDI drivers automatically.
(Compliant OS: WindowsXP, WindowsVISTA, Windows7, Windows 10)

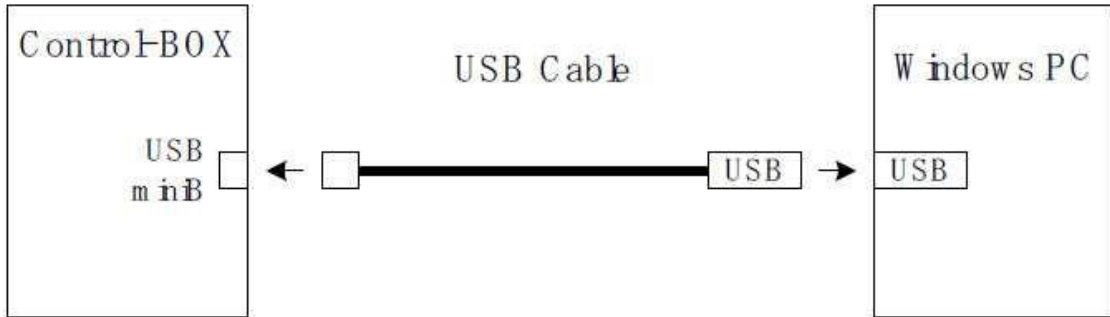

Example of connection with a MIDI device

Connect a MIDI device with the MIDI jack of the control box.

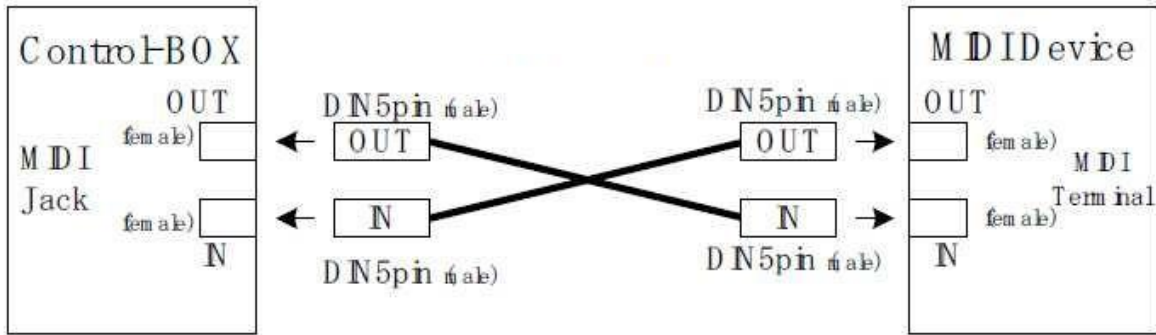

Note:

MIDI and USB cables cannot be used simultaneously.

MIDI Implementation Chart

Function		Transmitted	Recognized	Remarks
Basic Channel	Default	1	1-16	
	Changed	x	1-16	
Mode	Default	3	3	
	Messages	x	x	
	Altered	*****	x	
Note Number		21 – 108	0-127	
	: Range	*****	0-127	
Velocity	Note ON	o	o	
	Note OFF	o	o	
After Touch	Keys	x	x	
	Channels	x	o	
Pitch Bend		x	o	
Control Change	64	o	o	
	66	o	o	
	67	o	o	
	00		o	
	01		o	
	05		o	
	06		o	
	07		o	
	10		o	
	11		o	
	65		o	
	91		o	
	93		o	
	120		o	
	98, 99		o	
100, 101		o		
Program Change		o	o	
	: True#	*****	0-127	
System Exclusive		o	o	
Common	: Song Position	x	x	
	: Song Select	x	x	
	: Tune	x	x	
System Real Time	: Clock	x	x	
	: Commands	x	x	
Aux	: Local ON/OFF	x	x	
	: All Notes OFF	x	o	
	: Active Sense	x	x	
	: Reset	x	x	
Notes				

Mode1 : OMNI ON、POLY Mode2 : OMNI ON、MONO o: Yes
Mode3 : OMNI OFF、POLY Mode4 : OMNI OFF、MONO x: No

Technical Specifications

Polyphony	128-notes
Instrument List	Main Instruments: Piano, Bright Piano, Mellow Piano, Electric Piano1, FM Electric Piano, Church Organ, Warm Organ, Percussive Organ. User can choose 72 additional instruments via piano keyboard or IOS app.
Effect	Reverb (Room, Hall), Chorus (Rotary), Delay
Metronome	Beat, Off, 2, 3, 4, 5, 6, 8
	Tempo 30 ~ 250
	Volume 5 levels
Record/Playback	Record 10 Banks, Memory Size about 10,000 notes per Bank
	Playback Variable Speed (0,5x ~ 2x)
Tuning	± 13Hz (427 ~ 440 ~ 453Hz), default: 440Hz
Transpose	+/- 2 Octaves
Pedal Positioning	ON/OFF, Proportional (Damper Pedal only)
Number of Repeats Per Second	15 Step
Key Depth Settings for Note-on	4 Step
Touch Control	8 Step
Continuous note-on	Enable / Disable
Black Key Volume	± 5 Step
Individual Key Volume	± 5 Step
Demonstration Songs	10
Terminals: Analog, Digital	Headphones x 2, Line out x 1, MIDI IN/Out x 1, Line in x1
Power supply voltage	DC+9V (AC adaptor or supply from EXT interface)
Accessories	Headphones, Power adapter, USB Cable, Owner's manual (CD)
Optional accessories	USB MIDI Interface cable, Powered Speakers, 2 nd Pair of Headphones
Wireless Connectivity	Bluetooth 4.0LE, BLE-MIDI support
ProRecord IOS App	IOS 7.1 or higher

Troubleshooting

- **The unit turns on but does not play. And the "PLAY" and "REC" lamps are blinking alternately.**
 - ProRecord is in initial setup mode. Complete initial setup.

- **Power does not turn on.**
 - Check to see that the power cord is connected correctly. Insert the AC adaptor firmly into the DC9V socket and AC outlet
 - Check for power at the AC outlet.
 - If the problem persists, contact an authorized repair source.

- **Some notes play louder or softer than others or not at all.**
 - It may be necessary to re-calibrate the system or adjust volume levels. See page 30 to re-calibrate the system. If the black key volume does not match the white keys, see page 25. See pages 26 and 27 to adjust the volume on individual notes.

- **Pedal does not work, or is "stuck".**
 - It may be necessary to re-calibrate the pedal sensors. See page 30. If the problem persists, contact and authorized repair source.

- **The tempo of the metronome can't be set up.**
 - Tempo must be set by inputting a 3 digit number using the piano keyboard. A tempo setting of less than 100 must be preceded by "0". The allowable range is 30 to 250. Tempos less than 30 or more than 250 will not be recognized.

OR

For simpler set up procedure, use the IOS App.

PianoDisc Contact Information

PianoDisc – USA

4111 North Freeway Blvd. Suite1
Sacramento CA 95834 Phone: +1 (916)
567-9999

www.pianodisc.com
techsupport@pianodisc.com

Monday – Friday: 8 a.m. – 5 p.m. (Pacific Time)