

Installation manual water-cooler



1 or multiple water cooled Opticlimates can be connected to 1 water cooler. The water cooler is a super efficient way to recirculate water or a glycol-mix in a closed loop system. The fan(s) and the circulation-pump are the only parts that consume energy. The water cooler makes it possible to prepare water for the Opticlimates at outside temperatures over 40°C.*

Setting up the system starts with a good design of the system. Pump-size, piping diameter and layout are the most important items when designing the system.

The pump:

The circulator pump must supply a pre defined flow at a given pressure. The flow is determined by the energy that must be circulated (KW) and the pressure depends on the pressure-drop of the complete system (Opticlimat(s) + piping + water-cooler) We always calculate the correct pump for your setup. We suggest to place the pump indoor.

The piping:

We suggest to use PE-piping with quick connectors. Prevent knees or other fittings that reduce water-flow. We supply all the fittings for PE piping in the package. Supplying the piping is also possible.

The water cooler:

The stock water coolers come as Industrial heavy duty and Ultra light /compact. The stock versions are all vertical models (roof/floor or wall mount). Both models can also be ordered as a horizontal model (roof /floor mount)

The fittings:

Supplied fittings are for PE piping applications. We supply automatic bleeders, air separators, ball valves, treated fittings depending on your setup.

The Fan/pump control:

Fan and pump control are supplied as an option. The Fan/pump control comes as a set of different parts.

- Temperature sensor for water temperature
- Startsensor (current clamp) to determine if compressor is on or off
- Fan/pump controller (the brain)
- Fan/pump box (connects to fan and pump)

The Fan/pump control makes the system even more efficient. The fan speed of the water cooler is regulated depending on water temperature and the pump will only run when there is a need for cooling. When the system is not in use, the pump will run a pre-defined cycle to prevent freezing in colder climates. In cold climates a 20% or more glycol mix is recommended to prevent freezing.

-Setting up 1 Opticlimate on 1 water-cooler

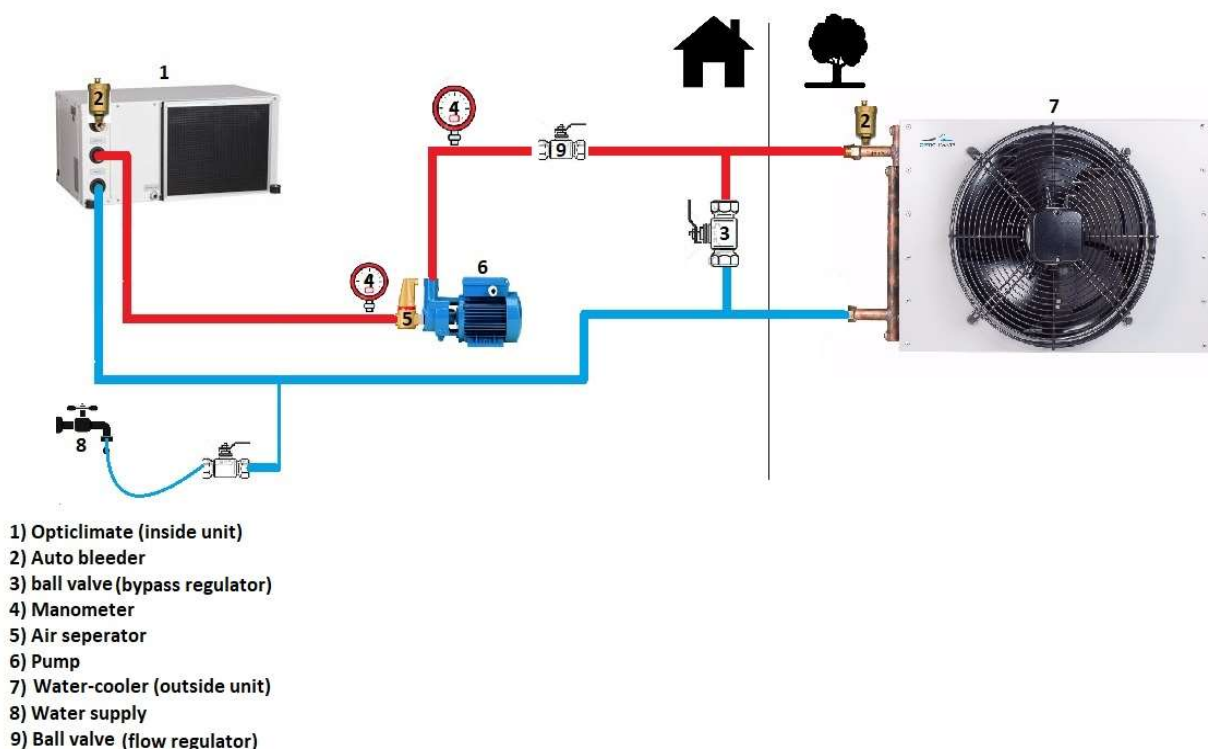

The system is filled with water or glycol mix. The water supply (8) must be located at the lowest point of the system. Automatic bleeders (2) must be located at the highest point of the system. A manometer (4) is positioned on both the return and supply side of the pump. The air separator (5) must be located at a location where the pressure in a running system is the lowest. (pump intake) The set contains 2 ball valves, one to regulate flow (9) and one for the by-pass (3)

Air in the system reduces capacity and can damage pump or heat exchangers. Make sure air is bled from the system after filling. Power the pump for a few seconds to bring air to the highest point in the system. After bleeding, let the pump run full power, the air separator will remove any air bubbles that remain in the system. This can take a few minutes, hours or even days depending on the layout of the piping.

-Setting up multiple Opticlimate on 1 water-cooler

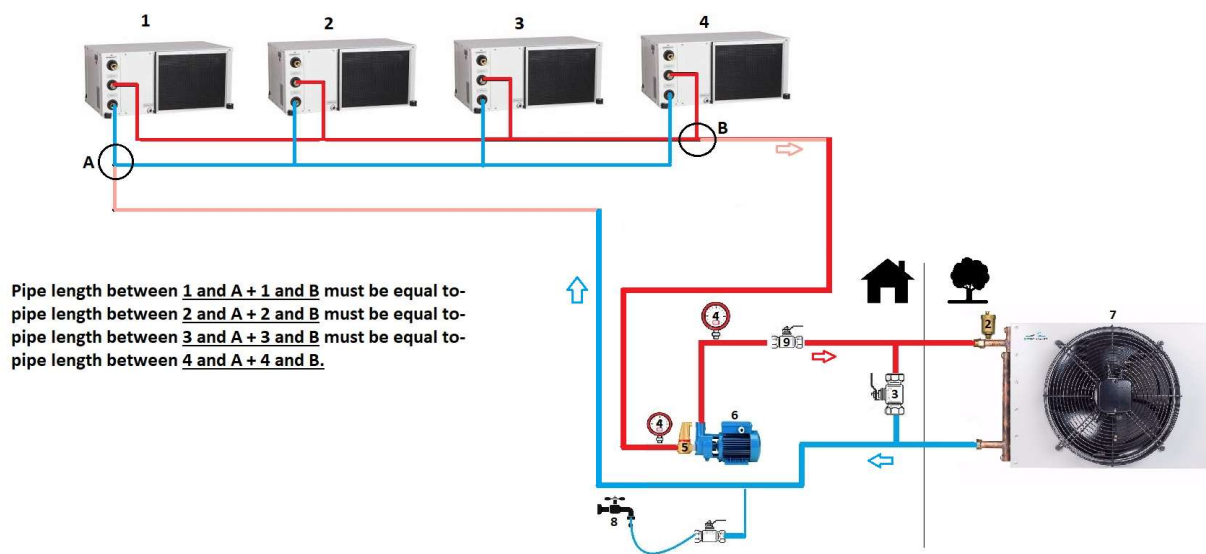

When connecting more than one Opticlimate to 1 water cooler, it's important that pipe resistance (return and supply) for each Opticlimate is the same to prevent uneven water distribution between the Opticlimate.

The setup of the water cooler and pump etc. is the same as described in the chapter Setting up 1 Opticlimate on 1 water-cooler.

The layout of the piping from and to the Opticlimate must be well designed. It's best to consult us using a drawing or sketch of the situation on the Design sheet below.

-Setting up manual Fan/pump control

Tekening

The most simple and cheap way of fan and pump control is to power the pump always and connecting the fan of the water cooler to connection N and 7 inside the electric compartment of the Opticlimate.

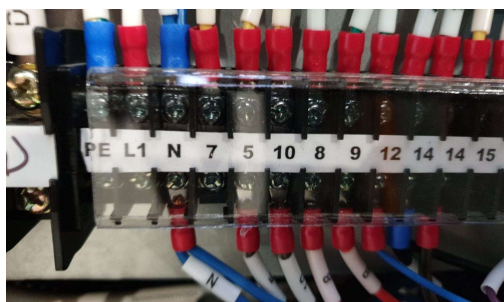

The flow in this setup must be manually adjusted with a valve in the piping between pump and water cooler. The flow needs a periodic adjustment depending on outside temperatures. ΔT between water-in and water-out of the Opticlimate needs to be 5K. More flow lowers ΔT , less flow increases ΔT .

-Setting up fully automatic controlled Fan/pump control

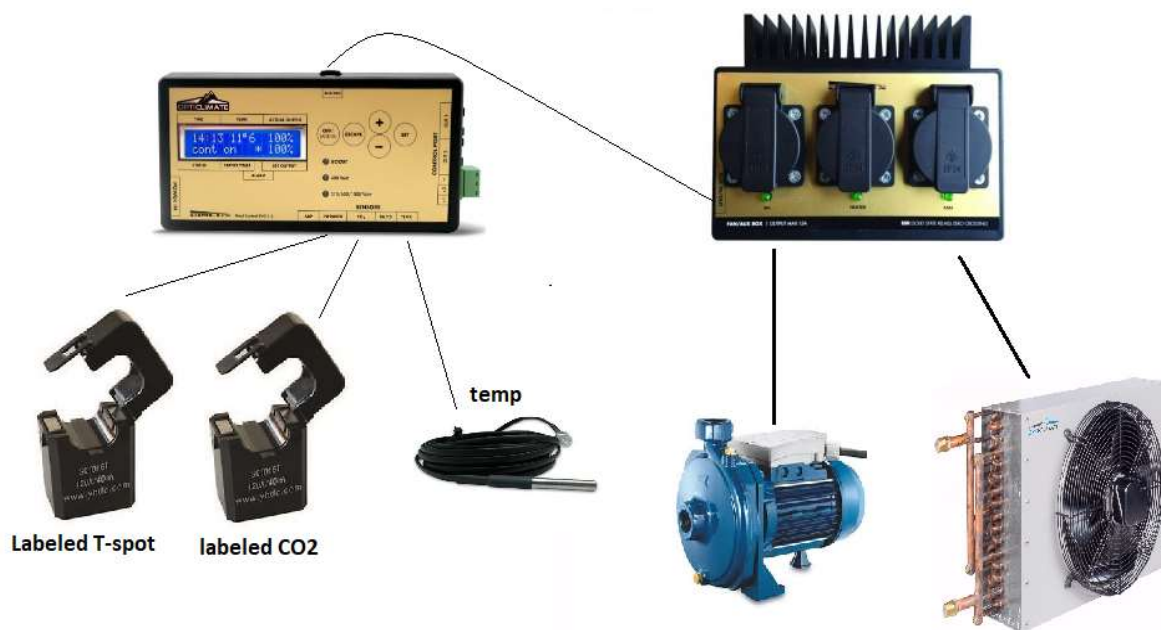

A maxi-controller evo in combination with a fan-aux-box is used to control pump on/off and fanspeed. The controller receives 2 signals from 2 sensors: temperature sensor to determine water temperature in the system and a current transformer to determine if the compressor inside the Opticlimate is on or off.

Connecting the current transformer:

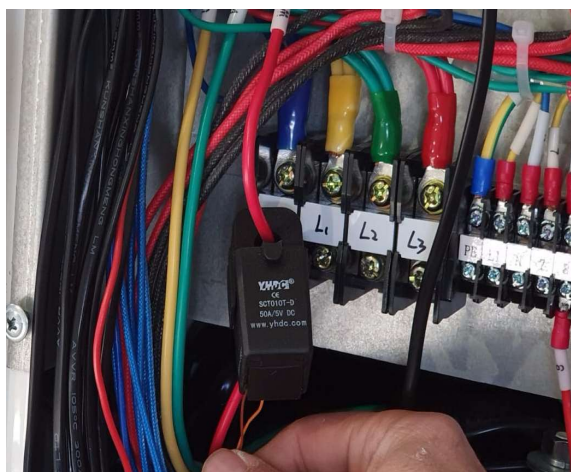

On/off model Opticlimate

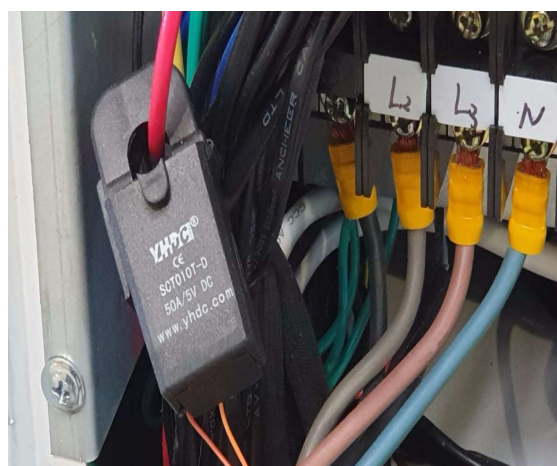

Inverter model Opticlimate

When using an on/off model Opticlimate, find the cable that powers the compressor coming from relays KM1. Cable code U, V or W.

When using an inverter model Opticlimate, find the cable that powers the inverter PCB or compressor. The current clamp can be opened to clamp around the cable. Plug the other end into the controller. The cable is labeled CO2 or T-spot. A current transformer labeled CO2 must be connected to the controller CO2 port. A current transformer labeled T-spot must be connected to the INFRARED port of the controller.

Connecting the water temperature sensor:

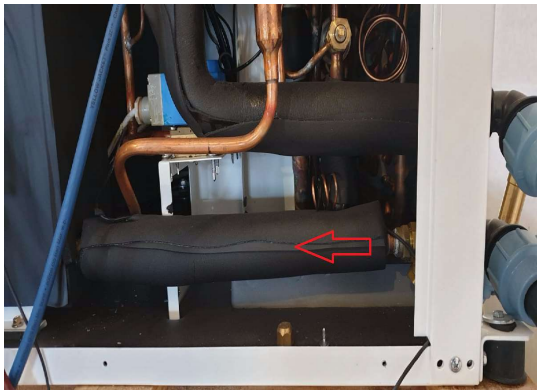

Move isolation back as far as possible



Place sensor on copper pipe



Move the isolation sleeve back to cover the sensor and route the cable to the controller.

Plug the cable into the controller on the TEMP port.

Connecting the fan-aux-box:



Use the supplied communication-cable to connect the controllers AUX connection on top with the fan-aux-box AUX-IN connection on the left side. The power outlet marked FAN on the fan-aux-box must be connected to the fan of the water cooler and the pump must be connected to the outlet marked RH. The settings on the controller are pre-set. Do not change them without consultation. Power both the controller and fan-aux-box. The fan and pump go on for a few seconds, this is normal at first startup.

-deter-men ΔT and adjusting

The design ΔT of the the system is 5K. This means that the temperature difference between the water-inlet and outlet of the Opticlimate must be maintained at 5K. To deter-men this value press the S-key short on the remote of the Opticlimate. In the display appears C-01 and a temperature. Using the up-and down keys you can scroll from C-01 up to C-06. To determent ΔT subtract the temperature value C02 from C03.

C02 – Water-out temperature (supply to water cooler)
 C03 - Water-in temperature (return from water cooler)

Example: C02= 45°C
 C03= 39°C -

 $\Delta T= 6^{\circ}K$



-Balancing with manual or auto by-pass

-Adding glycol to the system

In an environment where glycol (antifreeze) in case of a leak could come in contact with food, chemicals or in a pharmaceutical or agriculture plant, propylene glycol must be used. We recommend to use a 20% glycol / water mix. (antifreeze protection -10°C) or more depending on outside conditions.

To determen how much glycol must be added, you need to know the total volume of water in the system. The specification sheets below help to determen how much volume your system contains.



Order nr.	Model	Weight	Dimensions	Sound level	Cooling power	Fan	
1	1-8010	OC Water cooler 4.5KW Compact Ultra light V	7kg	L650xH410xB320	28dB(A)	0,06kW	1 (350mm) 2l
2	1-8020	OC Water cooler 9KW Compact Ultra light V	13kg	L1200xH410xB320	31dB(A)	0,12kW	2 (350mm) 4l
3	1-8030	OC Water cooler 12KW Industrial grade V	63kg	L1025xH933xD600	32dB(A)	0,27kW	1 (500mm) 6l
4	1-8040	OC Water cooler 14KW Compact Ultra light V	19kg	L1750xH410xB320	33dB(A)	0,18kW	3 (350mm) 6l
5	1-8050	OC Water cooler 17KW Industrial grade V	76kg	L1025xH933xD600	32dB(A)	0,27kW	1 (500mm) 11l
6	1-8060	OC Water cooler 18KW Compact Ultra light V	26kg	L1200xH810xB320	34dB(A)	0,24kW	2x2 (350mm) 8l
7	1-8070	OC Water cooler 32KW Industrial grade V	125kg	L1600xH983xD600	40dB(A)	0,6kW	1 (630mm) 19l
8	1-8071	OC Water cooler 32KW Industrial grade H	125kg	L1600xH1050xD943	40dB(A)	0,6kW	1 (630mm) 19l
9	1-8072	OC Water cooler 32KW Compact Ultra light V	52kg	L1750xH810xD320	36dB(A)	0,36kW	3x3 (350mm) 21l

Model	Evaporator volume (m3)	Condensator volume (m3)	Estimated Pipes volume (m3)	Total volume (m3)	Total (Ltr)
3500pro3 (Plate type heat exchanger)	0.000845454	0.0013	0.000304573	0.002450027	2.45
6000pro3 (Plate type heat exchanger)	0.001320571	0.002	0.000316842	0.003637413	3.36
10000pro3 (Plate type heat exchanger)	0.00229044	0.0033	0.000318623	0.005909063	5.90
15000pro3 (Plate type heat exchanger)	0.003271472	0.005	0.000335321	0.008606793	8.60
3500pro3 HC (Plate type heat exchanger)	0.000845454	0.0013	0.000304573	0.002450027	2.45
6000pro3 HC (Plate type heat exchanger)	0.001320571	0.002	0.000316842	0.003637413	3.36
10000pro3 HC (Plate type heat exchanger)	0.00229044	0.0033	0.000318623	0.005909063	5.90
15000pro3 HC (Plate type heat exchanger)	0.003271472	0.005	0.000335321	0.008606793	8.60

1 meter of 25mm PE piping has a volume of 0,35ltr

1 meter of 32mm PE piping has a volume of 0,60ltr

Example:

A 15000pro3 high capacity (HC) on 1 x 17KW and a total pipe length of 100mtr x 32mm = 8.6 ltr + 11ltr + (100x 0.6ltr=60ltr) = 79.6ltr total volume. You need 16ltr of glycol to make a 20% glycol/water mix.

When adding glycol to an empty system, use a pump to add the calculated amount of glycol, then top-up the system with water until the static pressure is 1.5bar.

When adding glycol to system that is already pressurised and full with water, remove more water than the amount of glycol you want to add, add the calculated amount of glycol and top-up with water until the static pressure of the system is 1.5bar.

Note: -

- Pure water cools better than a glycol/water mix
- A water glycol mix prevents corrosion
- Use an automotive antifreeze tester and a sample of the glycol/water mix to check the freezing-point of the mix. Make sure the mix is correct for weather conditions in your area.

Design sheet

Number of Opticlimates on 1 water cooler _____

Opticlimat model (s) _____ **pro3/pro4**

Distance between Opticlimates and water cooler _____ **mtr**

Heat load Opticlimates (KW) _____ **KW**

Max. outside temperature _____ **°C**

Min. outside temperature _____ **°C**

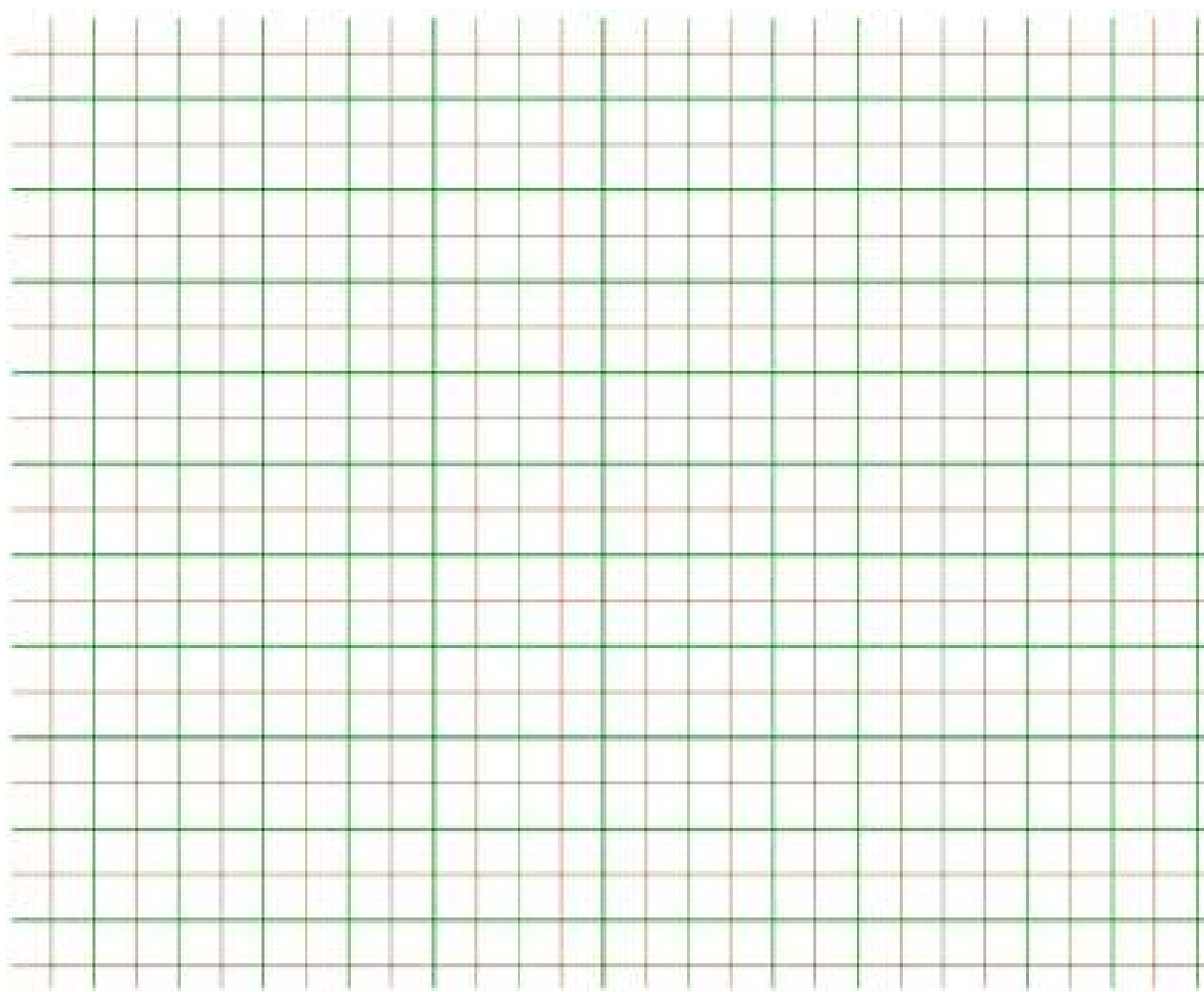

Sketch of the situation