

ARTWORK

Parquet, the stage for your life.

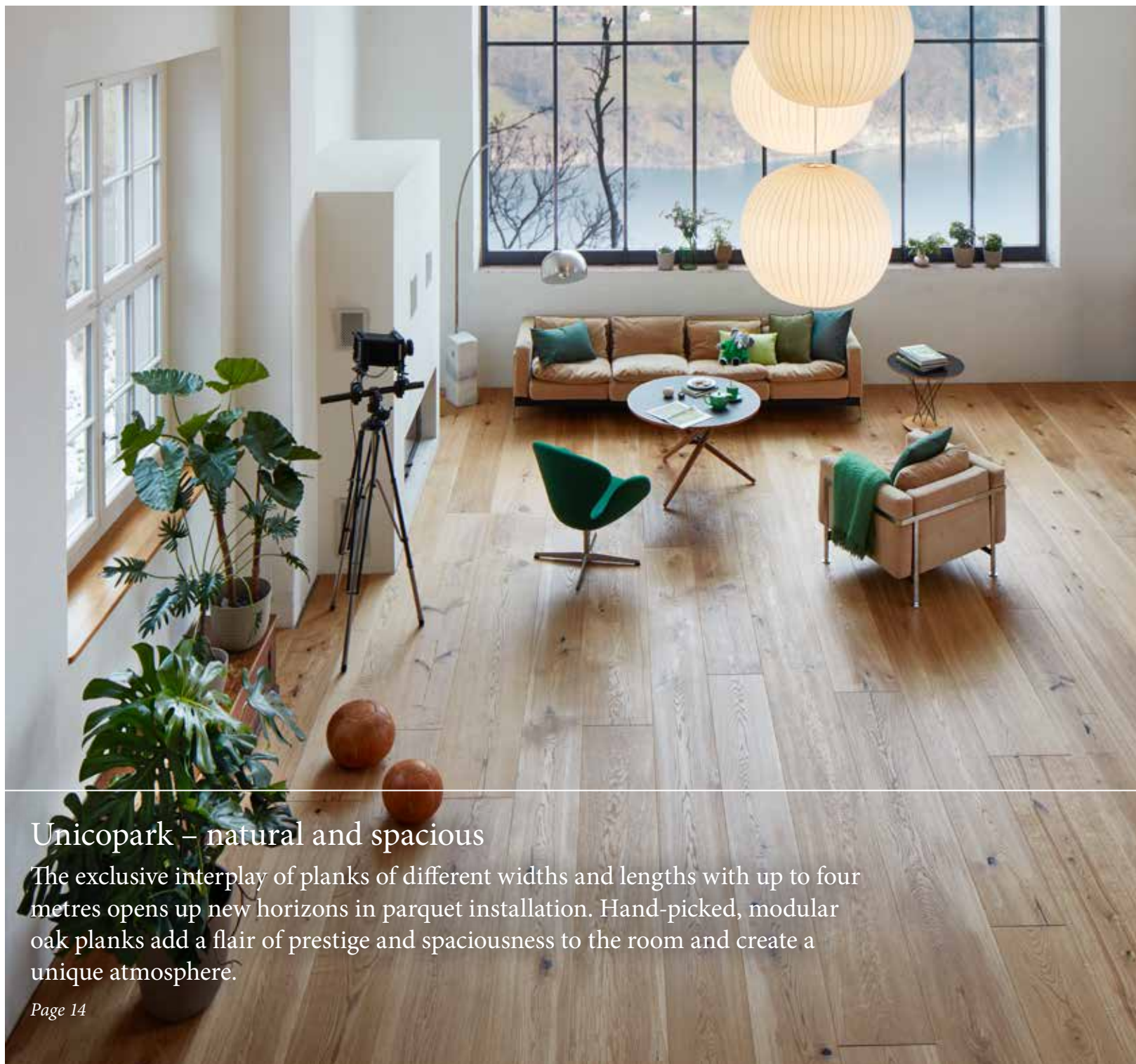

Unicopark – natural and spacious

The exclusive interplay of planks of different widths and lengths with up to four metres opens up new horizons in parquet installation. Hand-picked, modular oak planks add a flair of prestige and spaciousness to the room and create a unique atmosphere.

Page 14

BAUWERK®
Parquet

*The natural structure
of each individual plank
is elaborately crafted.*

UNICOPARK

Oak Fulvo Handcrafted, lively

- 2 Editorial
- 4 Bauwerk Expertise

12 NEWS & TRENDS

- 14 Unicopark & Unicopark Handcrafted
- 20 True Colours Edition «Nuvola» & «Roccia»
- 22 The many facets of grey
- 24 Used-Look: Parquet that tells stories
- 26 Colour Blocking

28 THE BAUWERK RANGE

- 30 Unicopark
- 32 Silverline Edition
- 36 Casapark
- 40 Villapark
- 48 Studiopark
- 52 Formpark
- 56 Trendpark
- 60 Cleverpark
- 68 Strip parquet
- 72 Solid parquet
- 74 Wood accessories
- 76 Colours, sizes and surfaces

82 KNOWLEDGE

- 84 Good reasons to choose parquet
- 86 Parquet is taking over our homes
- 90 Renovation of and with parquet
- 92 Colour change due to light source and light incidence
- 94 The way of parquet

96 SERVICE

- 97 Inspiration & Guidance
- 98 Our service for you
- 100 Worlds of parquet & Showrooms
- 100 Imprint



84 Good reasons to choose parquet



86 Parquet is taking over our homes



90 Renovation of and with parquet



92 Colour change due to light source and light incidence

Dear reader,

Today, feeling well in every way within our own four walls is more important than ever. Our homes have become more than just a place to retreat to and recharge our batteries. They have taken on a central position in our lives. A home must now meet new expectations, and offer space for work, home schooling, sport and creativity.

This makes the choice of interiors a matter not only of visual design, but also of well-being. Parquet can have a positive effect on the entire atmosphere of a room, and therefore our well-being, like no other type of flooring. Appealing to the senses, sustainable, timelessly beautiful and 100% healthy for living: a true piece of nature under your feet and a substantial boost to your quality of life.

Did you know that parquet is also an excellent solution for renovations? It can simply be laid over existing flooring, increasing the value of any home, because of its longevity, and because it can be renewed and remodelled: lasting for the present, the future, and generations to come.

The individual nature of parquet takes on literally large dimensions with our new Unicopark format (see p. 14). We plan every single plank exclusively based on your floor plan in order to create a unique interplay of different plank widths and lengths of up to four metres. Traditional methods are used to refine the 'Handcrafted' surface and highlight the wood's elements, creating elegant accents and an unmistakable tactile experience.



The True Colours Edition, created in conjunction with furniture and interior designer Gesa Hansen, is a homage to nature in all its facets. This year, its range saw the addition of two new tones of grey: 'Nuvola' and 'Roccia', which tell their very special story (see p. 20).

With lots of passion and Swiss precision, Bauwerk produces all its parquet in Europe, with most of it currently coming out of its main facility in Switzerland, making the St. Margrethen factory the first Cradle to Cradle®-certified parquet manufacturing plant in the world. With a vision of a zero-waste economy and continuous reuse 'from cradle to cradle', Bauwerk and its products guarantee more sustainability in value, more material safety and the certainty of making a positive contribution to the health of humanity and the environment. This magazine, too, now comes from a Cradle to Cradle®-certified printing plant, printed on certified paper, so that we are even more careful in the

handling of nature and its resources.

Let the following pages, our social media profiles and our website inspire you. We are also happy to invite you to experience the many advantages of Bauwerk's parquet in person, at one of our showrooms!

Christian Steiner
Director Bauwerk Group Total Quality Management

TRUE COLOURS EDITION

Designed by Gesa Hansen

Development of the True Colours Edition with Gesa Hansen
more on page 20



INGENIOUS DESIGN



Bauwerk design is a thoughtful design. Bauwerk creates products that are aesthetically pleasing and always convincingly functional.

For us at Bauwerk, design means boundless beauty combined with intelligent function. Countless aspects are already taken into consideration before the first draft of any design. Our designers thoroughly explore the possibilities of wood and the wishes of our customers. And all this long before the first prototype becomes a reality and a new floor finds its place in your home.

Thanks to our flair for aesthetics and a pronounced sense of intelligent functionality, the designers at Bauwerk Parquet accentuate the unrivalled features of authentic wood again and again. Colours and surfaces combine with technical innovation and enable new design options for different needs - high-quality and timelessly beautiful.

Thoughtful design anticipates the function, the use and also the lifespan of an object. According to the principle of 'Form follows function', everything produced from Bauwerk is simple, intuitive and sensible. This is how we fulfil our customers' wishes and ensure at the same time that the wood is used in a conscious, sustainable manner.



INNOVATIVE PARQUET SOLUTIONS

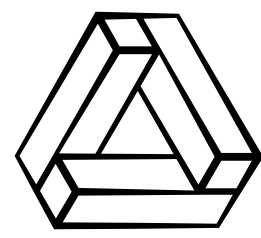

Bauwerk Parquet develops innovative parquet solutions and uses technologies to share real added value with our customers.

Innovative strength is deeply anchored in the company's DNA of Bauwerk Parquet. We have been researching, developing and designing with unwavering dedication since the 1940s. New processes and technologies help us to further strengthen the versatility of wood as a material in a way that is tangible and usable for our customers. Bauwerk's solid parquet has taken the world by storm, and after the invention of 2-layer parquet, Bauwerk continues to set new standards with innovative, creative solutions, such as Formpark.

To us, innovation means much more than just a new or improved product. It is an attitude that shapes our way of thinking and acting. To us, innovation also means that our customers can see a virtual visualisation of their homes featuring various parquet floors. Or we can provide them with suitable solutions for maintaining or renovating wooden floors. As a pioneer for sustainability and ecology in the industry, Bauwerk Parquet has continuously improved parquet solutions. Bauwerk was the first company worldwide to start certified production based on the 'Cradle to Cradle™' principle.

Innovative parquet solutions - we are constantly driven to make your life both easier and more beautiful with our wooden floors. Our passion drives us every day, again and again.

SWISS PRECISION

BAUWERK
Parkett

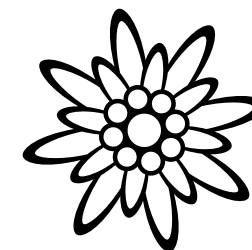

Bauwerk Parquet lives the Swiss passion for precision and makes it tangible for our customers in every product.

Our commitment to Swiss tradition goes back to the founding of the company in the 1940s. To this day, the name Bauwerk stands for precision, reliability, high quality and naturalness. It is the result of a long history of hard work, utmost care, a pronounced love for wood and a unique understanding of quality. Passion, care and traditional Swiss precision have always guided our thinking and acting. This precision is a central pillar of the trust our customers have in us.

We live Swiss precision. Our employees are passionate about creating unique parquet floors from the beautiful material that is wood. This attitude should shape the entire experience for our customers and inspire them through the Bauwerk brand. From the product and its processing to professional advice and the right care product: everything fits together in perfect coordination. This is how our floors become your reliable lifetime companion.



PERSONAL WELL-BEING



Bauwerk parquet fills your home with life and nature, warmth and security for a personal sense of well-being and comfort within the four walls of your home.

Nowadays we long for real things, for a piece of real nature. We want real materials that we can touch, feel and experience with all our senses. We want to consciously perceive and enjoy our living space and the objects that surround us. Nature and its products help us to find and maintain our inner balance. This also applies to parquet flooring made from real wood that offers a unique tactile sensation.

As the largest 'piece of furniture' in terms of surface area, a wooden floor fills your home life with warmth and ensures a sense of well-being in every room. As a healthy, sustainable, quality product, parquet gives us a sense of certainty that we've made the right choices for ourselves, our loved ones and the environment in the long term. As a pioneer, Bauwerk underscores healthy living with systematic checks by independent third parties, such as the eco-institute the Sentinel-Haus Institute, and certificates and standards, such as the FSC label and the demanding 'Cradle to Cradle™' certificate. This means that the products are natural and manufactured in an eco-friendly way, and that they can be recycled once their service life is over.

Parquet from Bauwerk gives us a perfectly balanced, everyday living atmosphere and a naturally healthy room climate for sensual perception, for intense sensations, for positive inspiration and for new energy.

NEWS & TRENDS

Materiality & colour reinvented

Whether finely structured, smooth, light or rustic: parquet is a valuable piece of nature that enriches country-house interior styles just as much as modern ones – and gets to the heart of each individual's tastes. The natural aesthetics of structured surfaces, rustic grading or light shades appear warm, authentic and lively. In this way, liveliness is combined with authenticity, and simplicity with real experiences.

Discover our new products...

1 | Unicopark Handcrafted Oak Avorio; 2 | Villapark True Colours Edition Oak Nuvola; 3 | Casapark 181 Oak Tabacco Used-Look; 4 | Studiopark Oak Creta; 5 | Villapark Oak Crema

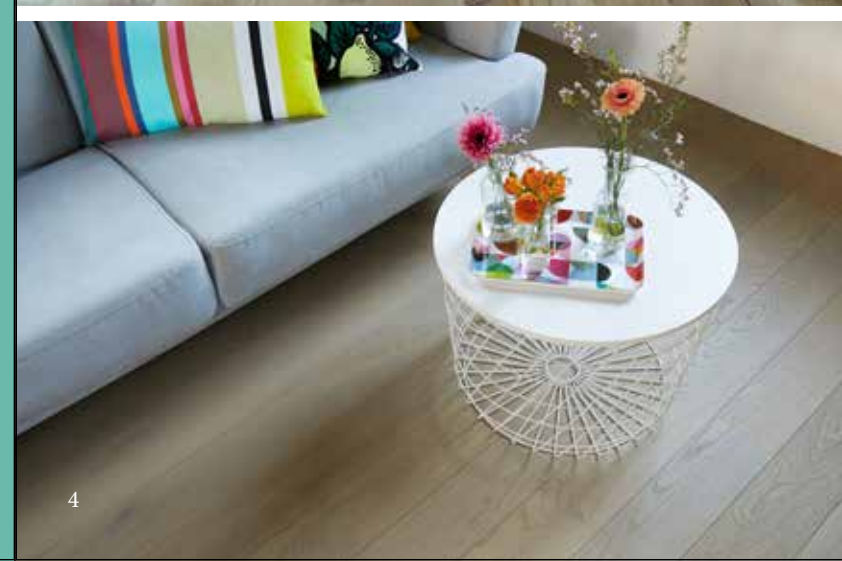

UNICOPARK

Handcrafted



These hand-picked, modular oak planks in different formats add a flair of prestige and spaciousness to the room, creating perfect scenery for your life.

Natural IN SPACIOUSNESS

Unicopark & Unicopark Handcrafted

The interplay of 1-strip planks in five different widths and lengths of up to four metres creates a flair of prestige and spaciousness to the room, making Unicopark live up to its name. Every plank is hand-picked and unique, and the natural character of its wood is lovingly refined. Thanks to modularity in its installation, Unicopark provides the perfect stage for your life.

Showing off the space in every way

Thanks to its impressive formats, carefully selected oak wood, and the precision processing of the material, Unicopark highlights the character of exclusive and spacious rooms.

Careful planning of every single plank

The combination of planks of different widths and lengths of up to four metres creates a unique atmosphere. A single Unicopark plank provides enough surface area to accentuate the spectacular natural structure and character of the wood. Bauwerk's experts plan the arrangement of different lengths and widths of the planks based on your floor plan, taking the individual features of your room into account. This way, the floor, being the biggest piece of furniture in the room, gets the attention it deserves.



Unicopark Oak Gold, rustic

Unicopark is available in the following colours:



Oak Farina Oak Avorio Oak Oak Gold Oak Fumo Oak Caffè

Unicopark Handcrafted is available in the following colours:



Oak Avorio Oak Mandorla Oak Fulvo



UNICOPARK
Oak Avorio, lively

Parquet for all senses

In these times, when many things only manifest themselves in a digital way, moving away from palpable material substance, people long for the personal and the authentic. Natural materials, such as wood, have a positive influence on our well-being, and with the modular and spacious Unicopark format, there is sufficient space to create this effect. The hand-crafted surface appeals to all senses, inviting you to come in and slow down.



Natural wooden planks: perfected by hand

Unicopark Handcrafted stands out with its natural aesthetic and perfect imperfections. The manually refined surface produces an extraordinary interplay of colour, structure and integrated details, preserving the natural quality of the wood. The knots and cracks are carefully highlighted through elaborate manual procedures. Traditional brushing and planing techniques underscore the structure of the wood and put a spotlight on the refined surface. All this makes every plank a unique object, providing elegant accents and a very special tactile experience, thanks to its charming irregularities.

- 1 | Unicopark Oak Fumo, rustic
- 2 | Unicopark Oak Farina, lively
- 3 | Unicopark Oak, lively
- 4 | Unicopark Oak Fulvo Handcrafted, rustic

Back to the ROOTS

True Colours Edition by Gesa Hansen

Travel back to the roots, brush against nature, feel the elements: with True Colours, furniture and interior designer Gesa Hansen has created a unique edition for Bauwerk. Inspired by nature, by her flair for design and love of wood as a material, she worked together with Bauwerk to develop four fascinatingly nuanced colours.

Colours – inspired by nature

The colours Canneto, Terra and Lava, developed in the first edition, range from a bright beige to a rich brown. The new colours Nuvola and Roccia complement the current earthy palette with a contemporary grey in different shades: With every grey telling its own story. They are available as large, 1-strip planks in Villapark format, and are made at Bauwerk's main facility in St. Margrethen with Swiss precision.

Intense depth effect

The multi-layer coating technique Next, developed by Bauwerk, perfectly accentuates the colours of the True Colours Edition and gives it an intense depth effect. This results in a distinctly natural look, highlighting the originality of the True Colours Edition and the unique character of every plank, in all its facets.

Villapark True Colours Edition is available in the following colours:



- 1 | Villapark True Colours Edition Roccia, lively
- 2 | Villapark True Colours Edition smoked Lava, lively
- 3 | Villapark True Colours Edition Nuvola, lively



The many facets of GREY

Timeless, elegant, and refined

Grey is just 'Wow'! Because grey is more than just a neutral colour and is anything but dreary. It presents itself in many different shades and never fails to look fresh. No other colour goes so well with others. Be it alone or in combination with other colours, only grey can accentuate the right parts of space so precisely.

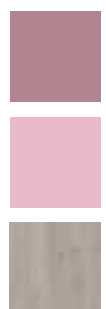

Sasso

Versatile appeal

Grey is the secret star of the world of interior design. Depending on the colour nuance, grey can look cool or warm, sober, or lively. Combined with wooden floors and furniture, it creates a cosy ambiance. When put together with white, grey creates a very noble effect, and when accompanying gentle pastels, it offers a soft and discreet contrast.



Farro



From décor to floors

In interior decoration, we find grey not only on walls, furniture, and accessories: it is also subject to modern interpretation on floors. Grey parquet suits every style of interiors and fills the room with a calm appeal. The room looks more spacious if the colours of the walls and the floor merge. If the floor is to be the highlight of the room, this can best be achieved with light furniture and white walls.



Creta

Balance in the big picture

Using grey is particularly good when combining different colour shades, surfaces and textures. Grey brings bright colours out in just the right way, without making them look garish. Grey wonderfully combines not only with other colours, but with other greys, and putting lighter and darker tones of grey together creates a modern and stylish atmosphere.

- 1 | Cleverpark Sasso, calm
- 2 | Studiopark Farro, lively
- 3 | Studiopark Creta, lively

Parquet that tells STORIES

Used-Look surface treatment



Used-Look products tell a story and add warmth to a room. The worn edges and beautiful patina are characteristic of these trend products.

Modern vintage charm

The patina makes the structure of the wood clearly visible, creating a unique charm that captivates and elicits dreams of bygone days. It is exactly because of this used appearance that these floors are a perfect choice for a modern interior style with personality.

There is a Tobacco-coloured, Used-Look version in the Casapark, Trendpark and Unopark formats. Casapark also has one in the colour Fango, and Trendpark and Unopark have a Deserto-coloured Used-Look version, offering the right nuance for every taste. All Used-Look surfaces are natural-oiled.

The manufacture

Used-Look surfaces are made thanks to an elaborate process, developing their unmistakable character in an enormous bath. The planks are thoroughly washed with pyramid-shaped stones, similarly to the production of faded jeans. Then, the planks undergo special processing with mordants, creating unique traces of patina and use.



Used-Look is available in the following colours:

- Tabacco

Casapark
Trendpark
Unopark
- Deserto

Trendpark
Unopark
- Fango

Casapark



CASAPARK 181
Oak Tabacco Used-Look, rustic

Colour BLOCKING

Bring colour into your life

With classic colour blocking, complementary colours, such as blue and orange, red and green, or yellow and purple are put together, usually as large, single-colour elements and without any pattern, hence 'blocking'. You can also combine colours that no one would ever have expected to work together, like red and pink. For many people, colour blocking is better known from fashion, where playing with colours is encouraged and can get rather adventurous. However, recently, colour blocking has been taking over the world of interior design as well.



Boundless is what pleases

Sharp contrasts and powerful colours add more expression to your home, with the lively interplay between different objects in every room. Adding a complementary tone can make a colour really shine. But how many colours can you include before it all starts to look garish? If you want to play it safe, take two vibrant colours and a neutral one, such as white, grey or black. A minimalist style in interiors will get additional refinement with colour accents in accessories, textiles, or individual pieces of furniture. One thing is certain: it's OK if you like it. Every combination of colours is allowed with colour blocking, as long as it brings joy to your life.

Pantone colours of the year 2021

Two independent colours that highlight how different elements come together to support one another.

Pantone 17-5104
Ultimate Grey

Pantone 13-0647
Illuminating

1 | Apartment in Terneuzen, Photo: Tessa, Product: Unopark Oak smoked Farina; 2 | Hiag Immobilien Switzerland, Photo: Damian Poffet, Product: Formpark, Oak; 3 | Bauwerk Parkett AG, Formpark Mini Oak smoked; 4 | Wellton Park Apartment Moscow, Photo: Dmitry Chebanenko, Product: Formpark Mini Oak smoked

THE BAUWERK RANGE
*Exquisite variety
 for you*

The world of colours in all its shades, the power of shapes and formats, the echoes of ages past and current trends are all sources of inspiration for us. This inexhaustible pool of possibilities opens imaginative doors to new homes. From the meter-long planks of Unicopark to traditional solid parquet with a retro look, which found its way into the world through Bauwerk.

Experience the world of Bauwerk Parquet...

1 | Trendpark Oak slightly smoked; 2 | House Seewis, Photos: Stefan Küng, Product: Villapark Oak Mandorla; 3 | Unicopark Oak Farina; 4 | Formpark Mini Oak Avorio; 5 | Casapark 221 Oak Sasso



Natural and spacious

These hand-picked, modular oak planks in different formats add a flair of prestige and spaciousness to the room, making Unicopark live up to its name.

Showing off the space in every way

Natural materials, such as wood, have a positive influence on our well-being, and with the Unicopark format, there is sufficient space to create this effect. The interplay of 1-strip planks in different widths and lengths of up to four metres produces an unmistakable ambiance. A single Unicopark plank provides enough surface area to impressively accentuating the natural structure and character of the wood: from calm to lively.

Careful planning of every single plank

Unicopark opens up new horizons in parquet installation: Bauwerk's experts plan the arrangement of different lengths and widths of the planks based on your floor plan, taking the individual features of your room into account.

Unicopark is available in the following colours:



Unicopark Handcrafted is available in the following colours:



Unicopark – 2000 bis 4000 x 200/250/300/350/395 x 20 mm

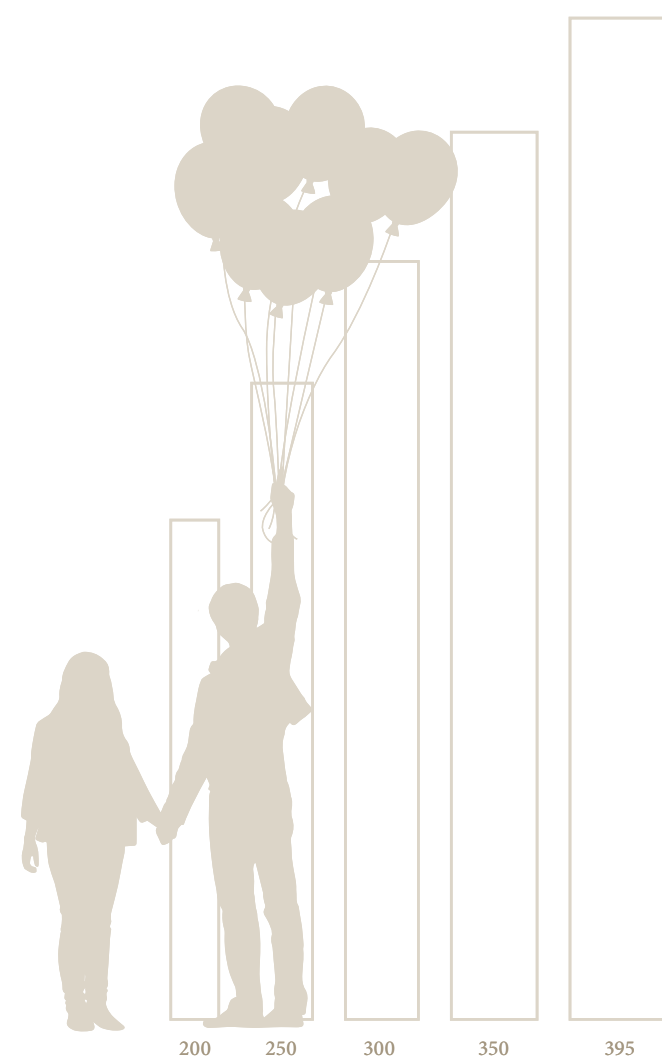

Every plank is hand-picked and unique, and the natural character of its wood is lovingly refined. Thanks to modularity in its installation, Unicopark provides the perfect stage for your life.

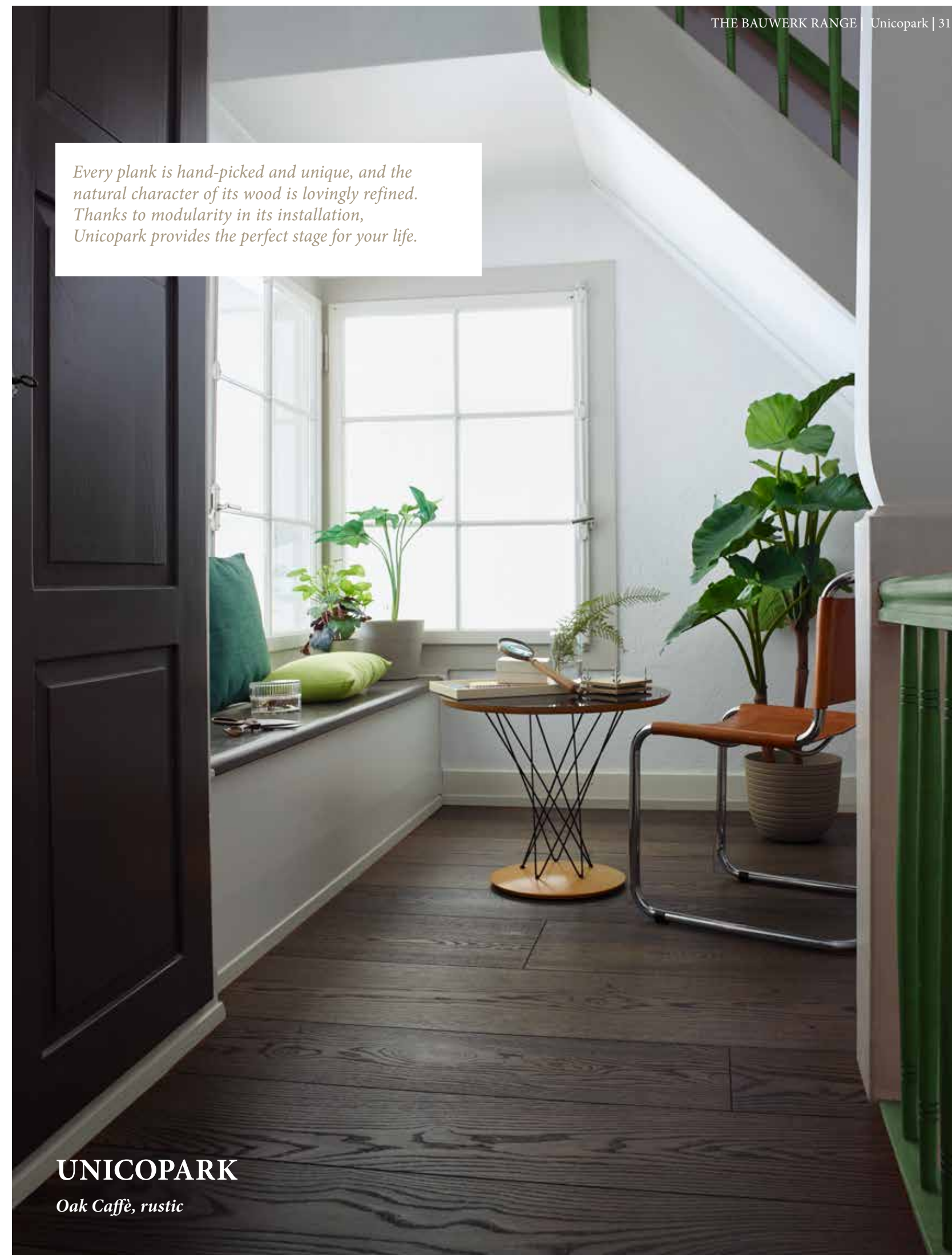

UNICOPARK
Oak Caffè, rustic

SILVERLINE EDITION

Subdued elegance, generously interpreted

There is luxury in simplicity and restraint: the majestic understatement of a wooden floor implies style and individuality. Reduction to the bare essentials becomes the measure of all things.

Three meters long flawless planks

The exclusive planks of the Silverline Edition are carefully hand-picked from particularly fine oaks grown straight upright. The cut of the planks creates fine straight lines running lengthwise. Flawless planks in calm gradings of this length are very uncommon because oaks grow particularly slowly, and producing timber for this format takes decades. The distinctive grading underscores the uniqueness of the wood – so every Silverline floor tells its own story. The special bevels that run around the entire plank further accentuate the impressive length of the almost 3-metre-long Silverline planks.

Bevels emphasise the architecture of the room

They emphasise the extraordinarily spacious dimensions of a Silverline floor, bringing out the natural effect of the spatial architecture and directing the light into the room.

Beautiful expansive large floors are very unforgiving when it comes to mistakes. This is why the Bauwerk master teams in Switzerland are responsible for making the individual planks in the Silverline Edition. Our experts guarantee the exclusive quality with the utmost care.

The Silverline Edition is available in the following colours:



Silverline Edition – 2800 x 260 mm



The exclusive Silverline Edition planks are carefully selected by hand from particularly fine and straight-grown oak trees. Flawless planks of this length are rare. The oaks grow slowly and take decades for this format.



SILVERLINE EDITION

Oak Silver, calm

**VILLA
BREDA
NETHERLANDS**

Product: Silverline Edition, Oak Farina
Architects: Baudoin, Van Alphen Bergers B.V.
Builder: Private
Floor installer: More Floors, Breda
Photos: René van Dongen Fotografie

In other SPHERES

The longevity of a building depends not only on the selection of materials, but also on style. That's why the real art is avoiding fickle trends whenever possible, and building in a well-grounded and discreet way.

Intelligence and sustainability in construction

The discreet, yet powerful architecture and interior designs by Baudoin van Alphen Bergers Architects make it possible to keep this exact balance. In the design of the single-family home in Breda (NL), the focus was thus on producing intelligent and sustainable architecture: as circumstances change, it should be possible to modify the indoor and outdoor spaces of the building throughout its life cycle. This led to the use of low-maintenance materials with little environmental impact.

Bright spaciousness

Raising the building 80 cm gave it a spherical touch and the appearance of floating. The loft has a very open design, with its seemingly endless window facade and a view of the boundless green. This is where the large Farina planks of Silverline Edition were put to good use. With a length of 2.80 m and a width of 26 cm, Silverline Edition is the largest format with a calm grading in Bauwerk's collection. A high-precision bevel was added on all four sides of the Silverline planks to further underscore the effect of their length.



SILVERLINE EDITION

Oak Farina, calm

The 3-layer strip parquet with character

The generously sized Casapark 1-strip oak planks accentuate the individual mood of each room with their distinctive diversity.

The Casapark range is impressive thanks to its distinctive look with vibrant grades, exciting aged surfaces and modern range of colours. The oak planks offer a wide range of design options in the well-known Bauwerk quality – and at an extremely attractive price.

Distinctive variety

The Casapark 1-strip planks, in a generous length of 2,200 mm, are available in three different widths: 139, 181 and 221 mm. The lengthwise bevelling further emphasises these impressive dimensions. Depending on the product, the planks can be installed all in the same width or in a combination of different widths. Casapark is constructed in three layers, its 3.5mm-top layer is well-suited for underfloor heating.

Casapark is available in the following colours:



Casapark Used-Look is available in the following colours:

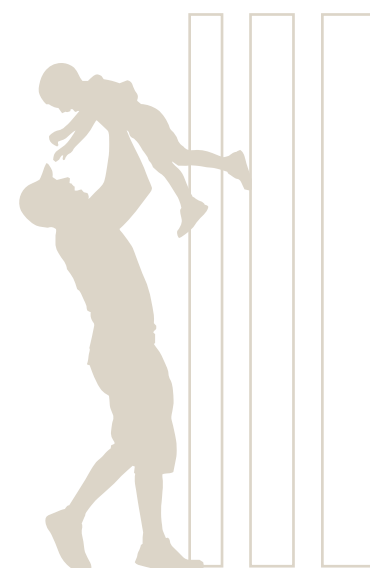

Casapark – 2200 x 139/181/221 x 14 mm 139 181 221

The Casapark country house floor boards with a generous length of 2200 mm are available in three different widths: 139, 181 and 221 mm. The impressive dimension is additionally emphasized by the long side chamfering.

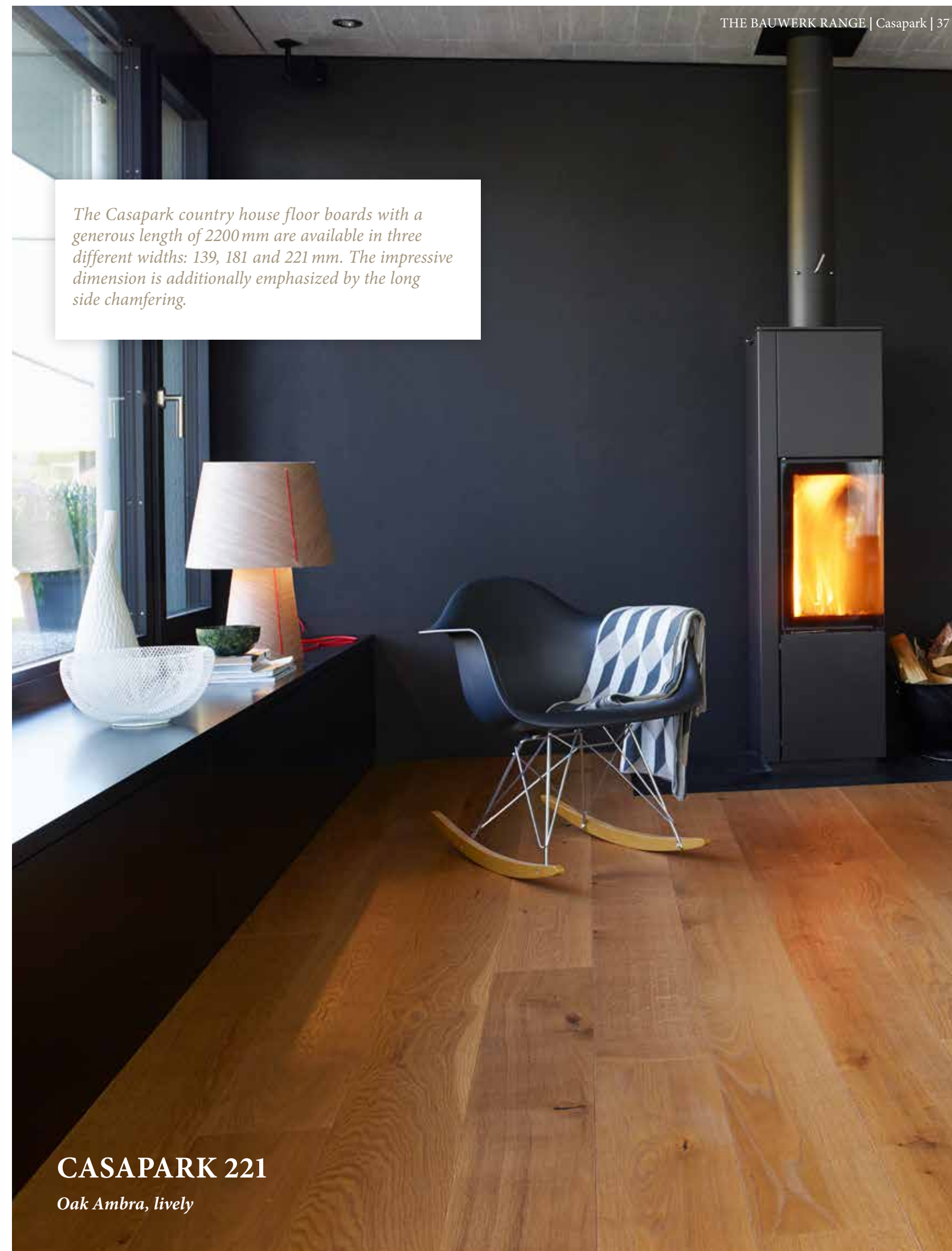

CASAPARK 221

Oak Ambra, lively

**APARTMENT
PIASECZNO
WARSAW**

Product: Casapark 139, Oak Crema B-Protect®
Architects: Anna Tutaj Pielaszek (Tutaj Concept)
Builder: Private
Floor installer: LARES
Photos: Pawl Durka

EXQUISITELY *stored*

A client wanted a new home for their entire family. As the family felt very comfortable in their hometown near Warsaw, and since where they lived was perfect already, moving out was not an option, and the flat had to be rebuilt.

This is the reason architect Anna Tutaj Pielaszek was hired, as she is known for her ability to meet custom requirements. The floor plan, some of the walls, and all the inner workings were rethought and redesigned. In designing the new flat, creating wellthought-out storage space was a central issue. After all, a smart approach to storage not only helps keep things in order, but also supports a more harmonious structure.

Wood as a central element of style

The materials were carefully selected. Wood exudes warmth and cosiness, and in addition to the parquet floor, suitable wood was used for the ceiling and walls. Casapark Oak Crema underscore the elegance of the rebuilt apartment.

Parquet was laid consistently in all rooms: the bathroom was no exception. Light colours, such as light green, pastel tones or white, were chosen to supplement the warm shades of the wood on the floor, ceiling and walls. The client's daughter's wish for a "pink princess room" was also fulfilled.



As a result, every corner was used for this purpose, and every object in the flat has its own place: be it a bicycle on the wall or toys in children's room.



CASAPARK 139

Oak Crema, calm

B-Protect®
natural surface
invisibly protected

1-strip-planks for a sense of wellbeing

The large Villapark 1-strip-planks exude a warm and pleasant atmosphere and bring nature into your home.

Every Villapark plank is unique and reflects the authentic beauty and structure of the different types and colours of wood. This healthy living parquet is the ultimate in versatility.

A sensual feeling when walking barefoot

The Villapark 1-strip-plank comes in the generous dimensions of 2100 x 190 mm. The planks are bevelled lengthwise, which emphasises their size even more. The characteristic brushing ensures a pleasant feeling when walking on them barefoot.

Bauwerk HDF technology

Villapark is based on HDF technology and has a resource-efficient 2.5 mm top layer. With its full-area bonding, the plank ensures a footfall as quiet as a whisper and optimal use of energy with floor heating systems. All Villapark products are tested by independent institutes and are perfect for healthy living.

High production standard 100 % from Switzerland

Villapark is produced at the Bauwerk headquarters in St. Margrethen. This way we can guarantee you get high-quality workmanship, precision, prudent handling of resources and the strictest quality controls. Perfect Swiss quality combined with pleasant and authentic surfaces.

Villapark is available in the following colours:



Villapark True Colours Edition is available in the following colours:



Villapark – 2100 x 190 x 9.5 mm

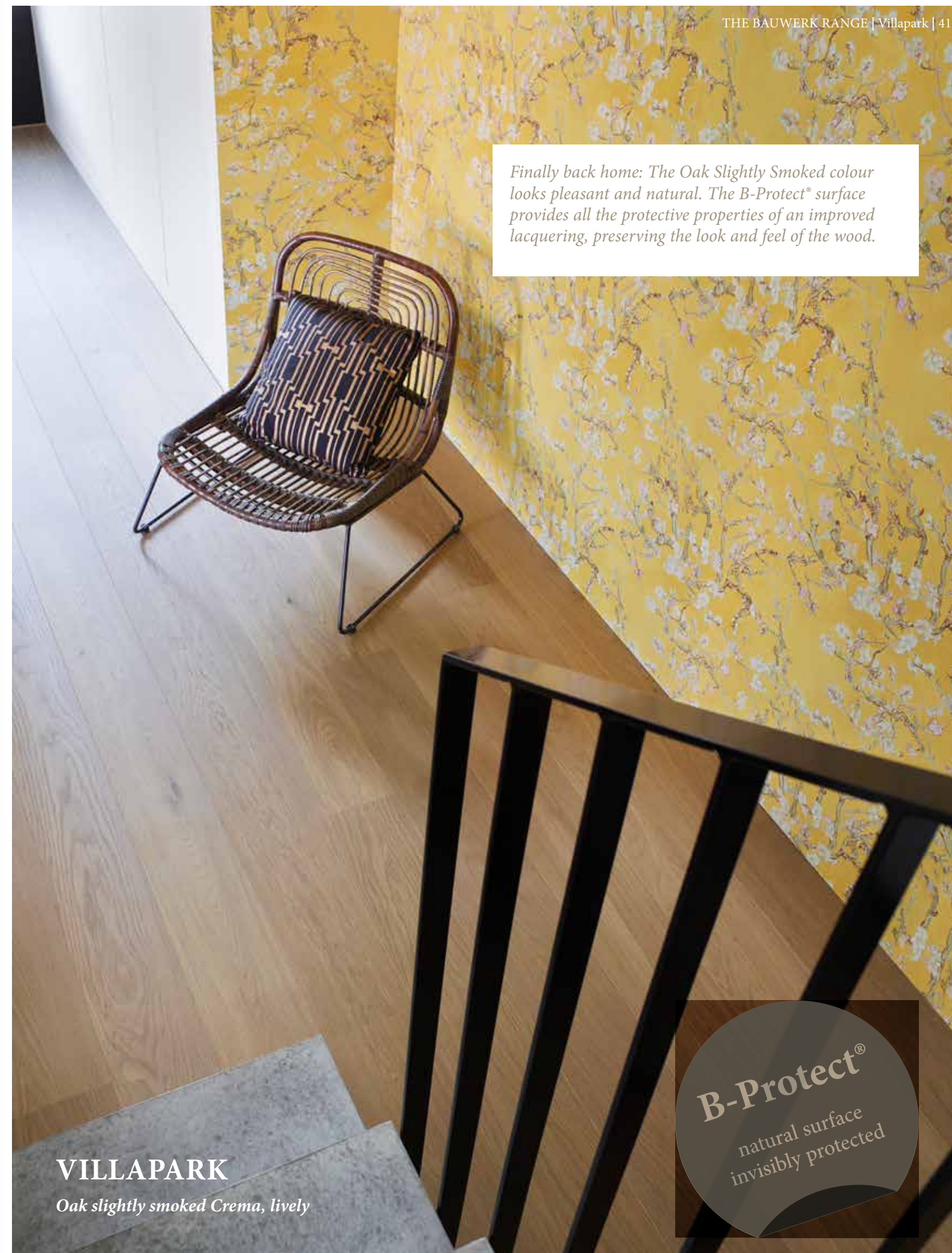

Finally back home: The Oak Slightly Smoked colour looks pleasant and natural. The B-Protect® surface provides all the protective properties of an improved lacquering, preserving the look and feel of the wood.



VILLAPARK
Oak slightly smoked Crema, lively

Strong contrasts characterise the masculine atmosphere of this arrangement. The light Villapark 1-strip-planks with their natural surface ensure a sense of homeliness and cast a fascinating contrast to the more austere look of the furniture.



VILLAPARK

Oak Farina, calm

Lava is a slow force, with wild, determined energy. It fills rooms with timeless stability and provides floors with new diversity.

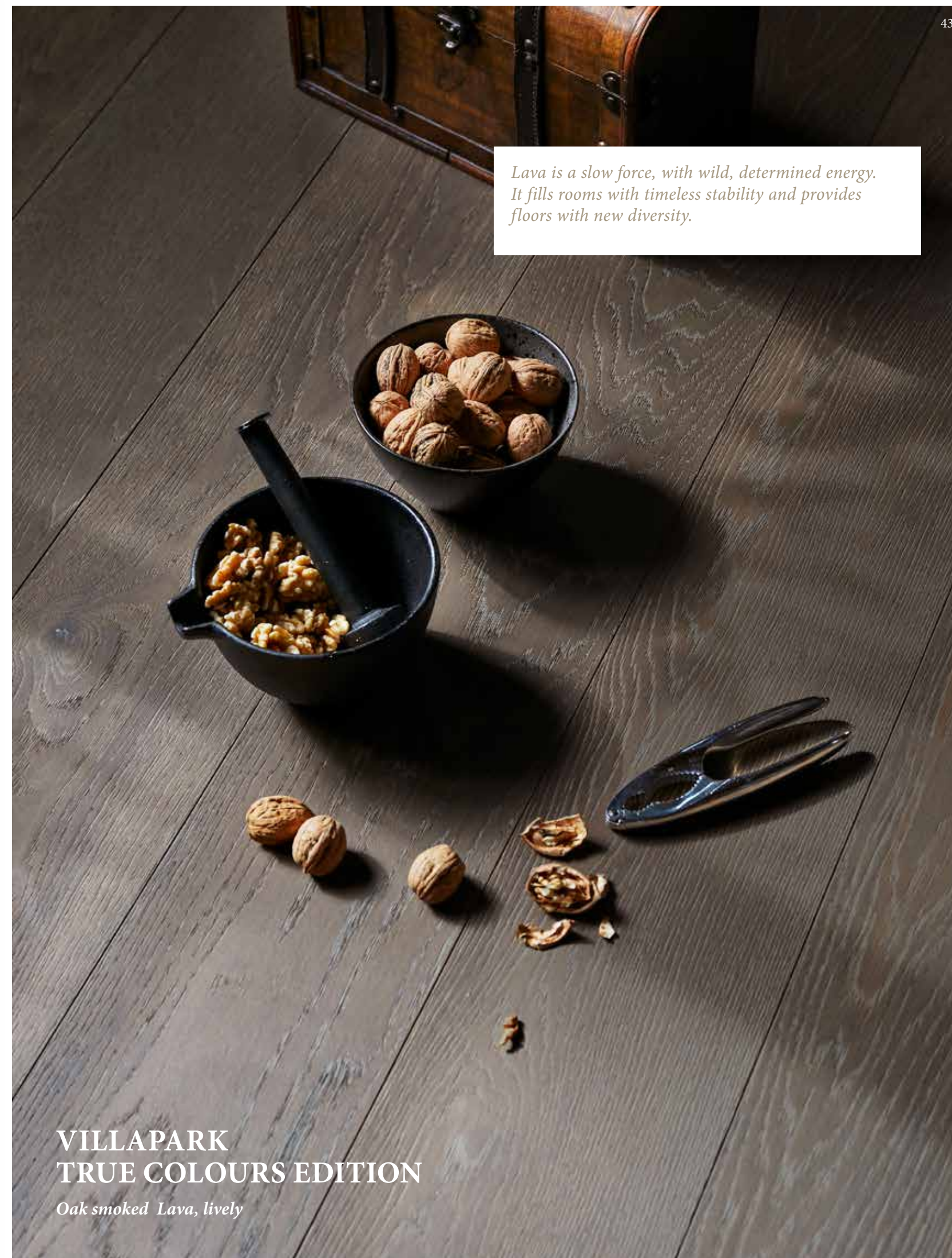

**VILLAPARK
TRUE COLOURS EDITION**

Oak smoked Lava, lively

**UPTOWN-
HOUSES
HAMBURG**

Product: Villapark, Oak Avorio
Architects: Kraus Schönberg
Builder: WPH
Floor installer: K + R Bodenbeläge & Raumausstattungen
Photos: Rolf Otzipka Fotografie | WPH

RENAISSANCE

of an urban idea

Major cities are under constant and growing pressure to meet the demand for more living space. Small-scale densification has not been sufficient to resolve this problem for some time now, and large plots of land available for construction in inner cities have become rare.

Development of 26 designer townhouses

In selecting materials, the interior architect focuses on high quality. The long-style Villapark oak Avorio planks exude a dignified atmosphere. The colour white, used for all the fittings and the staircase, provides a pleasant contrast and allows for a lot of freedom in interior decoration. Especially in the upper duplex apartment, the contrasting materials emphasize the dichotomy between heaven and earth.



“The typology of a townhouse should create a reference for the surrounding area, make flexible use of changing living and work requirements possible, and correspond to local features.”

Ole Klünder, wph company manager



VILLAPARK

Oak Avorio, lively



True luxury means having space and the time to enjoy it. More and more people are creating their own personal aesthetic freedom with the finest materials and textures, exclusive lines and elegant colours – their small oasis in the everyday hustle and bustle of life.

VILLAPARK
Oak slightly smoked Cacao, lively

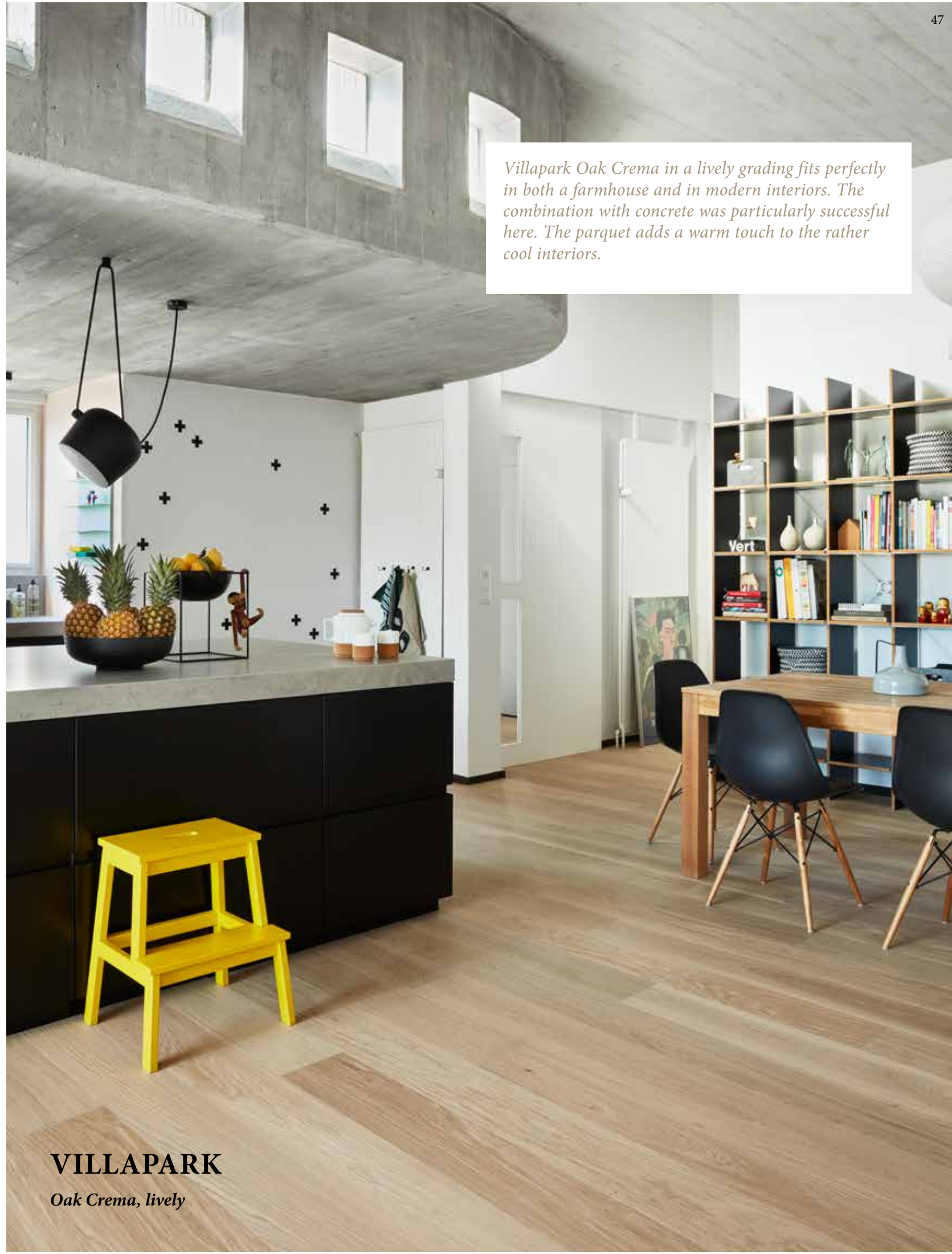

Villapark Oak Crema in a lively grading fits perfectly in both a farmhouse and in modern interiors. The combination with concrete was particularly successful here. The parquet adds a warm touch to the rather cool interiors.

VILLAPARK
Oak Crema, lively

The 1-strip plank that fits in every room

Studiopark offers top flexibility in popular colours. Bauwerk Parkett is versatile and talented in creating perfect, attractively priced one-strip planks.

Making small rooms visually larger

The 1700 x 150mm Studiopark 1-strip plank is also ideal for installing in smaller rooms. Studiopark planks give every room that special touch with their contemporary choice of colours. Studiopark is based on HDF technology and has a resource-efficient 2.5mm-top layer. The length of the plank is subtly accentuated by its bevelled longitudinal edge, creating an open roomy effect.

Top-quality and variety

Thanks to its low installation height, the Studiopark range is ideal for renovations and ensures optimum energy efficiency with underfloor heating systems. Studiopark 1-strip planks are made in Switzerland, tested by independent institutes and completely suitable for living healthy.

Studiopark is available in the following colours:



Studiopark - 1700 x 150 x 9.5 mm

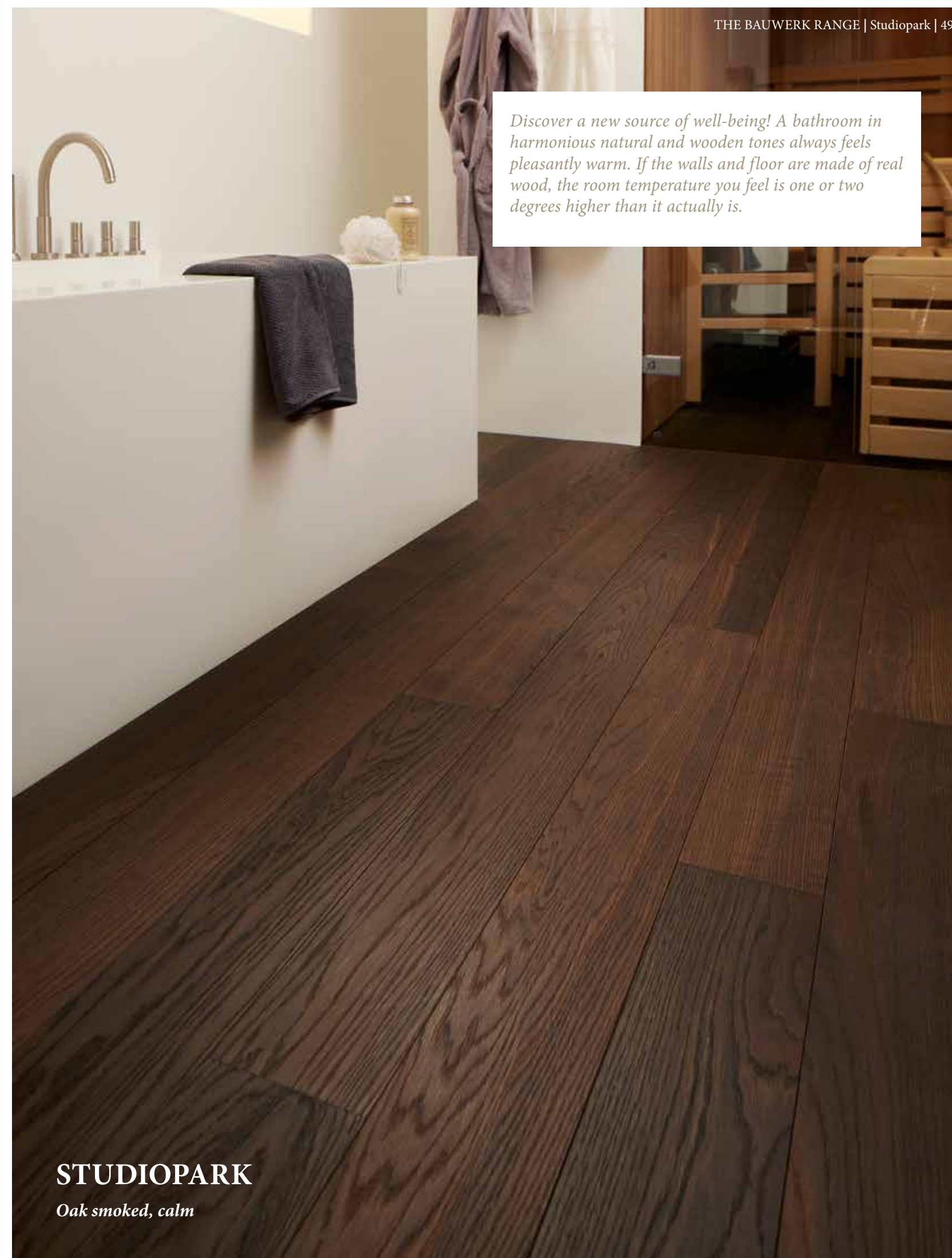
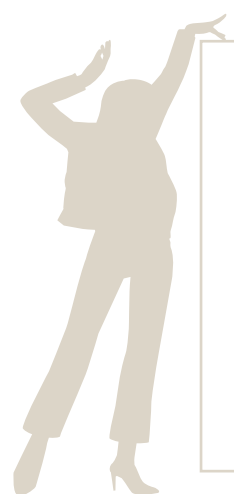

Discover a new source of well-being! A bathroom in harmonious natural and wooden tones always feels pleasantly warm. If the walls and floor are made of real wood, the room temperature you feel is one or two degrees higher than it actually is.

STUDIOPARK

Oak smoked, calm



Cities are alive and dynamic; inspiring trends are constantly reinventing themselves from different influences, cultures and ideas. Although living areas in the city are limited, inexhaustible creativity can create maximum comfort in the smallest of rooms.

STUDIOPARK *Oak Nature, lively*

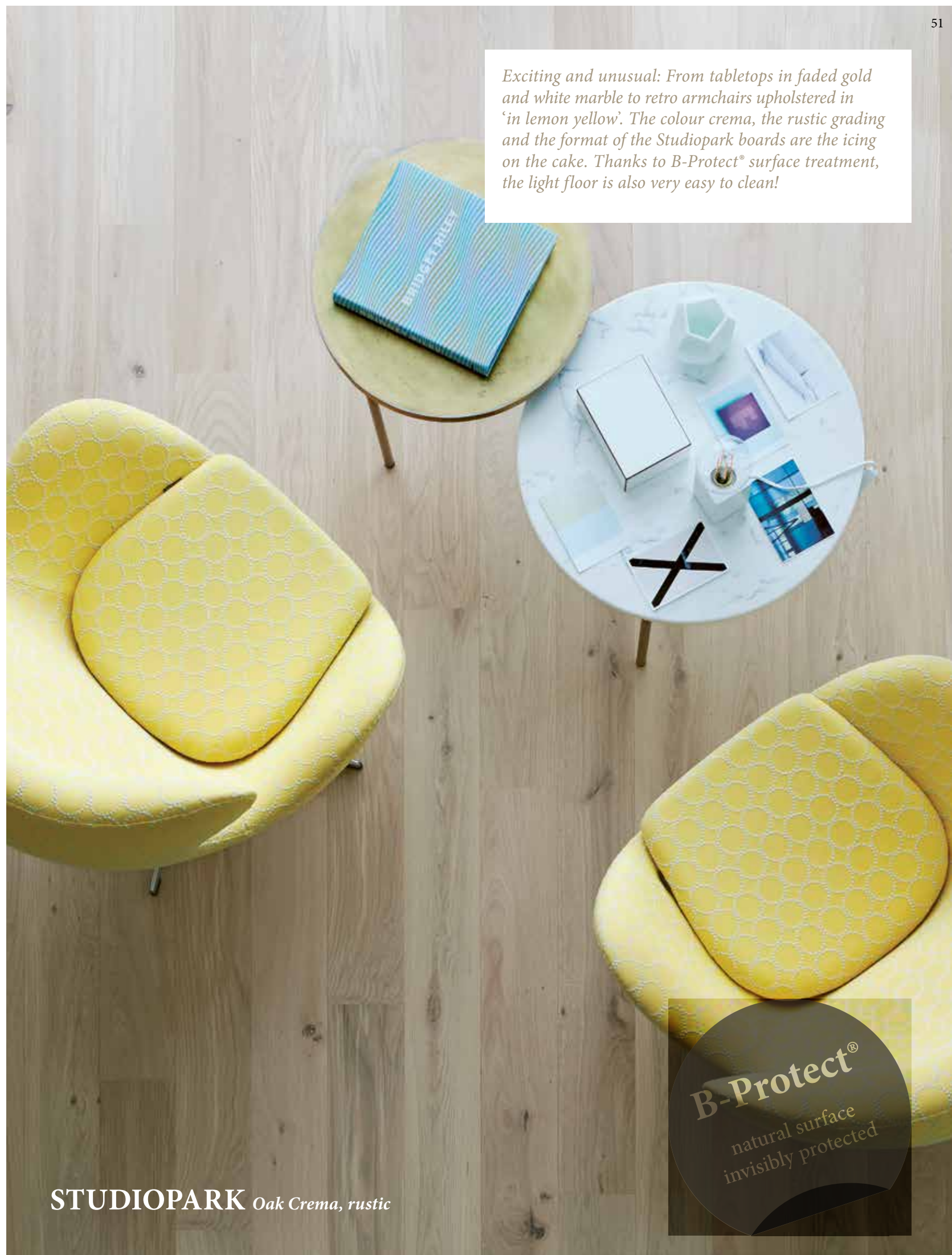

Exciting and unusual: From tabletops in faded gold and white marble to retro armchairs upholstered in 'in lemon yellow'. The colour crema, the rustic grading and the format of the Studiopark boards are the icing on the cake. Thanks to B-Protect® surface treatment, the light floor is also very easy to clean!

B-Protect®
 natural surface
 invisibly protected

STUDIOPARK *Oak Crema, rustic*

Creative laying patterns

The genius behind Formpark lies in its simplicity. All kinds of different patterns appear depending on the installation and the incidence of light – from calm to lively, from classic to avant-garde. Transitions flowing from one pattern to another can also emerge. Our living space can be designed with even greater individuality using Formpark.

Formpark – parquet revised

Although the idea is deceptively simple, it has never been done before. Formpark can be installed either in parallel or at a right angle thanks to its 1:3 and 1:2 proportions.

Formpark Mini – endless creativity on small surfaces

The Formpark Mini format offers countless options for creatively laying parquet on smaller surfaces. Small format for big impact – small surface, big plans? With Formpark Mini, Bauwerk delivers the fascinatingly unconventional looks of Formpark for smaller surfaces, creating architecturally inspired patterns and maximum design freedom.

Formpark and Formpark Mini are available in the following colours:

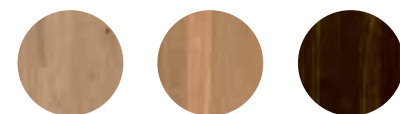

Oak Avorio Oak Oak smoked

Formpark Quadrato:



Oak Crema Oak Oak smoked

Formpark Rombico:

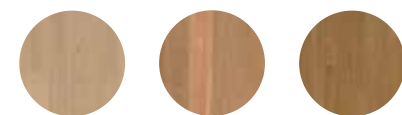

Oak Farina Oak Oak Mandorla

Formpark – 520 x 260 x 11 mm
780 x 260 x 11 mm
Formpark Mini – 380 x 190 x 9.5 mm
570 x 190 x 9.5 mm
Formpark Rombico – 735 x 130 x 9.5 mm
Formpark Quadrato – 650 x 130 x 11 mm



Formpark Quadrato – the revival of herringbone

Formpark Quadrato is suitable for the classic favourite, the herringbone pattern, as well as for other creative laying patterns. The spaciousness of individual planks excitingly reinterprets the classic laying pattern. The patterns impress with their simplicity and timelessness, at the same time being a statement of individuality.

Formpark Rombico – diversity creates space for uniqueness

Formpark Rombico is suitable for the French herringbone, as well as other creative laying patterns. This product is made with utmost precision, the latest machinery and in unique Bauwerk quality. The product's precise fit makes perfect laying possible. The brushed surface gives the floor even more character, highlighting the interplay with light. The dynamic zig-zag pattern shines also with other individual patterns in a clear formal language.

Discover numerous laying patterns on our website
bauwerk-parkett.com > Formpark

Harmonious colours, cosy fabrics and Formpark, Oak Avorio in an exclusive style of installation, transform this room into a place of power.

FORMPARK 520 & 780

Oak Avorio, calm, pattern N° 23

Pure harmony and relaxation: The parquet floor in Formpark Quadrato, Oak Natural, creates a cosy and comfortable atmosphere in the bedroom. Colour highlights in the popular 'greenery' style turn the room into a true oasis of calm.

FORMPARK QUADRATO

Oak Nature, calm, pattern N° 5

The light Oak Farina colour provides sharp contrast to a dark kitchen. The French herringbone laying pattern is particularly good for this spacious room, strengthening the interplay between light and its features.

FORMPARK ROMBICO

Oak Farina, calm, pattern N° 1

Unconventional and trendy

Anything but average: the Trendpark product line, with its generously sized planks, offers unique surfaces for a wide variety of interior designs.

Whether it is the Used-Look optic or the unique color shades: as the largest format without bevels, Trendpark offers a flat look as well as a diverse range of colors.

Longplank: suited to rooms of all sizes

The long-plank format works equally well in small and big rooms. The great diversity of colours, surfaces and structures makes long-plank parquets an ideal choice for a broad range of different spaces. Various Trendpark products, such as those with a Used-Look surface, can add even more individual character. Because of their appearance, these floors make a perfect companion for a modern interior style with personality (see p. 24).

Trendpark is available in the following colours:



Trendpark Used-Look is available in the following colours:



Trendpark -1450 x 130 x 11 mm

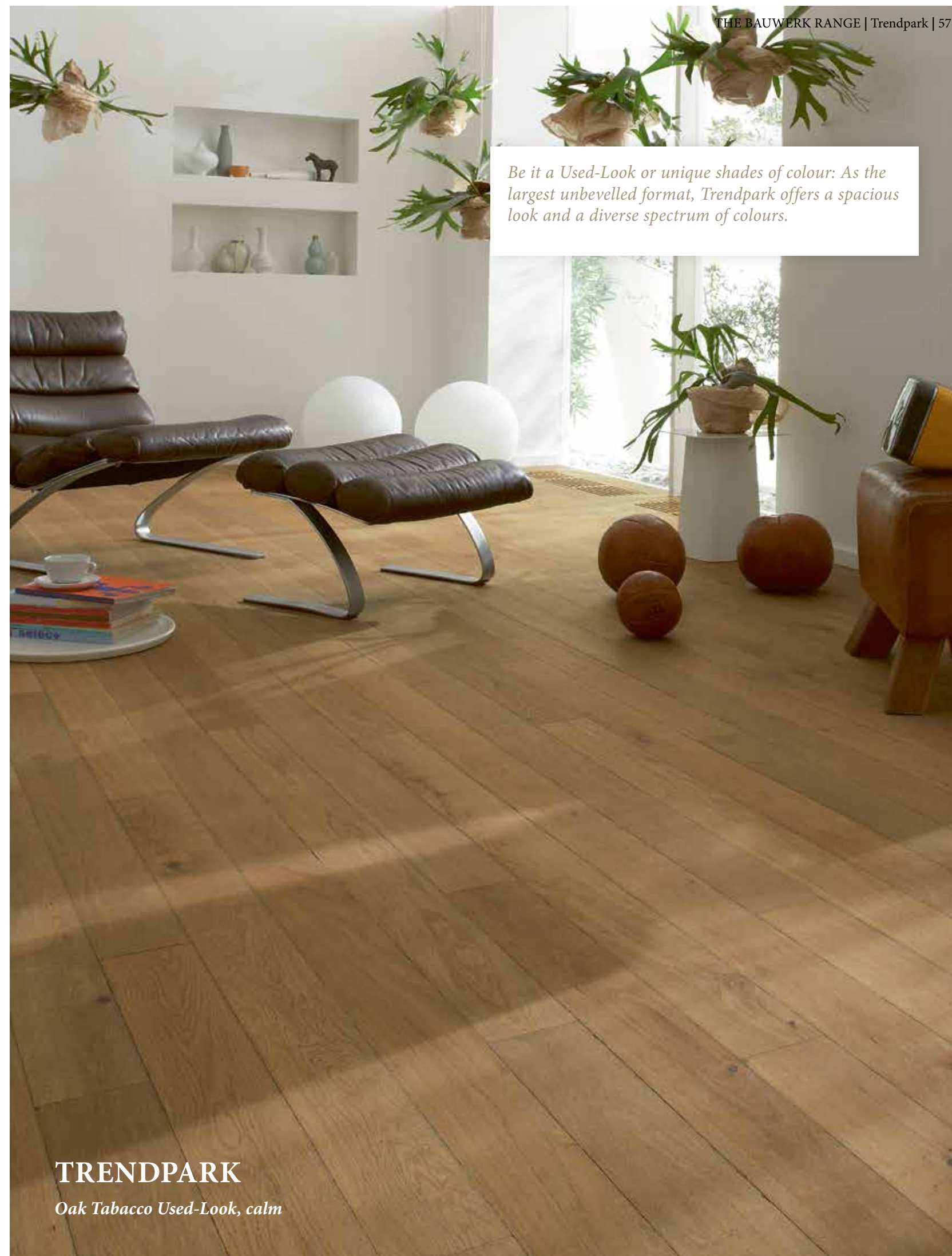
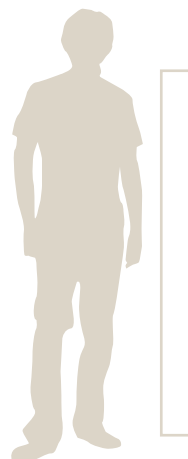

Be it a Used-Look or unique shades of colour: As the largest unbevelled format, Trendpark offers a spacious look and a diverse spectrum of colours.

TRENDPARK
Oak Tabacco Used-Look, calm

Slightly smoked oak provides a pleasant contrast to the light interior of the children's room. The Trendpark planks also create a spacious look.

TRENDPARK

Oak slightly smoked, lively

The spirit of discovery and curiosity has always driven us to explore foreign countries and cultures. Local materials and craftsmanship come together with European influences to create a cosmopolitan living style that we enrich our homes with.

TRENDPARK

Oak Farina, calm

The classy all-rounder

The Cleverpark plank is a true all-rounder. It fits in every room, comes in a wide range of colours, wood types, surfaces and is also available with the Bauwerk Silente technology.

Excellent price-performance ratio

The versatility of the healthy living Cleverpark parquet, which is produced at the Bauwerk headquarters in St. Margrethen, is unique and offers the ideal solution for every taste and every living situation. Cleverpark is representative of high-quality workmanship, precision, the careful use of resources and the most stringent quality controls – plus, real value for money.

Pleasant to walk on barefoot

Whether it is for a spacious living room, cosy nursery or a large office, the 1250 x 100 mm format fits perfectly into any room. The planks create a harmoniously smooth overall look and the brushed finish makes them pleasant to walk on barefoot. Cleverpark is based on HDF technology with a resource-efficient 2.5 mm-top layer. With its full-area bonding, the plank ensures a footfall as quiet as a whisper and optimal use of energy with floor heating systems. All Cleverpark products are tested by independent institutes and are perfect for healthy living.

Cleverpark is available in the following colours:

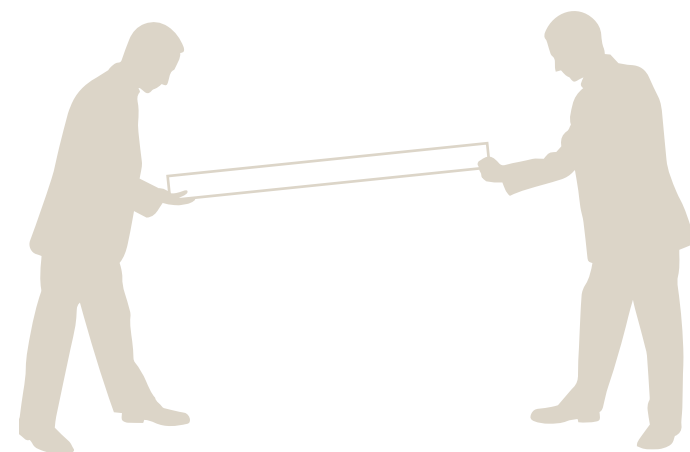

Cleverpark – 1250 x 100 x 9.5 mm

The rustic floor forms the basis for the modern country house look and combines selected individual pieces from different periods. Simple curtains gently filter the light, and a massive old workbench becomes a stage for individually arranged still lifes.



CLEVERPARK

Oak Avorio, lively

**HUCHLER
BARN
WAIBLINGEN**

Product: Cleverpark, Oak Farina, B-Protect®
Architects: Coast Office Architecture
Builder: Private
Floor installer: Fussboden Haag
Photos: David Franck Photographie

Historical WALLS

Protected historical buildings must be treated with a lot of sensitivity and respect: the history and the location both play a decisive role. Architects from the Coast office accepted this challenge. Looking for new premises for their Stuttgart office, Zlatko Antolovic and Alexander Wendlik found a 17th-century barn in Waiblingen that had been empty for years.

The Interplay between the old and the new

The 6-storey half-timbered building is special not only because of the historical city wall that partially acts as an external load-bearing wall for the building, but also because of the steep 55-degree gable roof. The first two floors are used as office space. Black steel stairs along the city wall and the wall-walk lead you to a new flat for the Antolovic family. With four floors and some 150 square metres, this historical 300-year-old barn is home to impressive spaces. Natural materials, black-varnished steel elements and warm colours dominate the interiors. White walls blend in with the light Cleverpark Oak Farina parquet. The planks in this long-plank format create a calm atmosphere. The innovative B-Protect® lacquer completely seals the parquet surface. The innovative B-Protect® coating combines a matt natural look with all the advantages of classic sealing.

A loving attention to details, like the gently cleaned and untreated ceiling beams, or the delicately integrated city wall, are a reminder of days gone by, creating a unique ensemble of old and new when combined with new modern elements.

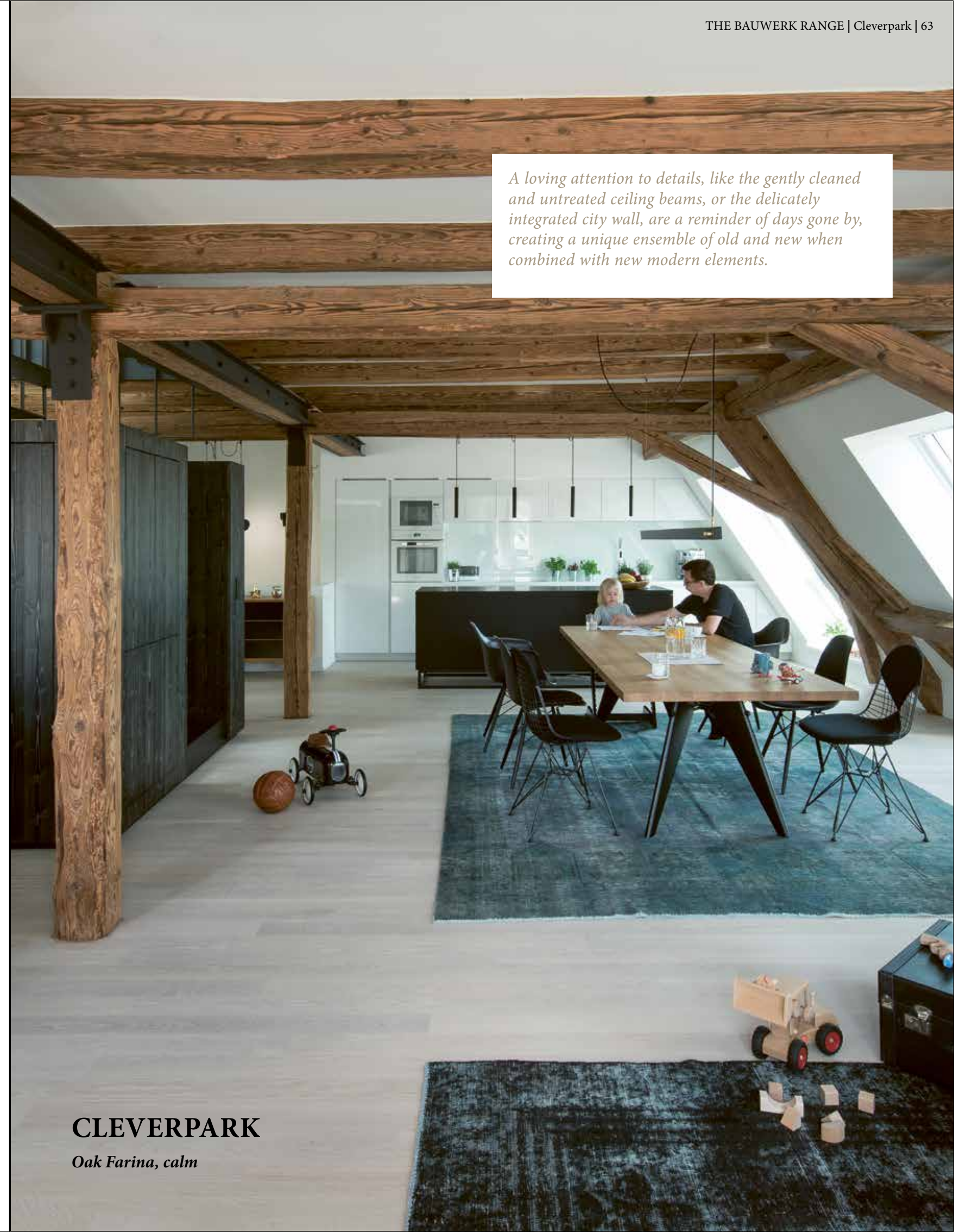

CLEVERPARK

Oak Farina, calm



Parquet also provides pleasant warmth in the bathroom. The light shade of Oak Sasso, B-Protect® creates an exciting contrast with the dark tiled walls. Together with the stylish details, the bath becomes a retreat for moments of calm.



CLEVERPARK

Oak Sasso, calm

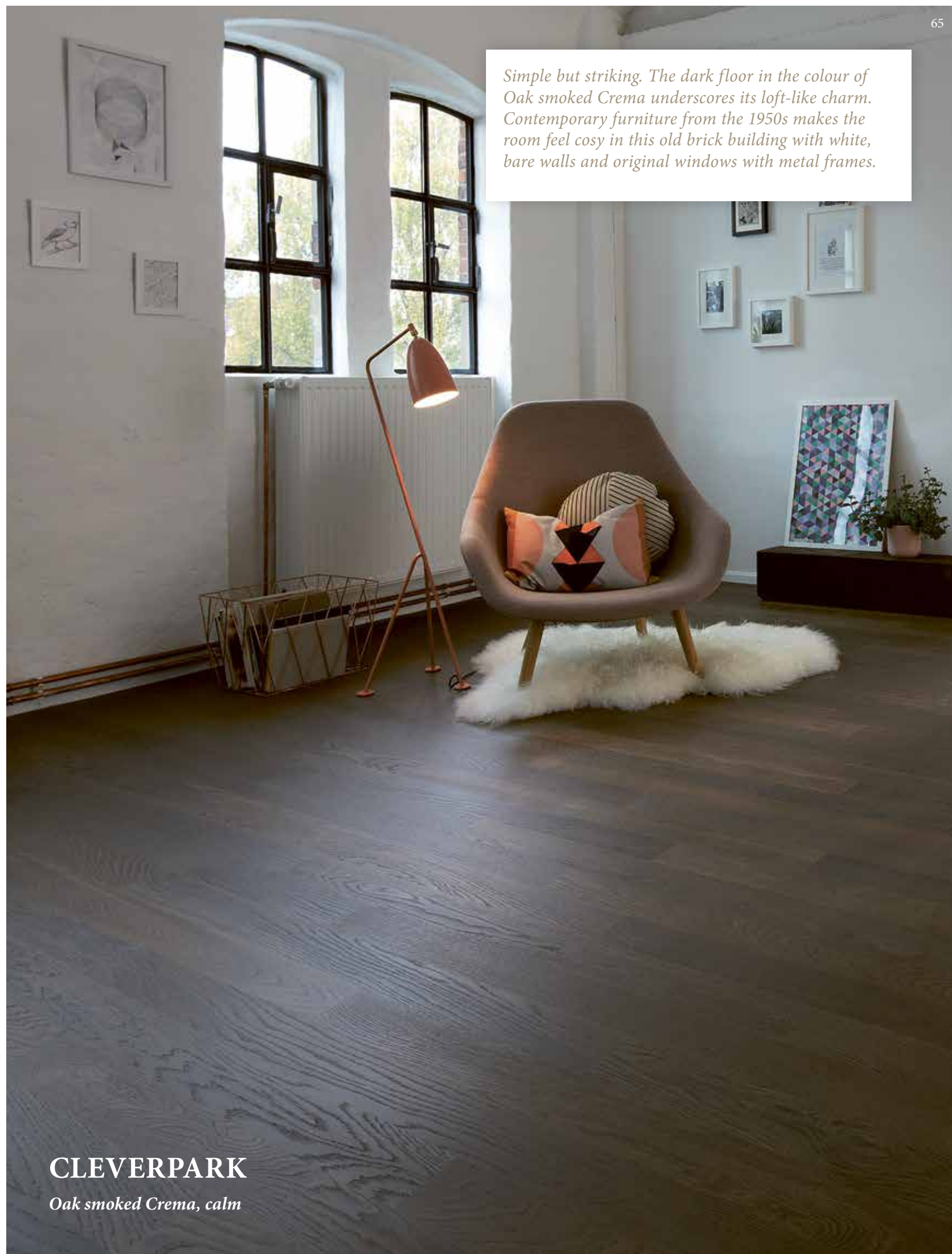

Simple but striking. The dark floor in the colour of Oak smoked Crema underscores its loft-like charm. Contemporary furniture from the 1950s makes the room feel cosy in this old brick building with white, bare walls and original windows with metal frames.

CLEVERPARK

Oak smoked Crema, calm

LYCEUM
ALPINUM
ZUOZ

Product: Cleverpark Silente, Oak Crema
(Special production)
Architects: Architekturbüro renato maurizio ag
Builder: Lyceum Alpinum
Floor installer: Baumann & Co
Photos: Stefan Küng, Löwenzahn Design

Healthy living IN BOARDING SCHOOL

Top quality in education, promotion of eco-awareness, healthy interaction, a well-kept appearance and physical well-being – all of these describe the Lyceum Alpinum private boarding school in Zuoz (Engadin, Switzerland).

The construction of 'Chesa Urezza', a new building to meet academic and boarding needs, was carried out to increase the capacity of the school's campus. In its interiors, the parquet by Bauwerk was selected for its healthy style, ensuring top quality interior spaces and a pleasant ambience. The architect, Reto Maurizio, deliberately adopted the traditional architectural elements of the older buildings for 'Chesa Urezza', reinterpreting their style.

Top-quality with a mountain view

The expansion of the dining room with terrace is also part of the campus extension. The rooms in the new building impress with the high value and quality of the materials used and with the breath-taking view of the imposing mountains and the river Inn meandering through the valley.

Noise reduction for a more concentrated work and living environment

Loud, unwelcome footfalls were an important issue in the bustling rooms of the private boarding school. The silent-padding proved to be helpful with this. This parquet sublayer significantly dampens not only impact sound, but also room noises in general. This is a particularly hot topic in music rooms. If you can effectively reduce echoes, then you can fully develop your sound. Cleverpark Silente has been awarded the 'Cradle to Cradle Gold' certificate, thus fulfilling the ecological requirements of Lyceum Alpinum: this parquet is of controlled origin (Europe) and is part of a continuous material cycle, meaning that it can be reused without hesitation after any dismantling.



Cleverpark Silente bears the 'Cradle to Cradle™ Gold' certificate and thus also fulfils Lyceum Alpinum's ecological requirements.

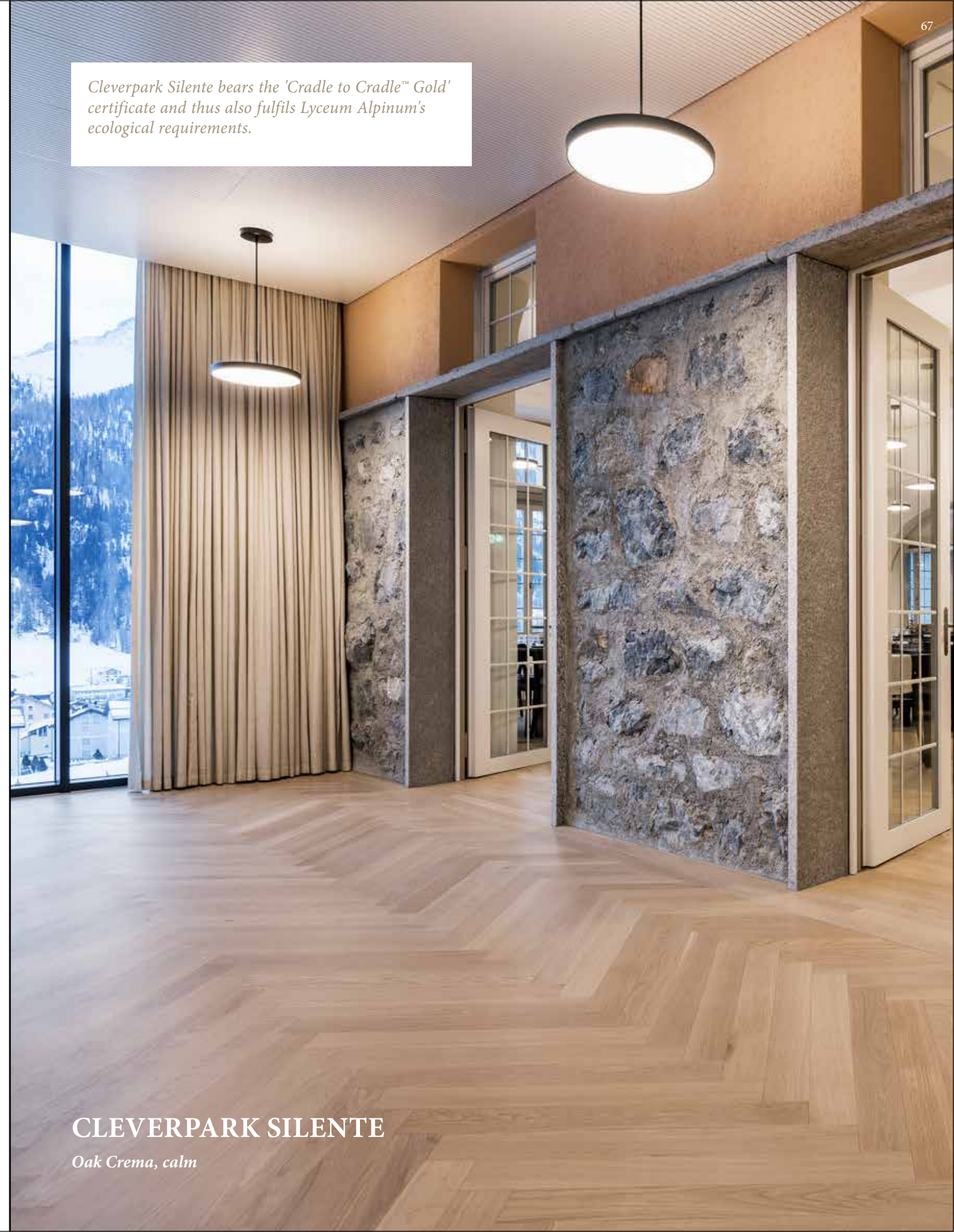

CLEVERPARK SILENTE

Oak Crema, calm

For classical or modern productions

Strip is the traditional parquet classic. With its large variety of colours, surfaces and types of wood, Bauwerk's strip parquet range offers maximum flexibility for impressive room styles, from traditional to modern. And all that high quality comes at a compelling price.

Unopark – the classic for herringbone installation

Unopark is the versatile classic in various colours and surfaces, suitable for installation in herringbone – but also shipdeck-pattern. Whether in oak, maple or acacia, all Unopark products can be installed in the classically elegant herringbone pattern, bestowing a very special ambience to every room. Surfaces in the Used-Look or slightly brushed finish for a pleasant "barefoot feel", offer further possibilities for customisation.

Monopark – the versatile parquet for first-timers

Monopark is manufactured with wood from controlled sources in Europe. Its compact design and excellent value for money make it a truly impressive option. This popular strip, available in three surface treatments, different wood types and a wide range of colours offers so many versatile possibilities, which is particularly great for properties. Monopark is based on HDF technology and has a resource-efficient top layer of approx. 3 mm. Monopark parquet is also available with a cork sublayer for impact sound insulation and is ideal for installing on underfloor heating systems.

Solopark – the classic product for project business

Solopark comes in a classic short-strip format with oak products in various colours. The Solopark-assortment has its focus on project business and offers a compact but attractive colour-range on three surfaces: matt lacquer, natural oil and B-Protect®. The top layer is made from European oak.

Strip parquet is available in the following colours:



Strip parquet Used-Look is available in the following colours:



Unopark – 470 x 70 x 11/12,5 mm
 Solopark – 470 x 70 x 10 mm
 Monopark – 470 x 70 x 9,6 mm

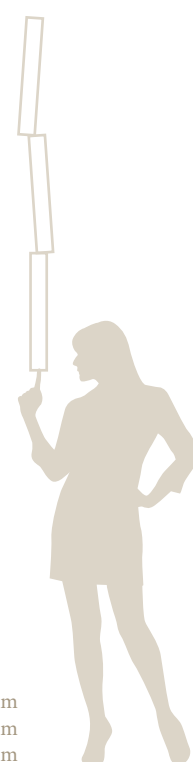

Unopark is a diverse classic with a large selection of colours and wood for practically unlimited use and installation options – whether you choose oak, maple or acacia.

UNOPARK
Oak slightly smoked, lively

Monopark uses HDF technology with a resource-saving top layer of around 3 mm. Monopark parquet floors are also available with a cork underlay for impact-sound insulation, and are ideal for laying on underfloor heating.



MONOPARK

Oak Farina, lively

Monopark is made with wood from controlled sources in Europe and impresses with its compact structure and excellent price-performance ratio.

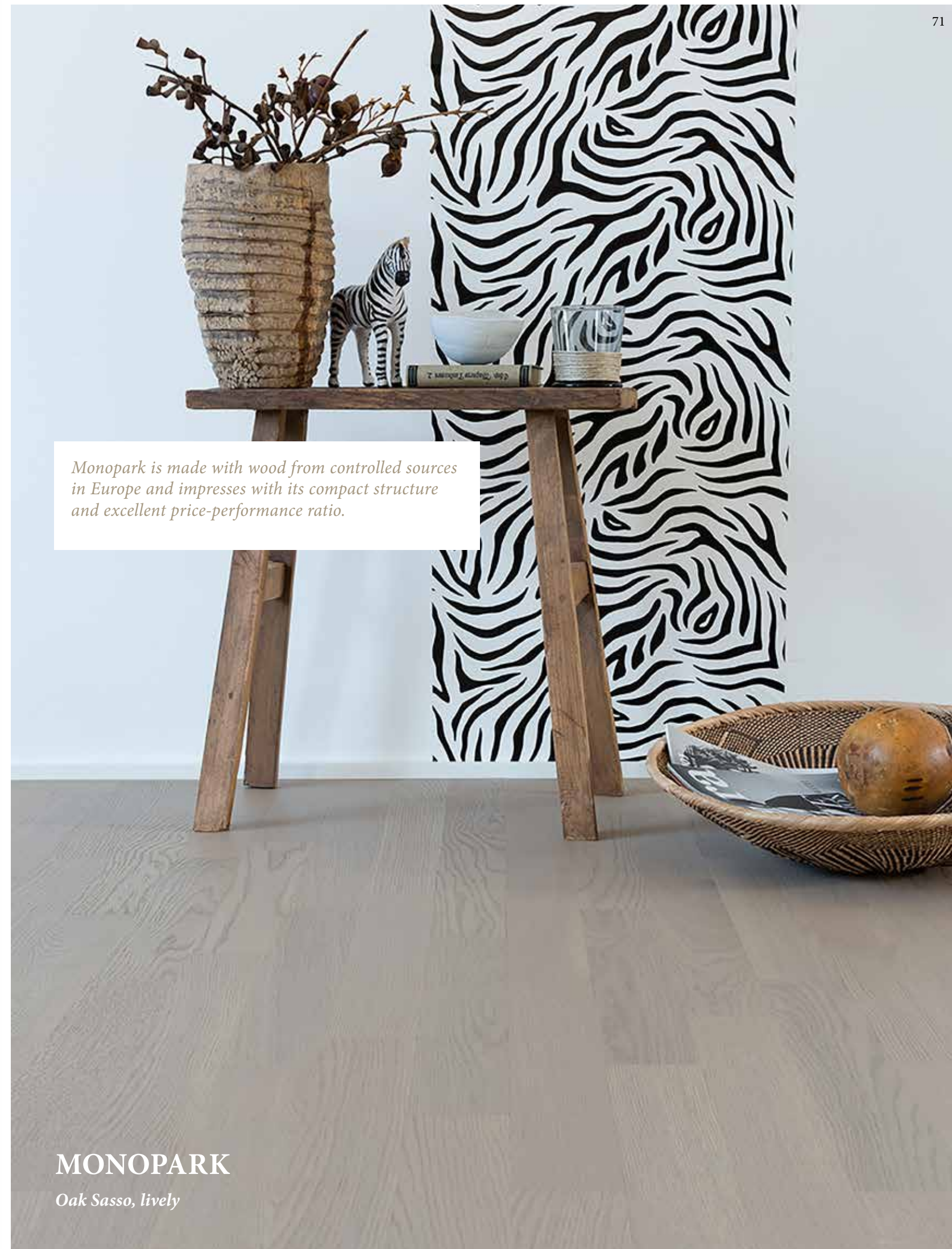

MONOPARK

Oak Sasso, lively

For a timeless industrial look

The history of Bauwerk Parkett began in 1935 with the invention of building-block or mosaic parquet. Its timeless industrial look also comes with high durability and extreme longevity.

Prepark – the practical solid floor

Prepark is a durable, pre-lacquered traditional Bauwerk product that can be used to easily install different patterns. This solid parquet in the classic industrial look is also available with a cork sublayer for improved impact sound values. Prepark is made of wood from a controlled source, it is inexpensive, efficient to install and extremely durable. In addition to this, Prepark is ideal for installing on underfloor heating systems.

Solid parquet – a long-lasting piece of Bauwerk tradition

Even though more than 80 years have passed, the pioneering building block parquet from Bauwerk still prevails. The durable, unfinished Adhesive Parquet in a timeless industrial look is suitable for various installation patterns and is available in numerous gradings. The Adhesive Parquet, with a top layer made from European oak, is 100% FSC® certified, as the name already suggests, it is bonded to the entire area. It is also ideal for installing underfloor heating systems.

On-edge – solid and resilient

On-edge parquet is a classic, extremely durable traditional Bauwerk product in a timeless industrial look. The hardwearing, solid On-edge parquet is 100% FSC® certified and comes in two thicknesses. The top layer is made from European oak, it is supplied unfinished and can be processed with all surface treatments. On-edge parquet is ideal for installing on underfloor heating systems.

Solid parquet is available in the following colours:



Oak

A daring combination: 1950s style furniture in front of newly designed wallpaper. Rich colour contrasts on the building block oak floor make the retro scene look very modern.



PREPARK

Oak Nature, lively, parallel

Shapely in every detail

Design your living space with structure to your liking and ideas. Thanks to versatile accessories and individual special solutions we can guarantee you the perfect solution for any room situation.

Staircase solution - developed and manufactured in Switzerland
Stairs have long ceased to be only the direct path to the upper floor. Rather, they are a detail-rich design element for an optimum spatial effect. The decisive factor is not only the architecture of the staircase and its construction, but also the configuration. Our Swiss-made stair solutions have a decisive advantage: the parquet floor and stairs can have the same colour and surface treatment, as well as the same level of gloss.

Skirting, ventilation grids and custom solutions – design options with parquet

Wood is flexible and invites change, it is the perfect material for personal creativity in living spaces. Create the perfect finish for your room design with matching skirtings and ventilation grids from Bauwerk.

The times of ‘off-the-shelf floors’ are over. Be it ventilation grids, landings, walls or ceilings: with their various elegant solutions and well-designed accessories, Bauwerk products can be used for practically any idea.



Reference: House Au, Formpark, Oak Nature | Photo: Simone Vogel

Stair noses

INNOVATIVE FOLDING TECHNOLOGY

A new and unique production technology makes it possible to fold the stair nose without damaging the surface connection. This creates major advantages: consistency of the surface treatment and the same edge protection as is applied to parquet. All stair solutions are made at our parquet factory in St. Margrethen, Switzerland.

For more information and inspiration, see our "A love for Detail" brochure.

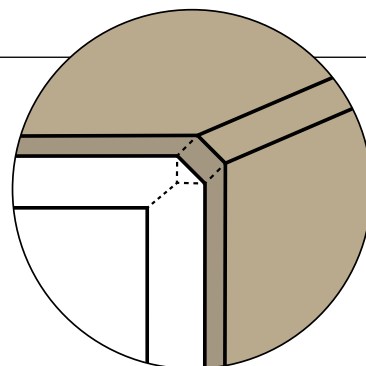

Bauwerk can manufacture matching ventilation grids for your Bauwerk parquet that blend smoothly into the look of your flooring design.

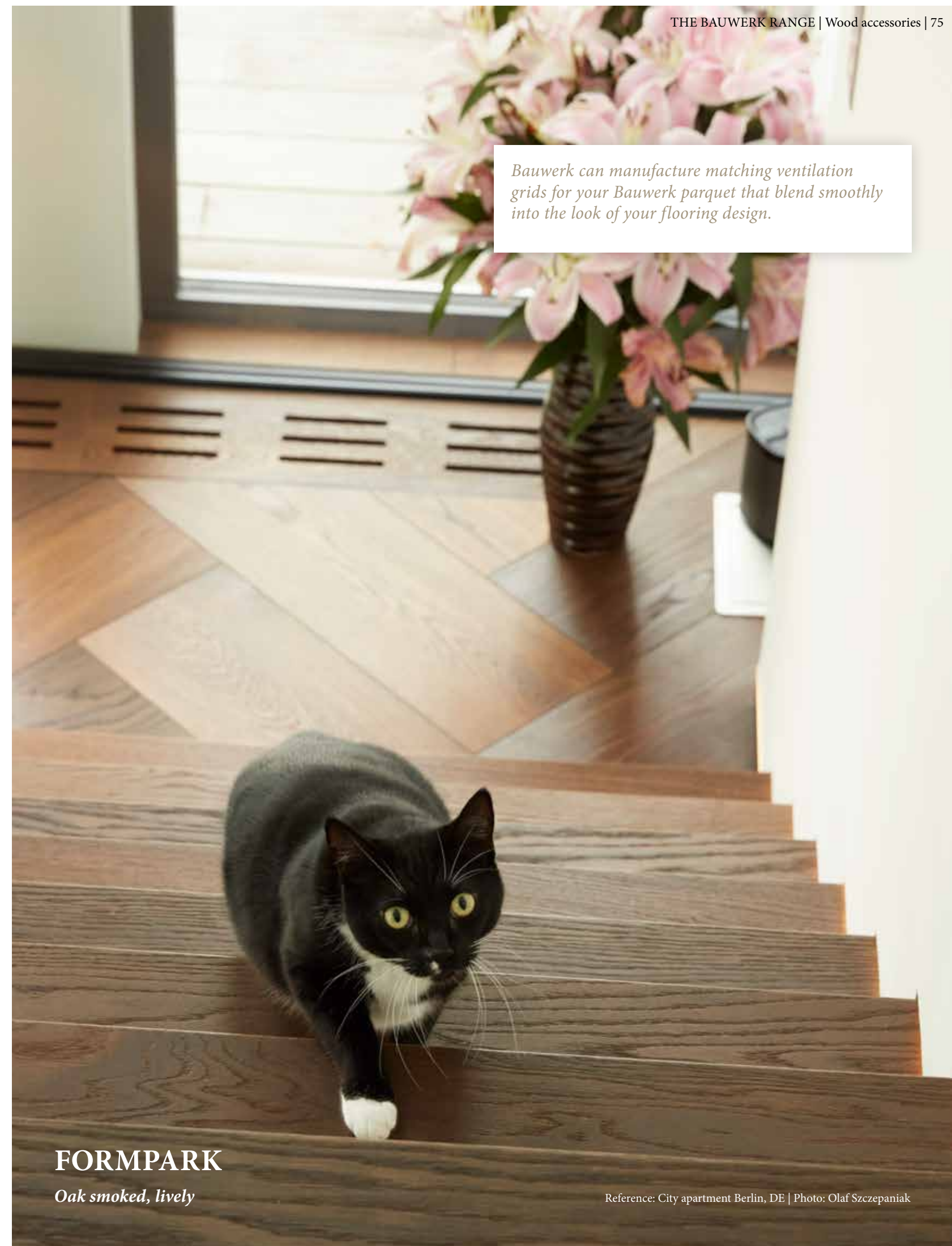

FORMPARK

Oak smoked, lively

Reference: City apartment Berlin, DE | Photo: Olaf Szczepaniak

The right surface for your lifestyle

The Bauwerk range offers products with different surface treatments. They protect wood from wear and dirt, and provide for 100 % healthy living.

Natural-oiled: sensual, natural, easy to renovate

The matte look and authentic feel of this treatment will appeal to all of your senses. The highly durable, breathable surface accentuates the natural appearance of the wood and is very easy to repair. While a natural-oiled floor requires some care, it is worth the effort thanks to its high resistance to soiling.

B-Protect®: authentic, durable, easy-care

This unique surface treatment creates a raw-surface appearance combined with a natural dull-matte look and all the advantages of traditional lacquering. This innovation by Bauwerk provides durability and ease in maintenance. The wood shows minimal discolouration, even with prolonged exposure to light.

Matte lacquered: practical, lasting, functional

This high-quality lacquering adds a silk-matte sheen, highlighting the fine features of the wood and protecting it even under the most demanding conditions. This highly durable and extremely easy-to-care-for surface treatment with resistance to soiling makes a natural floor fit for any living environment.

The character of wood

The art of producing parquet is in achieving the most balanced, reliable grading possible. Wood is a multifaceted natural product, and each strip is unique.

Every tree trunk, every plank and thus every parquet strip is unique. In order to achieve the desired appearance for a parquet floor, Bauwerk classifies individual strips based on wood features in a 'grading index'.

The grading index categorises strips using the numbers 1 to 6. These stand for wood-specific features, such as mirrors (cut medullary rays), small and large branches, sapwood (usually the lighter edge zone of the trunk) and different colour variations. The rule of thumb is: the smaller the number, the smoother the wood – the bigger the number, the more rustic the wood.

12/13 = very calm

14 = calm

15/24/34/25/35 = lively

45/46 = rustic

Quality and longevity

The durability of parquet is not primarily defined by the top layer's thickness; instead, it is determined by structural quality, perfect top layer grip and precise processing.

A quality parquet from Bauwerk dispenses with the unnecessary use of precious wood in the top layer. And it is just as ecologically sensible as it is hard-wearing and durable.



CLEVERPARK

Oak Farina, lively



KNOWLEDGE

Every facet of parquet

The design options for parquet in bathrooms and kitchens, designed to be child and pet-friendly, are almost unlimited. Stairs covered with Bauwerk Parquet fit seamlessly as a harmonious link between floors. Wood carries the power of nature. Wood lives and breathes. Wood is a stylish and conscious decision – for the present, the future and generations to come.

Parquet is changeable and flexible – in all situations...

1 | Huchler Barn
Waiblingen DE, Photos:
David Franck; Product:
Cleverpark Oak Farina;
2 | Schweizerbad CH
(Fraefel AG), Product:
Formpark Mini Oak
smoked; 3 | House Ebnat-
Kappel CH, Photo: Simone
Vogel, Product: Villapark
Oak Avorio; 4 | House
Balgach CH, Photo: Carole
Arbenz, Product: Villapark
Oak Mandorla; 5 | Villa-
park Walnut

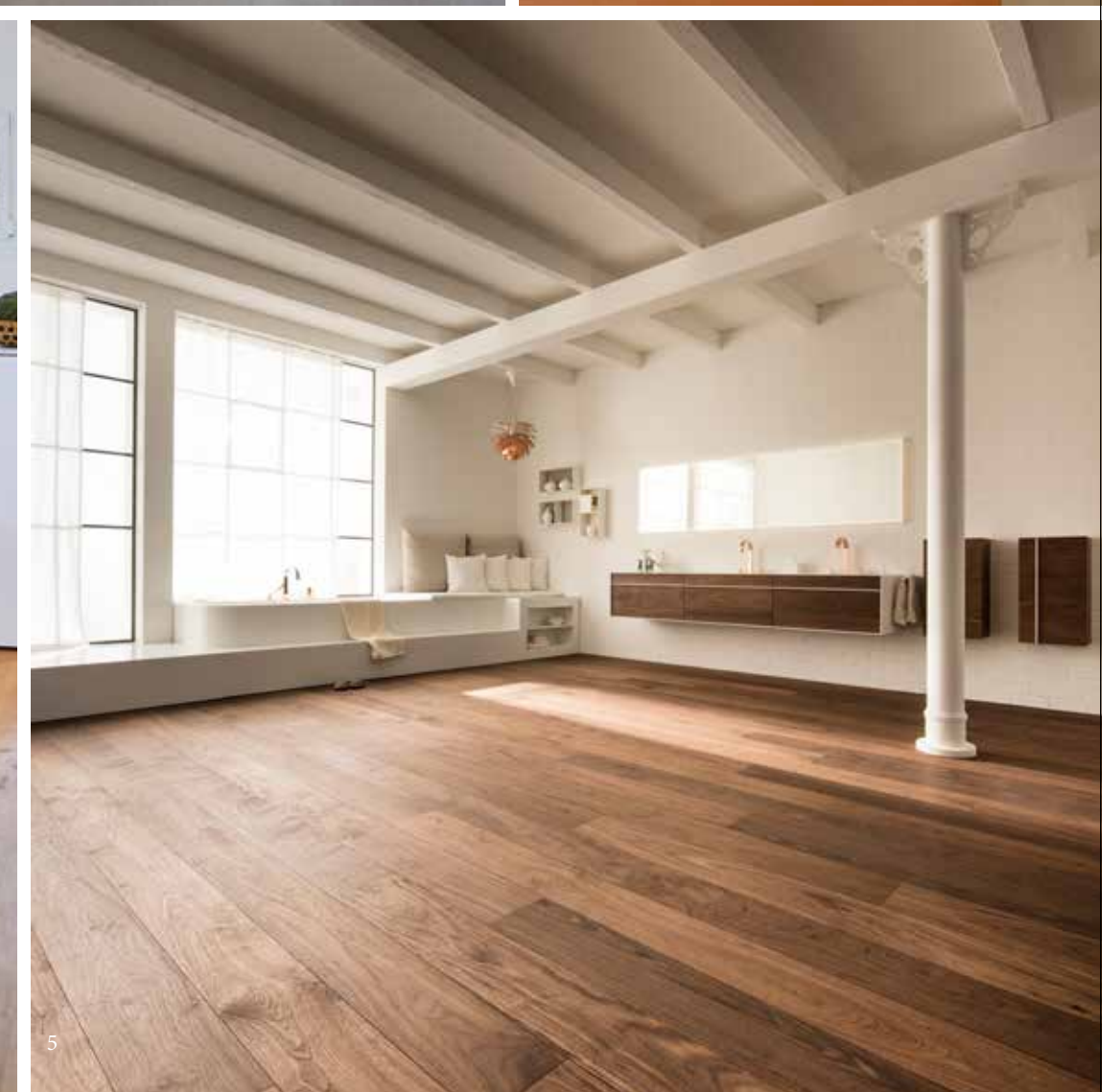
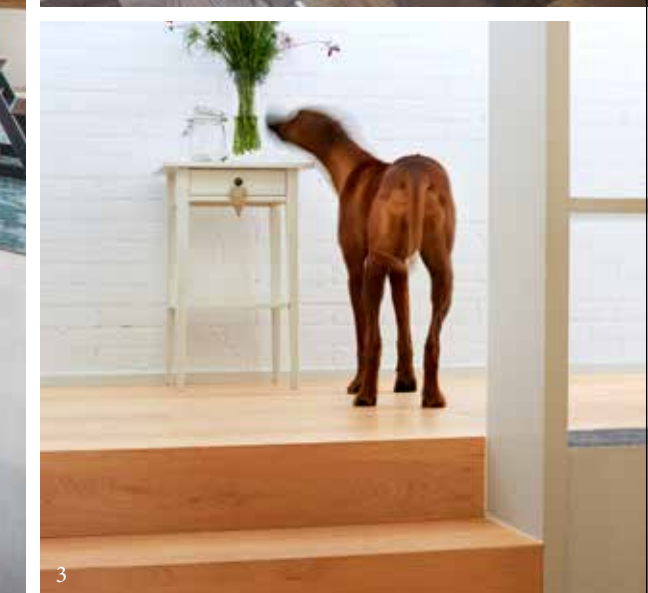

GOOD REASONS

to choose parquet

The wood look is all the rage – no matter whether it is on ceramic, laminate or other floorings. Everyone is busy copying the natural look. Bauwerk's #realwood campaign highlights the countless benefits of parquet: It is timelessly beautiful and always in fashion. It makes our home feel warm as well as being a sustainable material that promotes healthy living. Furthermore, every natural product is unique meaning every home with a parquet floor is unique too!

bauwerk-parkett.com/en/realwood

Every plank, every grain and every piece is unique

The wood's look is dictated by the weather and external influences it is subjected to as it grows. These factors create the unique qualities of every piece, and no two are alike in the whole world.

Sustainability in your home

Because they store carbon dioxide, trees help us everyday in the fight against climate change: 1 m³ of wood saves 1 ton of CO². Plus, wood can be used, reused, recycled and converted into biomass energy. The wood in parquet flooring can also be sanded down several times and refinished to look just like new. That is why parquet is the only truly sustainable floor covering there is.

Adhesives, lacquers and oils are used in the production of parquet. The materials Bauwerk uses meet the highest standards and are regularly tested by independent institutes in different countries. The threshold values are significantly more stringent and thorough than those of the legal requirements, or the quality mark for other floor coverings.

Healthy for your body and soul

We spend 80 to 90 % of our time indoors. Bauwerk parquet floors represent 100 % healthy living. They have a positive effect on the ambient air as they increase the level of humidity of dry indoor air. But by the same token, if the air in the room is too humid, the parquet will absorb some of the humidity.

In addition to the pollutant-free ambient air and the pleasant acoustics, parquet flooring impresses with its other strengths: Parquet floors do not build up static, they feel warm on cold feet and still remain pleasantly cool on hot summer days.

Beauty within your 4 walls

There are all kinds of parquet, from light and calm to dark and full of character, with various surfaces and in lots of formats, not to mention it can be installed in countless different ways: You are guaranteed never to be bored with parquet. The naturalness and authenticity of parquet make it truly beautiful and give every home a cosy, warm feel.

Because we care about people and nature

With the motto of "The symbiosis of man and nature", Bauwerk is dedicated to matters concerning environmental responsibility, healthy living and social ethics. In accordance with the GRI standard for sustainability reporting, Bauwerk Parquet has created a roadmap with initiatives for the years ahead. Specific aims and measurement categories have been defined in the process.

Cradle to Cradle®

WHEN THE CYCLE IS CLOSED



As the first wood flooring manufacturer, Bauwerk boasts the Cradle to Cradle Certified™ Gold for all Silente parquet floors. Moreover, all the products manufactured at the production site of St. Margrethen are Cradle to Cradle™ Bronze certified. Bauwerk has succeeded, as the first company worldwide, to certify all the products from one production site. A process that required five years of hard work and the review of the entire supply and production chain.

I BRING YOU
NATURE
IN ITS PUREST
FORM

#besustainable

EVERYTHING
ABOUT ME IS
REAL

#beoriginal

With its Eco-Institut and Cradle to Cradle Certified™ certification, Bauwerk can assure house builders and their families that all Bauwerk products are 100 % healthy living.

Parquet is taking over OUR HOMES

When we think about parquet, we usually imagine living rooms and bedrooms, where this natural material creates an even stronger sense of comfort. But what about rooms like the kitchen or bathroom? And is parquet suitable for households with children and pets? Be it wet feet after a warm bath, dirty paws coming in from the garden or children turning the living room into a playroom, Bauwerk parquet can handle any situation: easy to care for, durable and robust.

- 1 | Studiopark Oak Crema
- 2 | House Rheinau CH, Photo: Simone Vogel,
Product: Formpark Oak
- 3 | Studiopark Oak smoked



Parquet in kitchens and bathrooms

Given the right preparations and care, parquet can work well in a kitchen or bathroom. Bauwerk's high-quality, full-area bonded parquet with carefully sealed joints prevents moisture from accumulating under the flooring or in cracks. There are also special water-repellent surface treatments available. When applied, parquet by Bauwerk can handle wet feet and small splashes of water.

Parquet in households with families and pets

Mishaps are not uncommon in homes with children and pets, and parquet must be durable enough to withstand them. Because of its robustness and innovative surface treatments, the high-quality and healthy-for-living authentic oak parquet by Bauwerk is well-protected and very forgiving. Cleaning and caring for it is also uncomplicated and extremely easy.



VILLAPARK
Oak Avorio, lively

If the walls and floor are made of real wood, the perceived room temperature is one or two degrees higher than the actual temperature.

SILVERLINE EDITION

Oak Gold

RENOVATION

of and with parquet

Replacing individual planks, grinding the entire surface, or giving the floor a completely new look with surface treatments: all this is possible with parquet.

Refreshing a parquet

First and foremost, an authentic wooden floor stands out with its robustness. But wood also works, breathes, and takes in the stories that life writes into it, making it an unmistakably unique object. However, when it comes to removing signs of wear from over the years, even decades of use, parquet has one decisive advantage compared to other types of flooring: it can be renovated. How successful the renovation will be, largely depends on the structure and composition of the parquet. The thickness of the top layer is not the only factor here: grinding a parquet can be done without any problem only if the parquet was accurately processed and is perfectly attached to its base.

Renovating your floor does not have to involve grinding the wood. Depending on the intended result and the amount of wear, an oiled floor can often take on a new look with the help of various brushing techniques and additional colouring with a different oil. This way, the same parquet floor can survive for several generations and suit various tastes.

Renovation with parquet

Renovation may include more than just parquet as such. During home renovations, parquet can often be laid on top of existing flooring, such as stone or slab, immediately giving the house a cosy atmosphere.

For more information on renovation of and with parquet, visit bauwerk-parkett.com/renovation

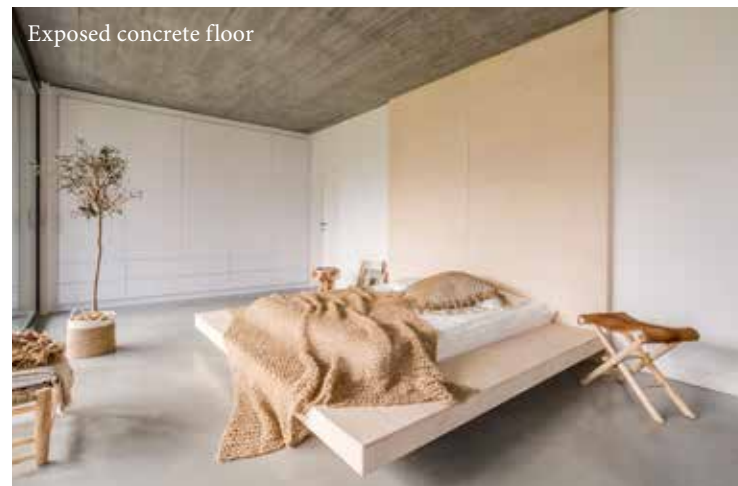

Exposed concrete floor



Parquet

Good to know

- › Normally, about 0.5 to 0.7 mm of the top layer is removed when grinding. Because of this, every floor by Bauwerk can be ground multiple times.
- › Sufficient and regular care extends the life of the flooring.
- › According to ISP (Swiss Parquet Market Interest Group), the expected service life of a parquet floor is up to 40 years.
- › Consult with your floor installer in advance, or contact us directly.



SILVERLINE EDITION

Oak Silver, calm

WOOD LIVES *and breathes*

Colour change due to light source and light incidence

Wood is a natural material that people have used and processed over the ages: Wood lives and breathes and it is unique in its colours, structure and warm surface. When properly processed, its irregularities make it truly beautiful and give every home a cosy, warm feel.

Appearance and use

Oak wood has a grey-yellow to yellow-brown core. The growth rings are clearly visible in the oak and give it a uniform grain. Because of its resistance to moisture and its distinctive aroma, oak is used to produce casks to store wine, whiskey or sherry.

The natural play of colours in wood

Wood is a natural product that slowly develops its natural colour. This happens especially in the early days and it enhances the character of flooring made from real wood. Wood can become darker or lighter with age, or change its shade. The colour tones of smoked wood hardly change at all. Smoked oak only lightens slightly through exposure to sunlight and becomes more golden.

Playing with light

When designing a room, it's worth keeping lighting in mind. The warmth of the light affects both our perception of the floor and our mood. Cool lighting has a refreshing and invigorating effect, while warm light creates a sense of comfort and a cosy atmosphere.

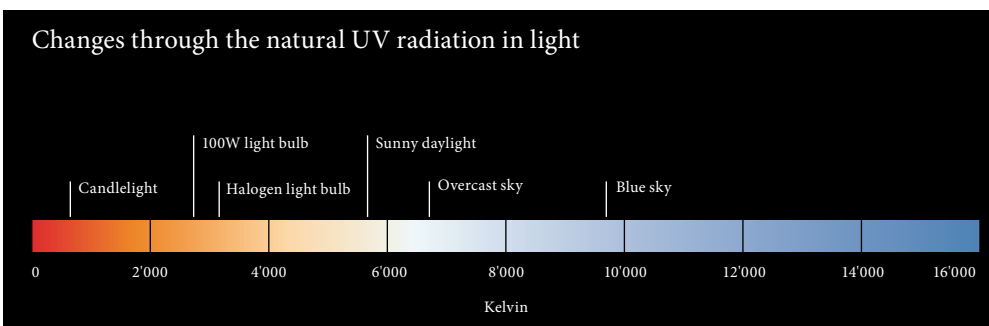

Villapark True Colours Edition,
Oak Canneto



Nuvola is light and heavy at the same time. Like an amorphous cloud, it envelops the room in a bright and gentle embrace, without losing its powerful presence.

VILLAPARK
TRUE COLOURS EDITION

Oak Nuvola, lively

THE WAY of parquet

We have been producing parquet with reliability and precision to meet the highest demands for more than 85 years, and we are proud of our Swiss origins. The path from tree trunk to round timber to finished parquet is long, but well thought out. We value quality in every aspect.

1 ORIGIN OF WOOD

97% of the wood we process comes from Europe, and only 3% from North America (e.g. walnut).

Wood type	Origin
Spruce	Switzerland, Europe
Oak / Oak smoked	Europe
Ash	Europe
Beech	Europe
Acacia steamed	Europe
Walnut American	USA, Europe
Maple Canadian	Canada
Cherry American	USA

7 PROFILING AND FINAL QUALITY CONTROL

Final processing includes profiling and edge treatment: precision is required here so that the planks can be laid together quickly and without difficulty at the construction site. As a final quality inspection, the planks are manually checked and sorted if necessary.

8 STORAGE

The parquet is neatly packaged to protect it against humidity. This way, 63% of the Bauwerk range of products is currently produced at the St. Margrethen site, which is not going to change in the future.

2 SAW MILL

A third of our demand for timber is covered by our own sawmills in Russia, Lithuania and Croatia.

3 KILN DRYING

Since 2017, we have been carrying out raw-material-oriented processing steps, such as kiln drying and cutting of lamellas directly in the growth areas. This way, it is possible for us to usefully create value in the country of origin, causing less environmental pollution thanks to the lower weight of dried wood.

5 GLUING AND PRESSING

The top layer and the base are bonded to each other and compressed.

6 SURFACE PROCESSING

The brushing and coating require a lot of finesse, as every piece of wood is unique. The challenge here is to achieve a consistent gloss level and shade.

4 TOP LAYER PRODUCTION

Nevertheless, our main site in Switzerland is still the focus of any further processing as our brand stands for Swiss quality.

100%
of the wood comes from controlled sources.

97%
of the wood for our parquet production comes from Europe.

63%
of the Bauwerk product range is produced in Switzerland

14
Quality checks are carried out until the product is in stock.



Follow the path of wood from its raw state to high-quality parquet flooring on our Youtube channel "Bauwerk Parkett".

SERVICE

Choosing the right floor

A non-binding consultation, a face-to-face conversation and countless tools accompany you on your way to your dream floor with Bauwerk.

There are various factors to consider when choosing a floor. In the end, however, it's always about warmth, security and a sense of well-being. This is the reason why people feel so comfortable with our parquet. We are more than happy to guide you through this process.

Experience and feel parquet...

FEELING

parquet with all your senses

Inspiration & guidance

Buying parquet involves several decisions. If you are interested in building, rebuilding or expanding a parquet floor, visit one of our numerous Bauwerk Worlds of Parquet.

In an inspiring atmosphere, you will experience a wide variety of parquet floors and innovative consulting tools that combine the interaction of the type of wood and the laying direction with wall colours, living styles and other furnishing materials, such as fabrics, carpets or tiles.

Enjoy a warm welcome and chat with our experienced parquet consultants. They will be happy to answer any of your questions about parquet and your wishes with no strings attached.

All our Worlds of Parquet can be found on page 100.



- 1 | Large sample panels help you visualise the effect parquet will have in your home.
- 2 | With our 'Material Tool', you can not only zoom in on sample panels, but also test how they harmonise with tiles, carpets, fabrics or kitchen surfaces.
- 3 | Bauwerk world of parquet St. Margrethen, Switzerland

WE PROVIDE SERVICE

that's tailored to you



Find your desired parquet flooring online

Wood is timelessly beautiful and fits in any interior design – even in the kitchen or bathroom. When properly cared for, parquet can last for generations and grow even more beautiful. If necessary, it can also be sanded and renewed several times. This means your parquet floor can last you a lifetime.

Bauwerk Parquet offers options for every budget. Calculate the target price for your floor: *Save your favourite parquet flooring on our website using the heart symbol and then calculate the target price for your desired parquet flooring.*

bauwerk-parkett.com/parkettfinder



Just a click away: virtual installation of the parquet of your dreams

Explore more than 200 of our products to find the parquet that best matches you and your lifestyle. Bauwerk's Parquet Visualizer sets up a virtual parquet floor in your own four walls and helps you choose the flooring of your dreams.

Try it out yourself: *visualizer.bauwerk-parkett.com*



10 year warranty – with the Bauwerk ID

Every floor by Bauwerk is a unique piece, an authentic element of your living space, made by Bauwerk to the highest quality standards, carefully selected by you and professionally installed by a specialist. As the durability of our floors is a key quality feature for us, we have created a special Bauwerk ID. Every Bauwerk floor is given a permanent mark to show our understanding of quality and a quality seal, which we use to show the active support we give to you in taking care of your floor. The unique Bauwerk ID can be used to register your floor, and doing so will help ensure you get the best out of it.



Cleaning & Care Workshops: Concentrated expert knowledge

There are a few floors that are easier to maintain than parquet. Cleaning and taking care of the various surfaces of the parquet is extremely easy. Do you have any questions about cleaning and taking care of your parquet floor? There is an expert tip for every situation and every floor – be it lacquered or natural oiled. With these tips, cleaning and taking care of your parquet will become even simpler, and you will enjoy your high-quality Bauwerk Parquet floor for even longer.

For more information, read the 'Cleaning and Care' section of our website and register for one of our workshops.



Find the right cleaning & care products in our online shop

With the right cleaning and care, you will enjoy your parquet for a long time. That's why Bauwerk Parquet offers you various cleaning and care products that are perfectly matched to your parquet floor. The individual surface treatment applied to Bauwerk floors protects the valuable parquet wood from wear and dirt.

shop.bauwerk-parkett.com

Inspiration & guidance

CLOSE TO YOU

Bauwerk worlds of parquet & Showrooms

Competent parquet specialists await you at every Bauwerk World of Parquet in a spacious, inspiring atmosphere. Interactive tools and professional furnishing advice will help you choose the right floor.

SWITZERLAND

Bauwerk World of parquet St. Margrethen

Neudorfstrasse 49, 9430 St. Margrethen

Head office: T +41 71 747 74 74
World of parquet: T +41 71 747 73 30
Parquet forum

Bauwerk World of parquet Chur

Kaserenstrasse 92, 8000 Chur
T 081 254 12 70

Bauwerk World of parquet Genf

Route de Ferney 211, 1218 Le Grand-Saconnex
T 022 788 45 12

Bauwerk World of parquet Wallisellen

Industriestrasse 41c, 8304 Wallisellen
T 044 745 80 80

Bauwerk World of parquet Gümligen

Bahnhofstrasse 2a, 3073 Gümligen
T 031 950 44 88

Bauwerk World of parquet Massagno

Via Battista Foletti 6, 6900 Massagno
T 091 966 62 40

Bauwerk World of parquet Aarau

Aeschbachweg 2, 5000 Aarau
T 062 832 38 20

Bauwerk World of parquet Basel

Münchensteinerstrasse 220, 4053 Basel
T 061 331 88 88

Bauwerk World of parquet Lausanne

Avenue du Mont-d'Or 91, 1007 Lausanne
T 021 706 20 50

GERMANY

World of parquet Bodelshausen

Bahnhofstrasse 77, 72411 Bodelshausen
T +49 7471 700 0

Bauwerk at the stilwerk Berlin

Kantstrasse 17, 10623 Berlin
T +49 30 30 82 78 66

Bauwerk at the stilwerk Düsseldorf

Grünstrasse 15, 40212 Düsseldorf
T +49 211 710 670 74

World of parquet Frankfurt am Main

Light Tower, Hanauer Landstrasse 126 – 128
60314 Frankfurt am Main

Bauwerk at the stilwerk Hamburg

Grosse Elbstrasse 68, 22767 Hamburg
T +49 40 30 03 55 33

World of parquet Munich

Wasserburger Landstrasse 224,
81827 Munich
T +49 89 383 402 44

AUSTRIA

World of parquet Salzburg

Gnigler Straße 61A, 5020 Salzburg
T +43 662 87 38 71 240

World of parquet Vienna

Gonzagagasse 17, 1010 Vienna
T +43 1 21 21 060

FRANCE

World of parquet Paris

29 Quai de la Tournele, 75005 Paris
T +33 1 42 01 57 19

Bauwerk Parquet Viviers du Lac

Savoie Hexapole – Actipole 4
Rue Maurice Herzog, 73420 Viviers du Lac
T +33 4 79 34 17 12

IMPRESSUM

Bauwerk Parkett AG
Neudorfstrasse 49
CH-9430 St. Margrethen
bauwerk-parkett.com

Editor: Bauwerk Parkett AG | Anne Dörte Schmidt
Text: Bauwerk Parkett AG | Pia Kautz
Layout: Bauwerk Parkett AG | Kim Arbenz
Photos: Romain Richard | Simone Vogel | Olaf Szczepaniak | Natalie Bissig |
Claudia Linsi | Frank Schwarzbach | Christine Kocher | Carole Arbenz

Styling: Jeanette Blättler, Zurich | Gesa Hansen, Paris |
Alexandra Rawlinson, Zurich | Miriam Medri, Hamburg |
Sibylle Kaelin, Zurich

FURNISHINGS

Cover image & image page 14, Unicopark Handcrafted Mandorla: ess.tee.tisch by Horgenglarus (Design Jürg Bally 1951) | Floor lamp Arco by Flos | Armchair/sofa by Robert Haussmann RH-302 in mohair cover | Swan Chair (Design Arne Jacobsen 1958)

Image page 17, Unicopark Oak Avorio: Wire Chair by Knoll (Design Harry Bertoina, 1955) | 4 photos black & white by Carole Arbenz | Table (Horgen Glarus) from Bogen 33 Zurich | Console (Design Monica Förster) from Neumarkt 17 Zurich | Vase green by Alfredo Häberli

Image page 19, Unicopark Oak Fumo: Butterfly-Chair by Hardoy | Floor lamp Santa & Cole Tripod G5

Images pages 18 & 19, Unicopark Farina: Basket Chair (Design Gian Franco Legler 1951) | **Gold:** Lounge Chair (Design Charles & Ray Eames 1956) | VK-2 Classic Headphones by Aëdle |

Caffè: Thonet S 33 Cantilever chair | Cyclone side table (Design Isamo Noguchi) | **Oak Nature:** Stool Lou by Tiptoe | Collage by Atelier Patou

Images pages 20 & 21, Villapark True Colours Edition Lava: Night-couch and Coffe Table by Gesa Hansen

Image page 25, Casapark Oak Tabacco Used-Look: Desk Embru Werke AG

Image page 49, Formpark Oak Avorio: Sofa & side table Molteni by Zingg-Lamprech in Zurich

Image page 90, Silverline Edition Silver: Eames House Bird

PRINT

English: 2'500 / 01.2021 / 10144069

Since 2021 our printing products are Cradle to Cradle™ Bronze certified:

Printed on Evolution Blue Nature Cradle to Cradle 120 g/m² for the content and 300 g/m² for the cover.



Highest eco-effectiveness
Cradle to Cradle Certified™
print products by Lokay

*Terra stands for radiant warmth and security.
A floor that welcomes every ray of sunlight, inviting
and pleasantly filling the room with life.*

VILLAPARK
TRUE COLOURS EDITION

Oak slightly smoked Terra lively

In 1935, Ernst Göhner brought the idea of solid parquet to series production before founding Bauwerk Parkett AG in 1944. Since then, Bauwerk has been researching, developing and manufacturing innovative, aesthetic parquet solutions of the highest quality with great passion and Swiss precision. Original parquet floors from Bauwerk, one of the leading parquet manufacturers in Europe, offer the unique feel of a piece of real nature that provides tangible warmth and healthy living for a perfectly balanced atmosphere in any room. *bauwerk-parkett.com*

BAUWERK®
Parquet
