

















Tunnel Greenhouse

Nr	1	2	3	4	5	6	7	8	9	10	11	12	13	14	15	16	
																	
	8pcs	4pcs	4pcs	5pcs	10pcs	2pcs	2pcs	2pcs	20pcs	2pcs	22pcs	1pc	1pc	4pcs	4pcs	1pc	

Loosely assemble the frame, then tightening all bolts in final position.

STEP 1

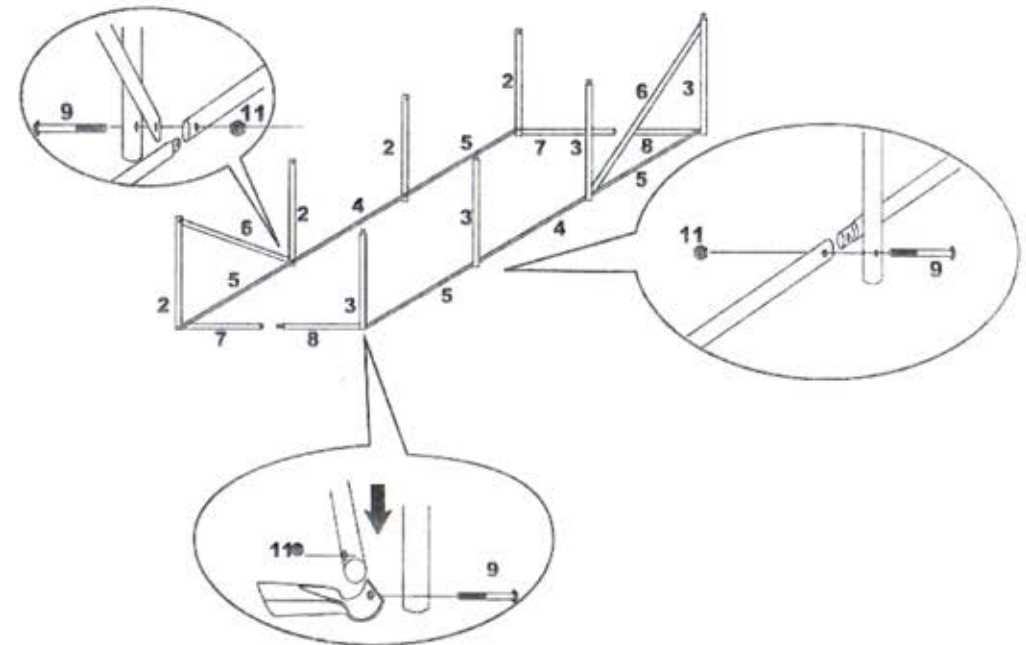

STEP 2

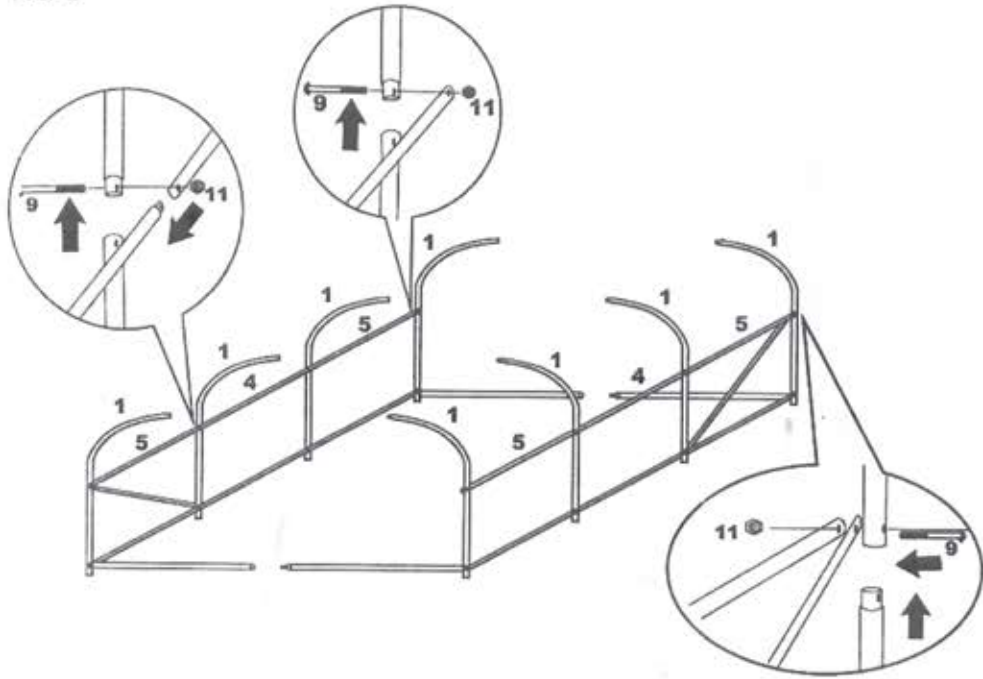

STEP 3

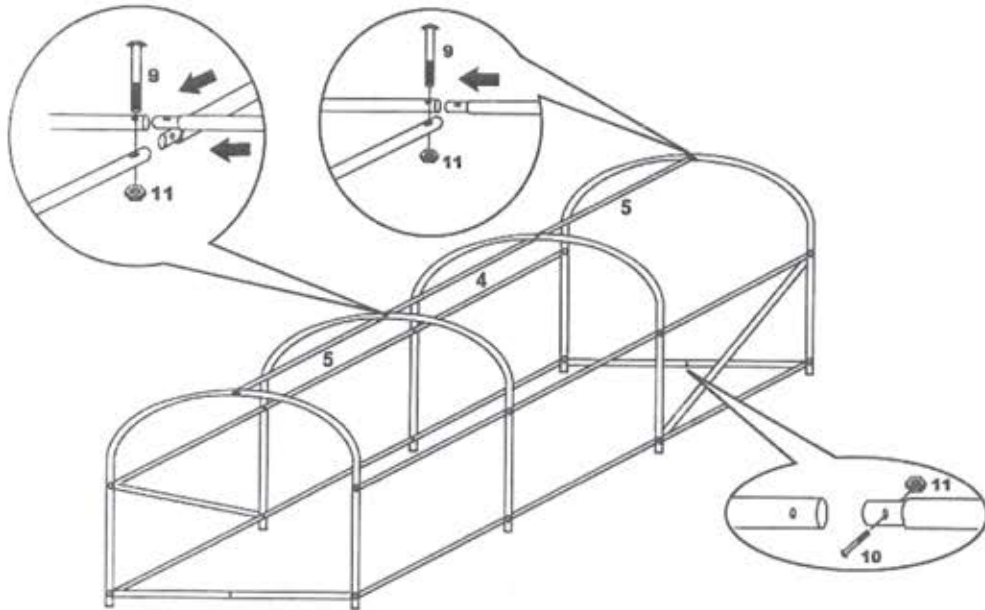

STEP 4

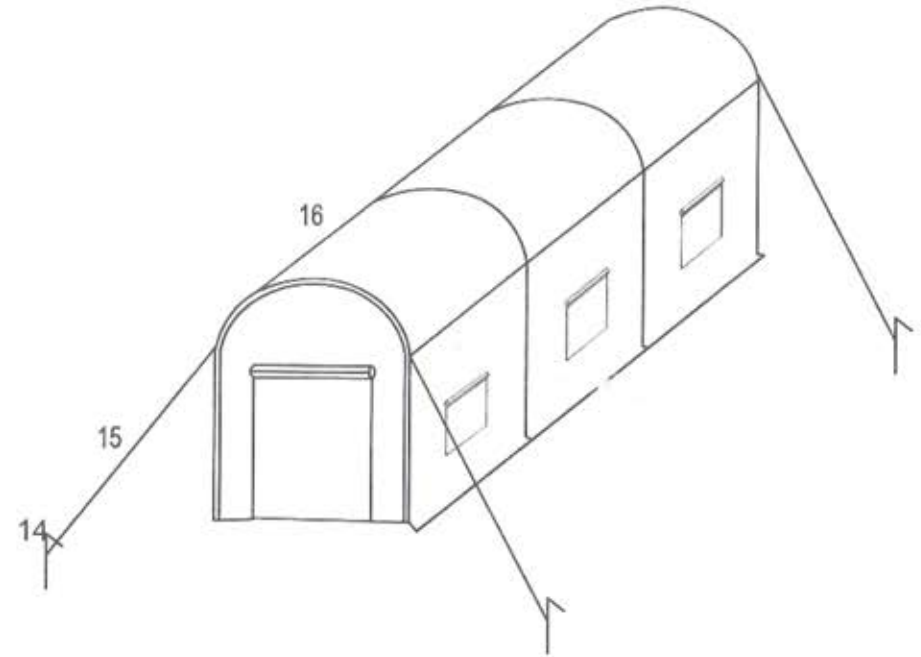

Put the cover on such prepared stellar and mount it with bindings as it was shown above in the picture - parts: 14,15,16.