

# FOLD-OUT BED

## WHAT'S IN THE BOX?

	<b>A</b>	<b>B</b> (Optional)	<b>C</b> (Optional)	<b>D</b> (Optional)
70 cm	<b>16x</b> Bedframe	<b>2x</b> Side	<b>4x</b> Top	
80 cm	<b>16x</b> Bedframe	<b>2x</b> Side	<b>4x</b> Top	
90 cm	<b>16x</b> Bedframe	<b>2x</b> Side	<b>4x</b> Top	
140 cm	<b>32x</b> Bedframe	<b>2x</b> Side	<b>8x</b> Top	<b>2x</b> Connecting piece
160 cm	<b>32x</b> Bedframe	<b>2x</b> Side	<b>8x</b> Top	<b>2x</b> Connecting piece
180 cm	<b>32x</b> Bedframe	<b>2x</b> Side	<b>8x</b> Top	<b>2x</b> Connecting piece

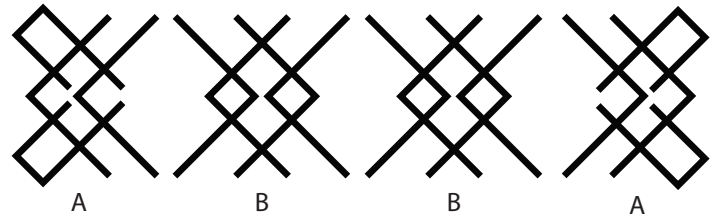
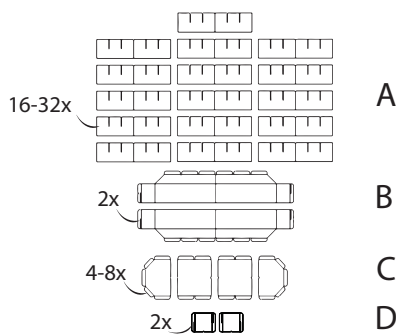
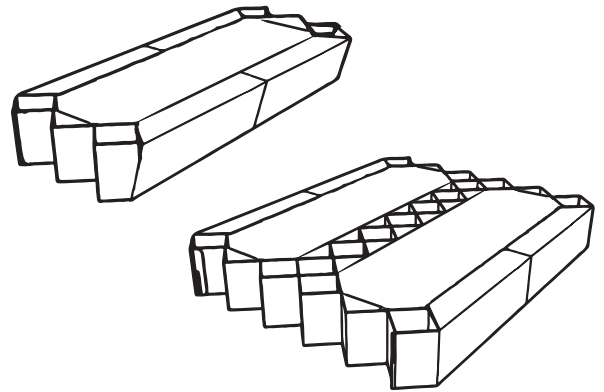

1. Check that you have all the parts. Have. The edge B, top C and the connector D are optional.

2. The frame consists of 4 parts. The front and rear parts (A) are the same, and are connected to the middle parts (B). See image for the overview.

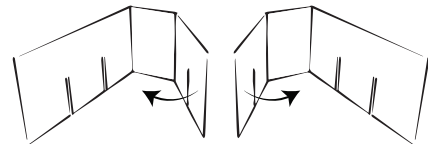
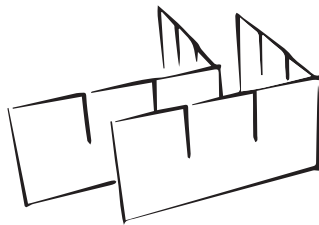

3. Lay out 2 pieces of bed A as shown, with the incisions facing up.

4. Fold 2 pieces mirrored over 1 of the 2 inner incisions. Apply a fold line yourself.

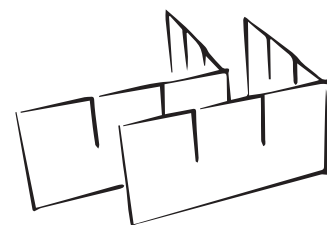
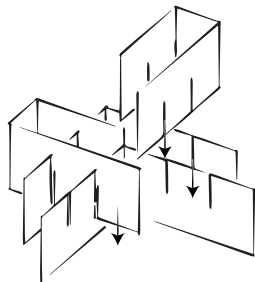

5. Attach the folded parts to the laid out pieces as shown. Part A is now finished.

6. To make part B, lay out 2 bed pieces A as shown, with the incisions facing up.

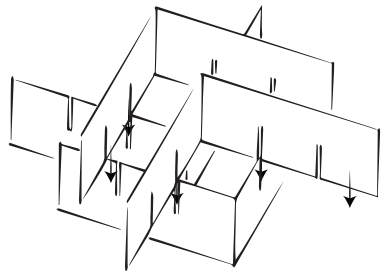

7. Add 2 pieces over the laid out pieces as shown. Part B is now finished.

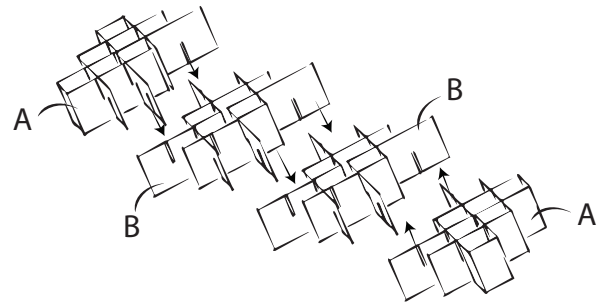

8. Now attach the 2 parts A and the 2 parts B to each other by sliding the slots together.

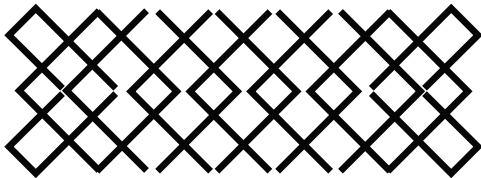

9. The frame should now look something like this from above. If this is incorrect, check that your parts A and B are correct.

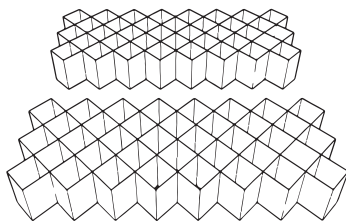

10. **Steps 10 to 13 are only for beds wider than 90cm**  
Repeat steps 1 to 9 and place the 2 beds next to each other.

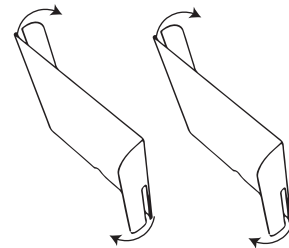

11. Fold the connectors as above.

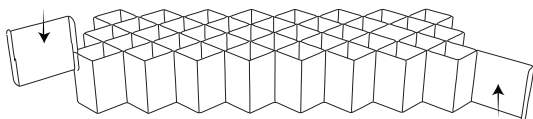

12. Slide the connectors into the rear bunk

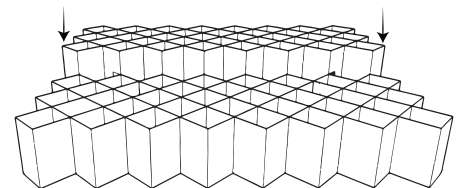

13. Then slide the other bed over the connectors.



2x

14. **Steps 14 to 18 are optional.**  
Fold the flaps of leg B inwards.

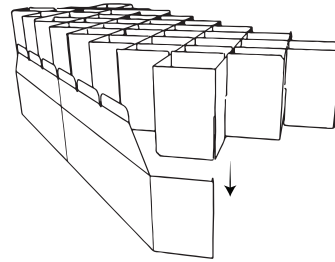

2x

15. Attach the frame to the sides B.  
Make use of the slots. Do this on both sides.

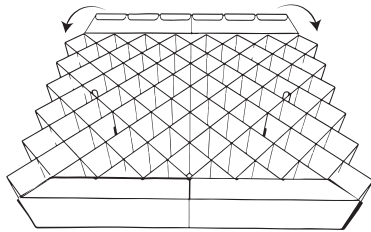

2x

16. Fold the flaps of side B inwards  
and slide into the frame.

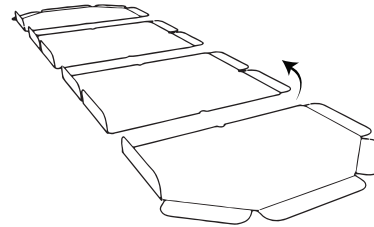

17. Fold the flaps from top of face C  
inwards.

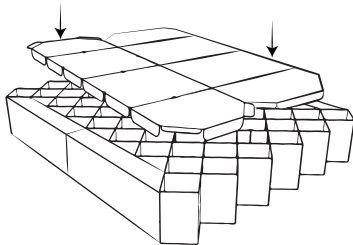

18. Finally, place the top surface C  
on the frame and the fold-out  
bed is finished!