



INFINIX
ELECTRIC FIRES

Electric Fireplace



<http://www.infinixfires.co.uk>
Unit 1 49 Burnbrae Road Linwood
PA3 3BD
Model No: IX1300 PANORAMIC HD
Serial Number: 2023-0905-00049
Rated Voltage: 220-240V
Rated Frequency: 50Hz
Rated power: 2.0KW

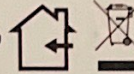

Made in China

Installation and Operation Instructions

INFINIX Fires - 3 Sided Electric Fire

IX750 PANORAMIC HD
IX1000 PANORAMIC HD
IX1100 PANORAMIC HD
IX1250 PANORAMIC HD
IX1300 PANORAMIC HD
IX1400 PANORAMIC HD
IX1500 PANORAMIC HD
IX1600 PANORAMIC HD
IX1800 PANORAMIC HD
IX2000 PANORAMIC HD

TABLE OF CONTENTS

IMPORTANT INFORMATION	2
UNPACKING	3
OPTIONAL SIDE PANELS	4
PRODUCT INFORMATION	5
PRODUCT TECHNICAL INFORMATION	5
PRODUCT DIMENSIONS	5
MANUFACTURERS INFORMATION	5
INSTALLATION AND LOCATION	6
PLACING THE LOGS AND EMBERS	8
OPERATING THE FIRE	9
MANUAL CONTROL	9
REMOTE CONTROL	10
WI-FI / SMART CONTROL	13
USING THE APP.....	17
MAINTENANCE INSTRUCTIONS	18
CLEANING	18
SAFETY FEATURES	18
ENVIRONMENT	19
WARRANTY	20

Please follow the installation instructions carefully and then retain these instructions for future reference.



Please read the instructions carefully **BEFORE** installation.

Important information:

- Keep the front of the fire at least 3 FEET AWAY from combustible materials. These include but are not limited to: articles of clothing, curtains, cushions, furniture, other soft furnishings and papers.
- In order to avoid the product overheating please DO NOT cover the heater.
- Always turn OFF and unplug the heater when it is not in use.
- DO NOT use if the appliance or its cables are damaged.
- NEVER place near bodies of water. These include but are not limited to: bathtubs, fountains, ponds and other water containers.
- NEVER allow any objects to enter or obscure any ventilation or exhaust openings as this may result in an electrical shock, damage to the product or may result in a FIRE.
- A heater contains hot and/or sparking components inside, Therefore, DO NOT use in areas where flammable gases, flammable liquids, paint and petrol are used or stored.
- AVOID the use of extension cables and timers to avoid FIRE.
- This appliance IS NOT freestanding and should not be used as such.
- ALWAYS use properly grounded fused and polarised outlets.
- ALWAYS use ground fault protection where required by electrical codes.
- To AVOID burns and/or personal injury NEVER touch any of the hot surfaces such as the heater vent.
- Power MUST BE DISCONNECTED before any cleaning, relocation or maintenance.
- Any replacement of circuitry or outlets should ONLY be performed by a certified electrician.
- To prevent a potential fire DO NOT attempt to burn any materials in the heater. . These include but are not limited to: marshmallows, paper and wood.
- DO NOT store or keep during transportation, outdoors or in a damp environment.
- NOT TO BE installed below an electrical socket outlet.
- DO NOT leave children unsupervised whilst the appliance is switched on.

Unpacking:

Congratulations on your new electric fire. In order to unpack your product without causing any damage to yourself or the product, please take care and follow the instructions.

1. Place the box on a flat surface. Make sure you have enough space.
2. Remove any rings or bracelets which may scratch the product or be damaged during removal.
3. Carefully remove the appliance from the box and put all packing aside.
4. Please keep the original packing for further storage or transportation.
5. Prior to installation, test the product to check that the appliance is functioning correctly.

Keep plastic bags away from children and animals!

Use this product ONLY as described in this instruction manual. Any other use is discouraged in order to prevent bodily harm and/or fire.

Optional Side Panels

When unpacked the fire has only one pane of glass visible at the front. The two side sections are covered by blanking plates.

If the fire is to be installed as a two or three sided appliance these plates need to be removed. To do this unscrew the fire frame from the body of the fire, remove the panel and then refit the fire frame.

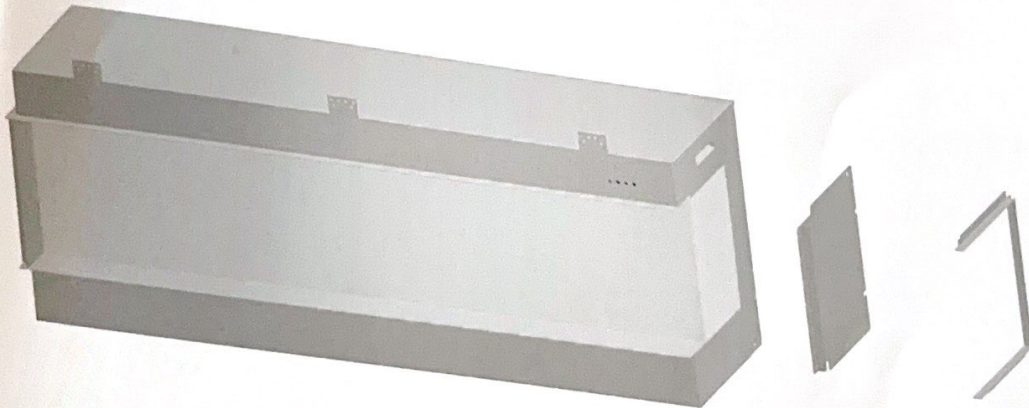

Product information:

Product technical information:

Supplier name	INFINIX Fires
Model number	IX750 PANORAMIC HD IX1000 PANORAMIC HD IX1100 PANORAMIC HD IX1250 PANORAMIC HD IX1300 PANORAMIC HD IX1400 PANORAMIC HD IX1500 PANORAMIC HD IX1600 PANORAMIC HD IX1800 PANORAMIC HD IX2000 PANORAMIC HD
Voltage	220V – 240V AC50HZ
Fuse	13Amp
Nominal heat output	2.0KW
Minimum heat output	1.0KW
Maximum heat output	2.0KW

Product Dimensions:

	Height	Width	Depth
IX-750	617	792	382
IX-1000	617	1042	382
IX-1100	617	1142	382
IX-1250	617	1292	382
IX-1300	617	1342	382
IX-1400	617	1442	382
IX-1500	617	1542	382
IX-1600	617	1642	382
IX-1800	617	1842	382
IX-2000	617	2042	382

Manufacturers' information:

Name	INFINIX Fires
Address	Unit 1 49 Burnbrae Road Linwood PA3 3BD

Installation and location:

Please read the instructions carefully BEFORE installation.

The installation MUST be carried out by a qualified person.

Connect the appliance to a single-phase AC supply of the voltage specified on the ratings plate.

In the instance that the fire is connected directly to the mains electricity supply, a fused switched spur with a 13 amp fuse must be fitted.

- The power supply must be able to handle 2000 watts (2kw).
- This appliance must be earthed
- Do not use an extension lead or a timer.

Always ensure that all electrical work complies with the relevant building regulations and the electrical code of practice.

This product is designed to be either wall mounted and / or fitted and fixed inside a frame. This appliance has multiple electrical components that must be kept away from water and damp or moist conditions.

This product should be fitted to one of the following options:

1. Wall Mounted – Using the H bracket which is located on the back of the appliance. It is important to use fixtures that are appropriate for the type of wall. The wall must be of sound construction and able to hold the weight of the appliance.
2. Mounted on a solid base – Please keep a distance of at least 5 cm from any non-combustible materials.
3. Fitted into a Studded Wall – Which needs to be finished with either plasterboard or a plastered finish. The fire can then be installed with the facing trim of the fire flush up to the plastered finish. See Drawings below:

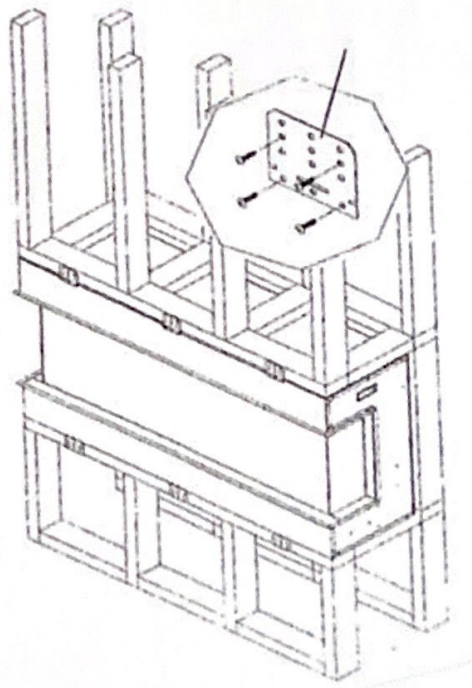

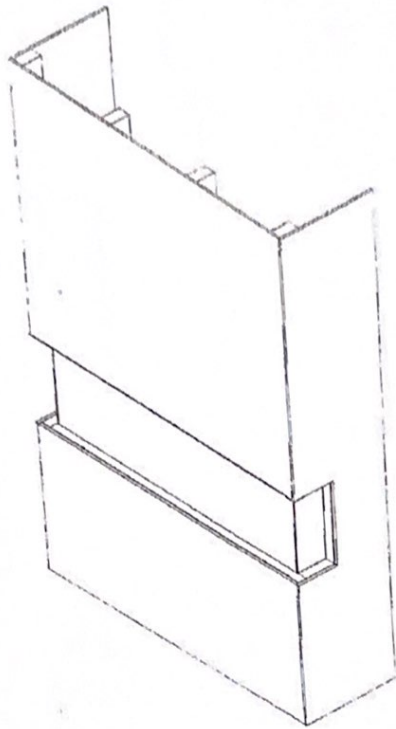

Make sure that the cable is not run across the heater and can be plugged into the mains socket without the use of an extension cable.

Please make sure that the plug socket outlet is in a location that is easily accessible. The appliance should be switched off when not in use and for maintenance.

Placing the logs and embers:

The accessory box which is packed inside the fire contains the mixed black and white nuggets that create the fire bed. These should be placed on the base of the fire in a random manner. The logs are then placed in a position of your choice on top of these. The logs are delicate and should be handled with care.

Operating the fire:

Manual control:



This appliance can be operated manually using the controls situated on the top right hand side of the fire screen.

ON/OFF POWER SWITCH- This switch is used to turn the mains supply to the appliance on or off. When the switch is in the ON position an orange indicator light will show in the middle of the screen. This needs to be in the on position for both manual and remote operation.

STANDBY- Used to switch the appliance ON or OFF into standby mode.

FLAME- Pressing this button will cycle through the four different flame brightness levels.

HEATER- Use this button to select low heat, high heat or heater off.

When low heat is selected the indicator light will glow orange.

When high heat is selected the indicator light will glow red.

Please note that the heater will only operate when the room temperature is below the temperature on the handset, which can be adjusted using the remote or through the app. When the heater switches off the fan will continue to run to cool the appliance.

MODE- Shuffle through a selection of pre-programmed effects.

Remote control:

Remove the battery / completely down as batteries are fitted to the original position disposed of responsibly about recycling

Ensure that the ON position.

Point the remote towards the door down which of remote manual

Setting

button

1

2

Remote control:

Remove the battery / control panel cover by sliding completely down and insert 2 x AAA batteries ensuring the batteries are fitted correctly. Refit the cover by sliding back up to the original position. Please ensure old batteries are disposed of responsibly by contacting your local authority about recycling schemes.

Ensure that the ON / OFF Power Switch on the fire is in the ON position.

Point the remote-control handset directly towards the fire and press the appropriate button to operate the fire. Sliding the door down on the remote control will reveal more buttons which offer additional functions. Otherwise using the basic remote buttons will operate the fire in the same way as the manual control buttons.

Setting the colour functions Press lamp
button:

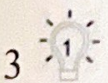
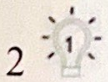

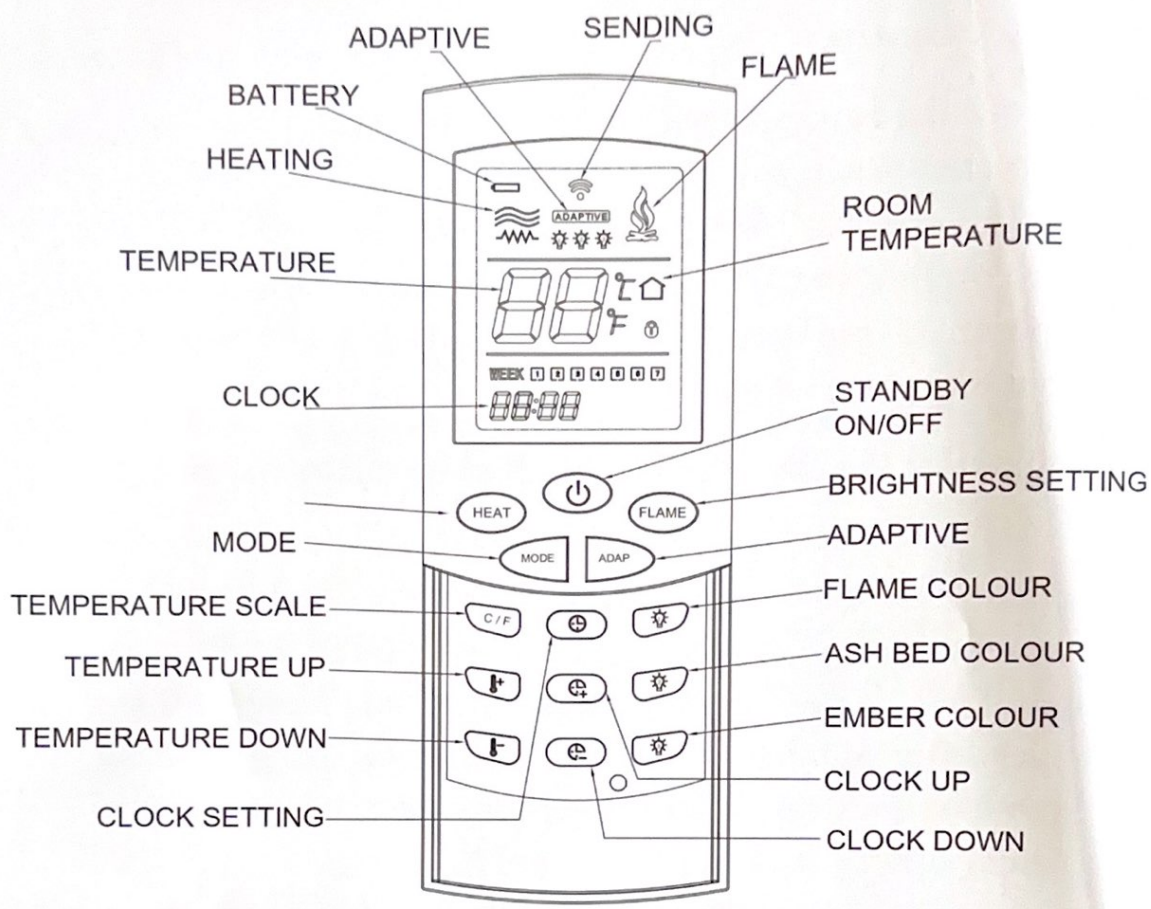

Will change colour of flame, ash bed, ember separately.





Setting the Time:

1. Press the clock setting button, which will start the day cursor to blink. Using clock up and clock down buttons set to the current day e.g. Monday - 1, Tuesday - 2, Wednesday - 3 etc.

Press to confirm the required day.

2. The hour setting will now be blinking, adjust using  and  to the desired hour and confirm using .
3. The minute setting will now be blinking, adjust using clock up and buttons to the desired minutes and confirm using the clock setting button.

Adjusting the desired temperature

Whilst the fire is switched on, use temperature up  and down  to set the desired room temperature.

A confirmation beep will be heard from the fire. If the room is already warmer than the temperature set then the heater will switch off until the thermostatic sensor detects a fall in temperature.

Adaptive Control

Adaptive control works in target temperature 25°C with high heat.

Wi-Fi / Smart control:

Preparation

In order to prepare please check that your mobile phone is connected to your Wi-Fi router. Plug your fire in to the wall. Switch the fire on at the wall socket. **DO NOT** use the STANDBY button to turn on, use the power switch. You should see an orange dot appear on the screen.

The buttons on the fire are as follows:



MODE



HEATER



FLAME



STANDBY



POWER SWITCH

1. Download the 'Smart Life' APP

- The app is free on both Google play and the app store.
- Please search 'Smart Life – Smart Living'.
- Download the app.



2. Open the Smart Life App, Register and Log in

- Open the app and click the register button, unless you have an existing account, then please log in with your existing details.
- Input an email, the app will send a code in order to verify your email.
- Once you have received the code, input the code and create your password.

3. Add your device

- Please touch the 'Add device' button or the 'Add' symbol to add your device.

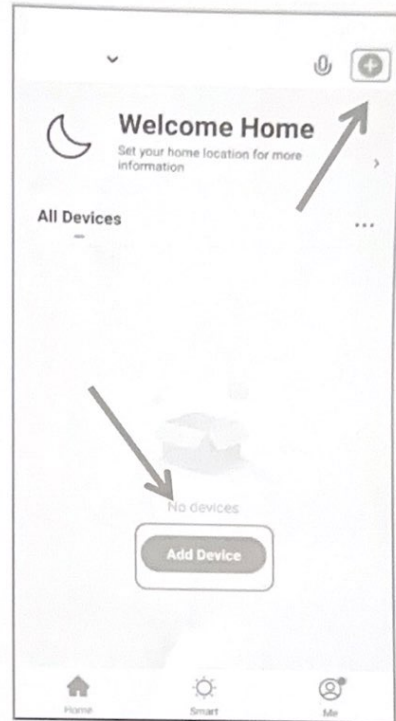

Scan the QR code

- Touch the 'SCAN' symbol.
- Scan the below QR code.

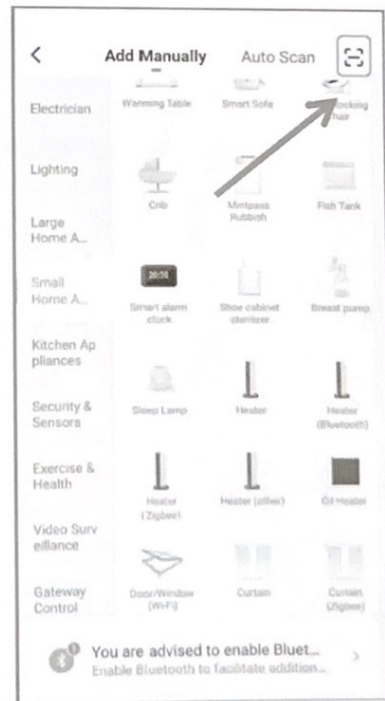

5. Connecting to your Wi-Fi

- Select your Wi-Fi network and input the password of your Wi-Fi network.



6. Establishing a connection

- Give a long press to the standby button for around 3 seconds.

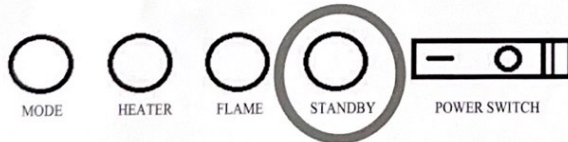

- You should see a red light next to the orange dot in the middle of the fire screen. The red light should be blinking quickly on the screen. Roughly 2 times per second.
- When prompted, if the red light is blinking rapidly, confirm that the indicator is rapidly blinking by checking the circle and then by pressing 'Next'

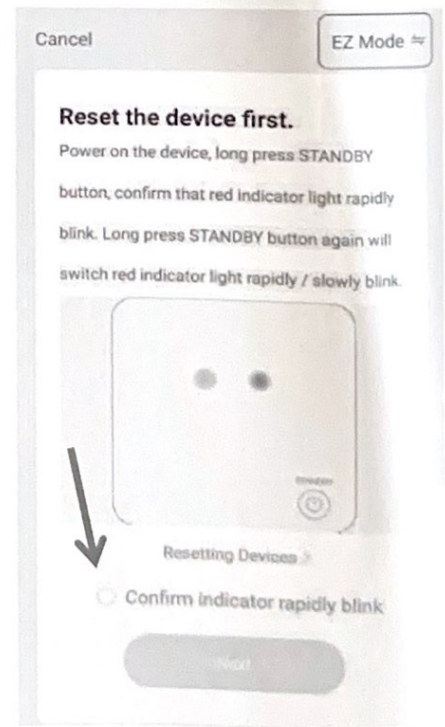

7. Adding your device

- Wait whilst the app adds the device. Please keep the phone close to the device whilst the device is syncing.
- If it fails to sync Repeat steps 4,5 and 6

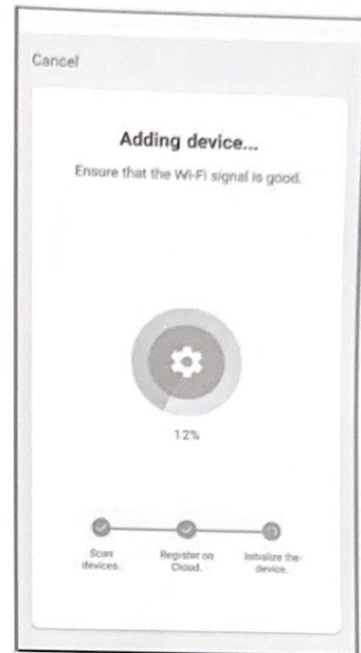

8. Your device has been added successfully.

- Now your device has been successfully added click on the device and you are ready to start using your phone to control your fire.



Using the App



1. To turn the fire on press the standby button at the bottom of the screen

2. To set timers press the clock button at the bottom left of the screen. 7 day timer is available on the APP

The 7 day timer is available within the clock function.



Along the top of the screen there are 5 tabs 'Heat, Flame, Ember, Logs and Mode'

Heat- use this tab to control the temperature.

Flame- use this tab to control the colours of the flames.

Ember- use this tab to control the colours of the embers.

Logs- use this tab to control the colours of the Logs.

Mode- chose one of the preprogramed modes.

For the flame, ember and logs settings you can turn the default Orange colour on / off by clicking the button and can add additional colours by pressing the colour wheel and then selecting your preferred colour from the big wheel above. Both the orange button and the colour wheel button can be pushed on and off.

Maintenance:

You MUST remove the plug from the socket outlet and allow the heater to cool completely before cleaning or maintenance. Maintenance should only be carried out by a qualified person.

Cleaning:

A soft dry cloth, such as microfiber cloths, can be used to remove dust and for general day to day care.

If a more thorough clean is needed a damp cloth, NOT WET, may be used to wash the exterior surfaces. The glass can be cleaned with glass cleaner and a soft cloth.

THE APPLIANCE MUST FULLY DRY BEFORE USING THE HEATER.

Safety features:

As this appliance contains a heating component there is an automatic thermal cut out safety feature. This feature stops the product from overheating and from potentially causing a fire.

If the appliance reaches a temperature above the guideline parameters the automatic thermal cut out safety feature will activate and the heater will cut out. However, the fans will continue to run in order to cool down the appliance.

Once sufficiently cooled the automatic thermal cut out safety feature will automatically reset and the heater will be restarted.

If this problem continues, turn off the fire and disconnect from the plug socket. Check that none of the ventilation vents are obstructed. If

your fire is connected to a chimney, the chimney must be blocked off as the drafts can affect the appliance.

If the problem continues, keep the product unplugged from the power socket and contact your supplier.

WARNING!

- The heater should NEVER be submerged in water.
- The interior should NEVER be wet.
- Cleaning chemicals such as but not limited to detergents, alcohols and abrasives should NOT be used.

Environment:

DO NOT throw out your appliance or its parts as municipal waste. Contact your local government for advice on the collection services and proper protocol in your area.

Please DO NOT dump your appliance as if not properly treated hazardous substances can leak into water supplies effecting animals and people's health and wellbeing.

If you are replacing your old appliance, retailers are legally obligated to dispose of your old appliance without any additional cost.



Warranty:

The online warranty must be filled in on purchasing the product. This will validate your guarantee.

www.infinixfires.co.uk

In the unlikely event that the appliance should prove to be defective due to faulty design, materials or workmanship within 24 months of purchase, the product will be repaired free of charge, In accordance with the following conditions:

The electric fire must have been purchased and used only within the UK and Ireland for domestic purposes and in accordance with this instruction manual.

It is the consumers' responsibility to prove that the unit is under warranty, e.g. receipt of purchase.

All warranties will be null and void if unauthorised repairs or modifications have been made to the appliance, or in case of accident, misuse or damage caused by improper installation, or to damage occurring during transit to or from the repairer and altered or missing serial numbers.

The company shall not be liable for any consequential loss or damage what so ever, arising from or in connection with this electric fire.

This Warranty does not apply to Heating elements, Bulbs or fuses.

'No fault found', service calls and installation errors are not covered under the manufacturer's warranty and will result in a charge being made for the Call-Out by our appointed service engineer.

This warranty is in addition to and does not affect the purchasers' statutory rights of consumers.