

Modules are used to make floor joist framing and installations of deck or composite flooring materials.

BSW60 Product Features

Raw Material	Polypropylene
Height Range	Adjustable min.32mm – max. 250 mm (Optionally, extra 'extension' can be used to increase the height more than 250mm)
Base Diameter	187 mm
Base Wall Thickness	3 mm
Head Diameter	116 mm
Laying Surface of the Base	302 cm ²
Slope Correction	% 0
Environmental Impact Assessment	Eco - Friendly
Application Areas	Can be used for all indoor and outdoor areas. Also, on levelled surfaces, epoxy or membrane insulated in areas.
Application	Using any of fixing material is not necessary. Optionally, the modules can be fixed to the application surface using adhesive or screw.

BSW60 Technical Drawing

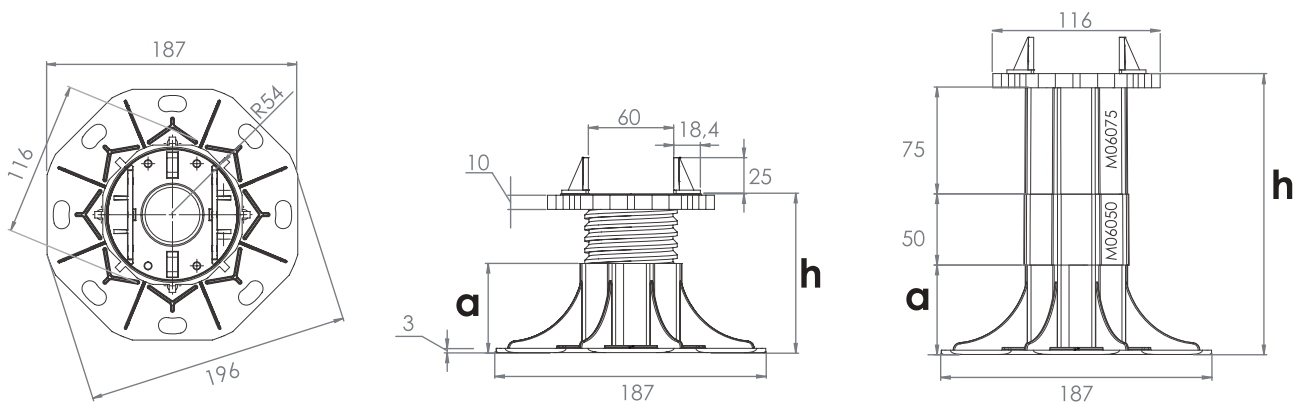

BSW60 Dimension & Weight

Model	BSW60-01	BSW60-02	BSW60-03	BSW60-04	BSW60-05	BSW60-06	BSW60-07	BSW60-08	BSW60-09	BSW60-10
a	18 mm	27 mm	40 mm	62 mm	40 mm	62 mm	62 mm	62 mm	62 mm	62 mm
h (min. - max)	32-38 mm	38-50 mm	50-75 mm	73-110 mm	102-130 mm	126-155 mm	147-184 mm	175-205 mm	200-225 mm	220-250 mm
Extension	-	-	-	-	M06050	M06050	M06075	M06050	M06050 M06075	M06075
Weight	0,170 kg	0,181 kg	0,198 kg	0,232 kg	-	-	-	-	-	-
Comp.					+ 	+ 	+ 	+ 	+ + 	+

BSW60 Pressure Resistance

Pressure measuring point

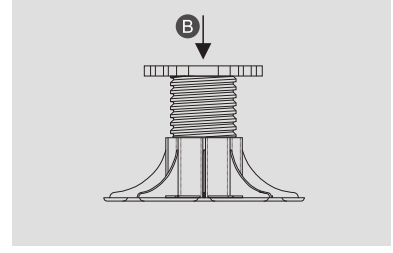
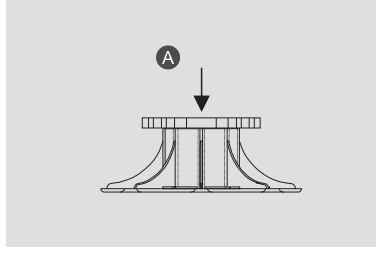

A Minimum highness

COMPRESSION TEST (HOT 23°)

B Maximum highness

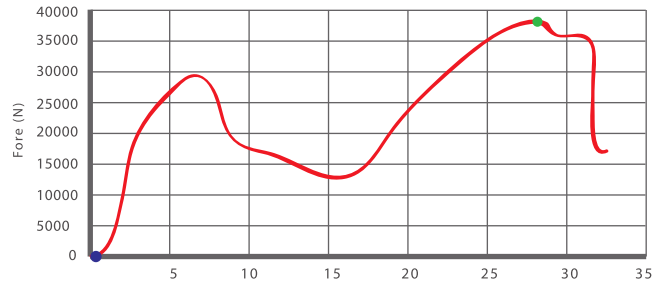
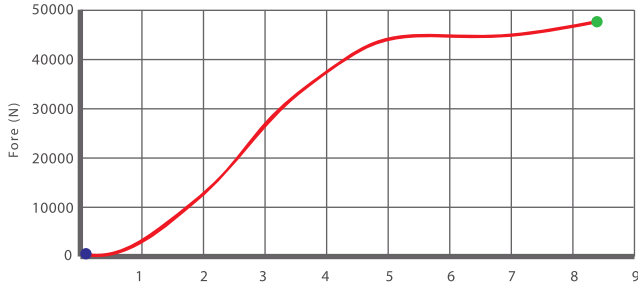

A Minimum highness

COMPRESSION TEST (COLD -40°)

B Maximum highness

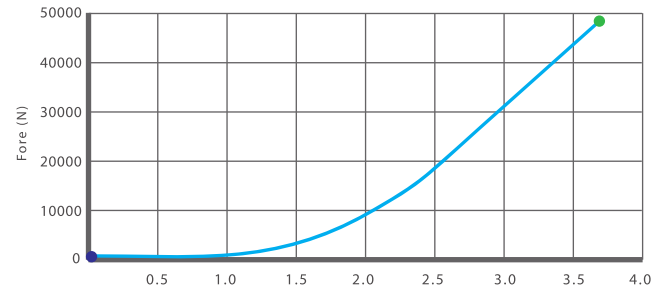
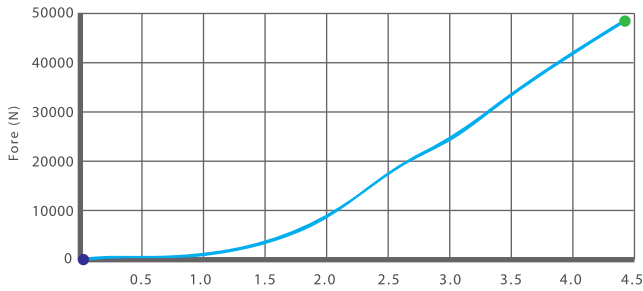

TESTED AND APPROVED BY HEADSHIP OF TURKISH STANDARDS INSTITUTION (TSE) AND CALIBRATION CENTER CONSTRUCTION MATERIALS LABORATORY (ANKARA CITY)

BSW60 Packaging Information

Product code	BSW60-01	BSW60-02	BSW60-03	BSW60-04	M06050	M06075
Pcs per box	80*	70*	50*	40*	60***	40***
Gross weight per box	13,35 kg	13,70 kg	11,70 kg	11,00 kg	5,40 kg	4,00 kg
Boxes per pallet	12	12	12	12	48	48
Box dimensions	60cm x 40cm [*] x h=40cm		40cm x 30cm ^{**} x h=41cm		40cm x 30cm ^{***} x h=20cm	
Gross weight per pallet	185 kg	189 kg	165 kg	157 kg	285 kg	217 kg
Pallet dimensions	cm 80 x 120 x h140					

* Products are packed in cardboard boxes. Shrink-wrapped euro-pallets are used for final packaging. In spite of being shrink-wrapped and rain proof packagings, recommended to keep the pallets in closed area.

* The technical data products above indicate the current production. It may be updated or modified at any time without prior notice by Öztürk Plastik Kalıp San. Tic. Ltd. Şti..

* We do not take any responsibility for any problem which caused misuse of the products.