



ROOF SAFETY SYSTEMS BV
BY DROSTE BEJAH

WORK SAFE SAVE TIME

Roof Safety Systems bv | Asjeskampweg 4 | 7772 AZ Hardenberg
The Netherlands | info@rss-roof.com
www.rss-roof.com



USER INSTRUCTIONS

RSS Roof Edge Protection System according EN 13374 +A1 2019 Class C



Sloping Roof

Page1 - 10



A

Goal of the RSS system



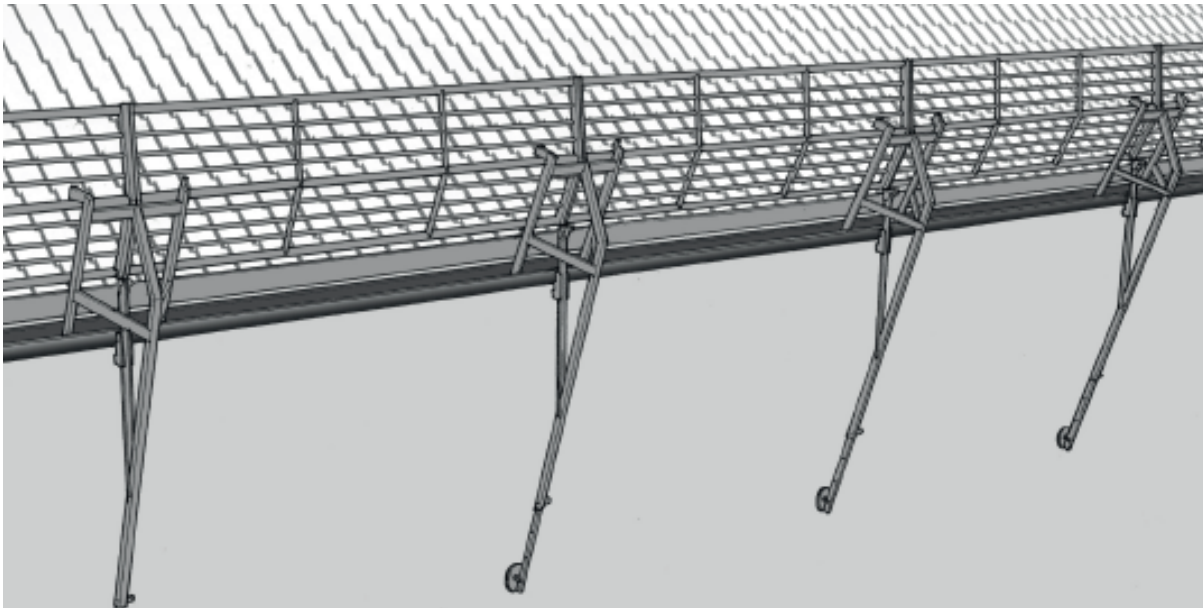

Under local and European regulations, it is in most cases obliged by law that roof edges must be guarded to prevent falls when working on a roof. The RSS system is designed to realize effective group fall protection on flat and sloping roofs.

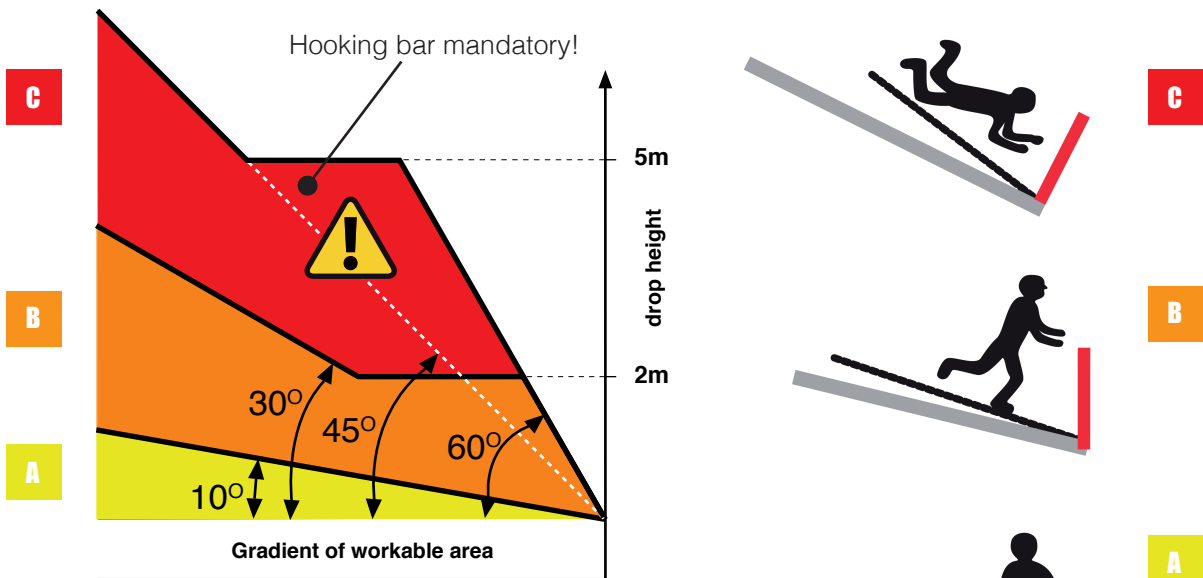

The RSS system is used with a fence 3 metres in length. If installed according to these instructions, it is suitable as temporary edge protection as described in EN 13374 +A1 2019 Class C for roof gradients of up to 60 degrees as long as the fall height is no more than 5 metres. In Class C situations (see drawing) **the hooking bar** is mandatory.



In this situation, the system may only be used if the 'General conditions of use' are met, see **E**.



Hooking bar	Class	Mandatory	Advice
	C		
	B	—	
	A	—	

B**Components of the RSS System**

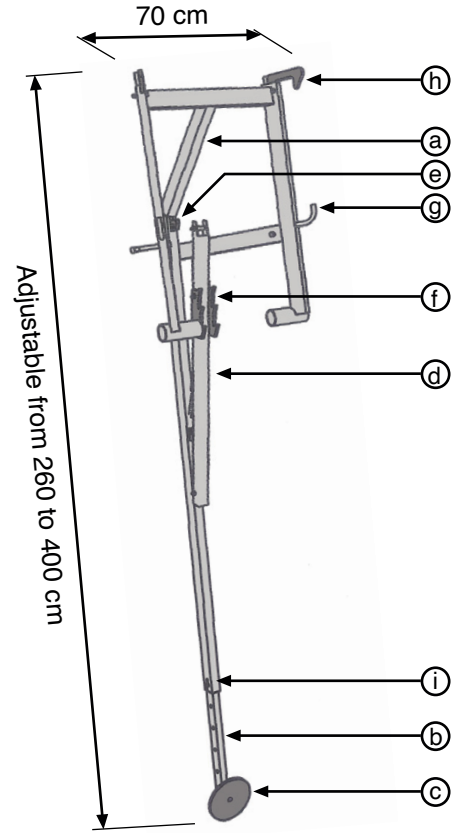
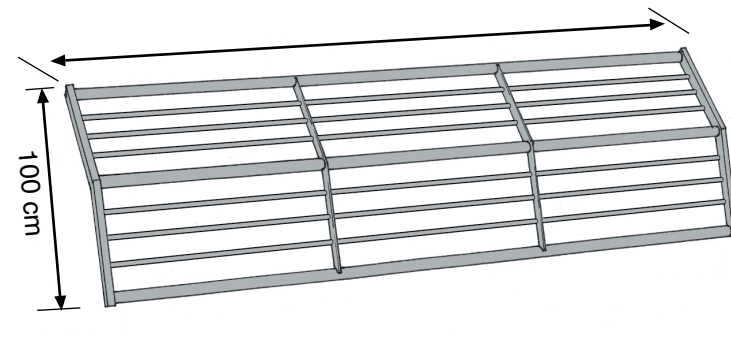
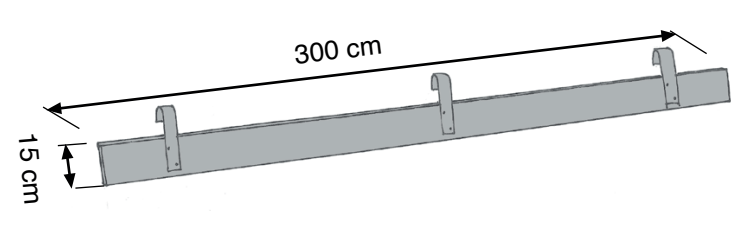
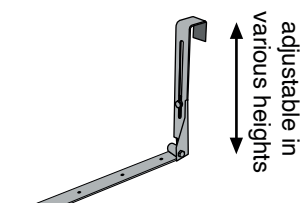
The RSS system consists of 3 components:

	<p>1) Stanchion</p> <ul style="list-style-type: none"> a Main tube b Adjusting tube c Foot d Arm e Lock f Blocking device (against lifting out) g Fencing hoop h Fencing lock i Adjusting tube pin <p>Total weight: 10,6 kg</p>	<p>Partnumber 101-EU</p>
	<p>2) Fence</p> <p>3 meters: suitable up to and including class C</p> <p>Total weight: 12,3 kg</p>	<p>Partnumber 102</p>
	<p>3) Toeboard</p> <p>Length: 3 meters</p> <p>Total weight: 4,5 kg</p> <p>Attention: Mounting the toeboard is mandatory (belongs to the system)</p>	<p>Partnumber 103</p>
	<p>4) Hooking bar </p> <p>Mandatory if the edge protection is used in Class C situations. (see drawing, page 1).</p> <p>Total weight: 1,5 kg</p>	<p>Partnumber 104</p>

C

Sloping Roof

EN 13374 +A1 2019 Temporary Edge Protection Systems Class A, B and C

class	static load [kN].			dynamic load [kN].			
	Fh1	Fh2	Fv	Roof Inclination	Fh1	Fh2	Fv
A	0.5	0.2	1.5		not applicable		
B	0.7	0.4	1.5	10°	5.0	1.0	1.2
	0.7	0.4	1.5	30°	4.4	1.0	2.8
	0.7	0.4	1.5	45°	3.6	1.0	3.8
	0.7	0.4	1.5	60°	2.6	1.0	4.6
C	not applicable			30° - 60°	6.5	1.0	5.1



**Class A, B and C
EN 13374 +A1 2019**

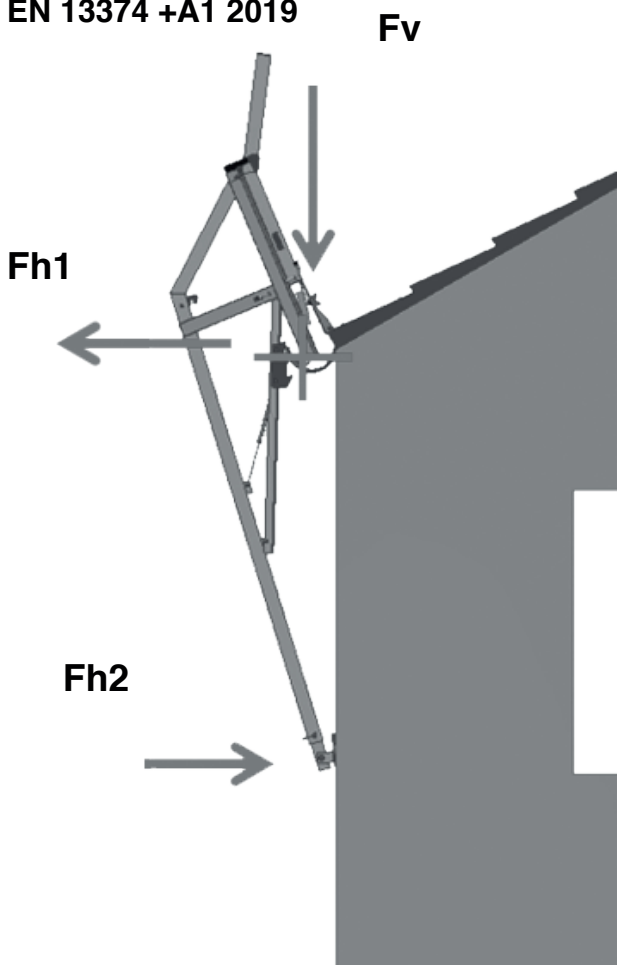

Calculation of starting points for dynamic loads Class C

- 1) One stanchion takes the full load
- 2) The energy absorption distance on the stanchion is 120 mm
- 3) The gutter is calculated as a fixed and rigid object
- 4) The impulse load is 0.03 seconds

Fh1 Horizontal reaction force on the gutter

Fh2 Horizontal reaction force of arm on the wall

Fv Vertical reaction force on the gutter

The static requirements can be confirmed by means of calculation. In practice, this is done e.g. by connecting a rope to the gutter and simulating the forces specified in the table.

The dynamic requirements must be confirmed by **testing**.

D**Installing and Dismantling**

The RSS system offers collective fall protection.

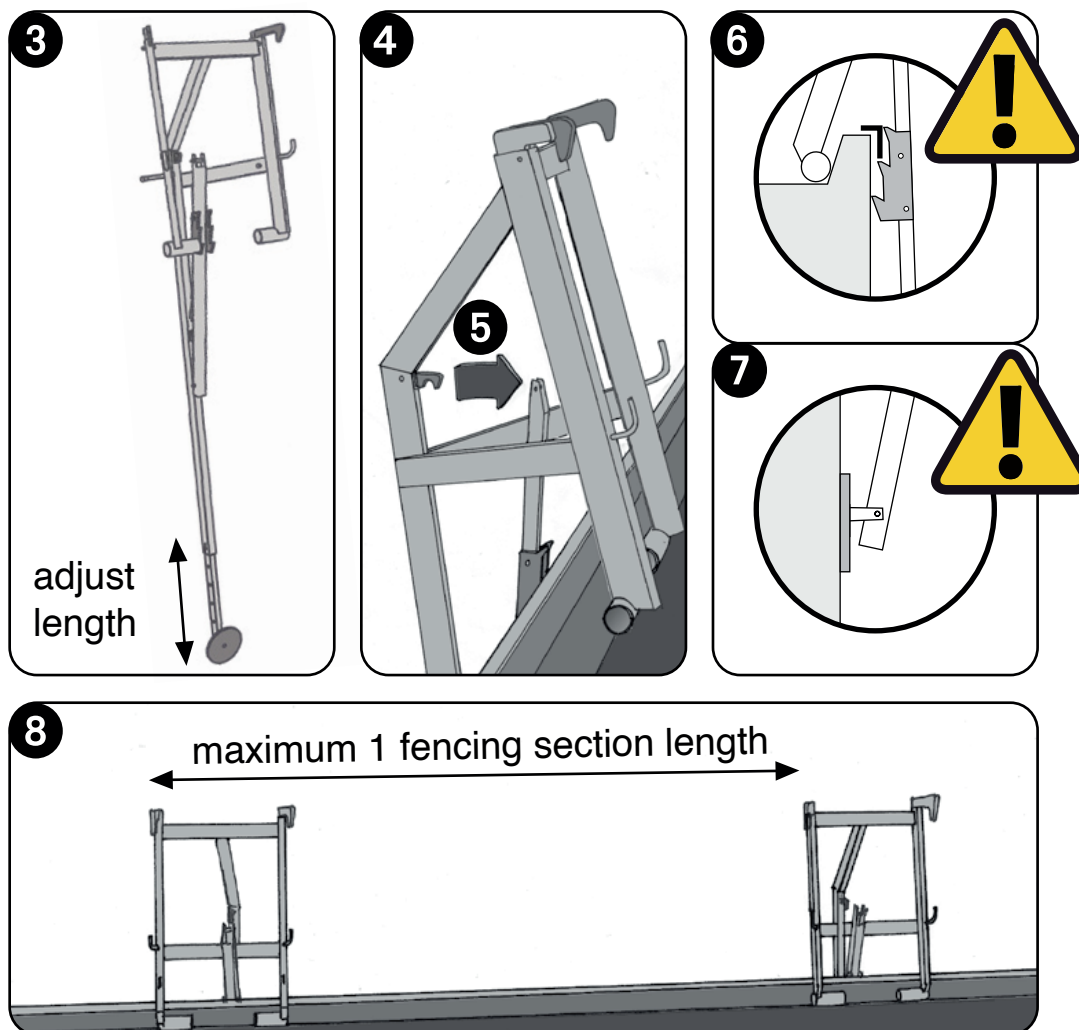

USE INDIVIDUAL PROTECTION WHEN INSTALLING, DISMANTLING OR MOVING THE RSS SYSTEM!

**Inspection**

- 1 Inspect the situation for suitability (see page E 'General conditions of use').
- 2 When installing and dismantling, check all components for any defects.

Placing stanchion

- 3 Set the adjusting tube of the stanchion to length so that the foot can be supported on a sufficiently strong part of the façade.
- 4 Place the stanchion behind the edge of the roof or in the gutter.
- 5 Unlock the arm so that it moves towards the roof edge or gutter.
- 6 Check that the stanchion is blocked against lifting out the gutter by the blocking hook, see E 'General conditions of use'.
- 7 Check that the foot is lying flat against a sufficiently strong part of the façade (see E 'General conditions of use').
- 8 Place the next stanchion (maximum of 1 fencing section length beside other stanchion).



USE INDIVIDUAL PROTECTION WHEN INSTALLING, DISMANTLING OR MOVING THE RSS SYSTEM!

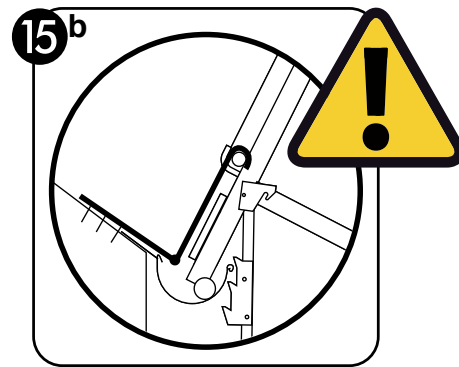
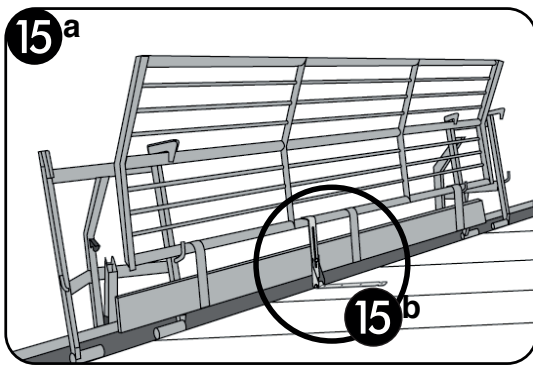
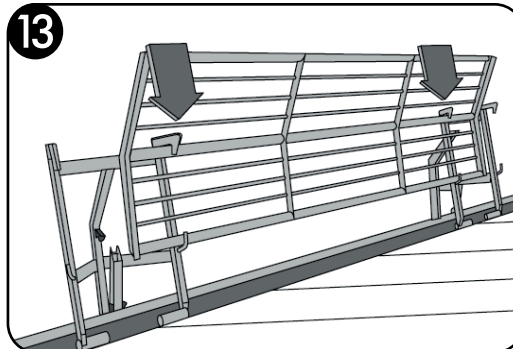
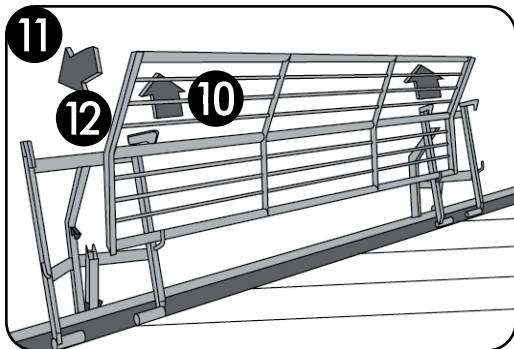

Attention

A toeboard is a necessary part of the safety of the overall system and should always be mounted. Any horizontal gaps shall be less than 120 mm.. The opening between the working surface and the toeboard less than 20 mm!

Placing fencing

- 9 Define direction of the fence (see E 'General conditions of use').
- 10 Open the fencing locks.
- 11 Place the lowest rail of the fence in the fencing hook of the stanchions.
- 12 Press the fencing against the stanchions.
- 13 Block the fencing by closing the fencing locks.
- 14 Check if the vertical distance between the roof surface and the top rail of the fence is at least 1 metre.
- 15^a **Placing toe board**
Hook the toeboard onto the lowest rail of the fence.
- 15^b **Plaatsen haakbeugel**
Hook the bar (height-adjustable) halfway along the fencing at the lowest rail of the fence and fix it with screws (**minimal M8x80 mm stainless**) to the on the roof boarding in the rafters (minimum size 80x140 mm).

D

Installing and dismantling

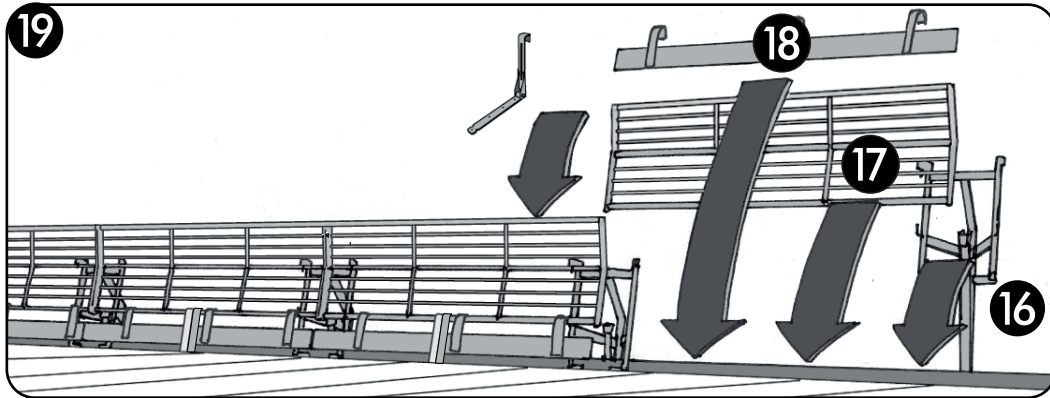

- 16 Place another stanchion, see 3 to 8 .
- 17 Place another closely fitting section of fencing, see 9 to 14 .
- 18 Place another closely fitting section of edge board and bar, see 15^a.
- 19 Repeat the process until sufficient protection has been achieved (according to legal regulations)

Dismantle in reverse order

E

General conditions of use



The RSS system is hung into the roof edge or gutter of a building. Most buildings are suitable for use of the system. There are, however, some situations where it is not suitable. Always check that the following general conditions are met.

As the roof edge/ gutter is **insufficiently strong**, the **RSS safety base plate** should be mounted! (see RSS accessories)

see webshop RSS-Roof
Article number
105

A. With a ROOF EDGE:

- 1) The roof edge has sufficient overhang to hook the stanchion behind it.
- 2) The roof edge and façade are sufficiently strong *. ⚠️
- 3) The roof edge has a roof trim or other type of edge so that the lift-out blocking device (plastic block) stays hooked behind it and the stanchion can not be lifted over the overhang.
- 4) The foot can be fully supported flat against the façade

⚠️ * The RSS system is in principle suitable for appropriate roof edges and zinc box and hanging gutters with adequate gutter brackets (max. 60 cm centre to centre).

The system is not suitable for plastic gutters.

Use the **RSS safety base plate** if the roof edge, gutter and / or façade are insufficiently strong! An installed RSS system must meet local and European requirements (EN 13374 +A1 2019 Class C). If in doubt, please contact your supplier!!

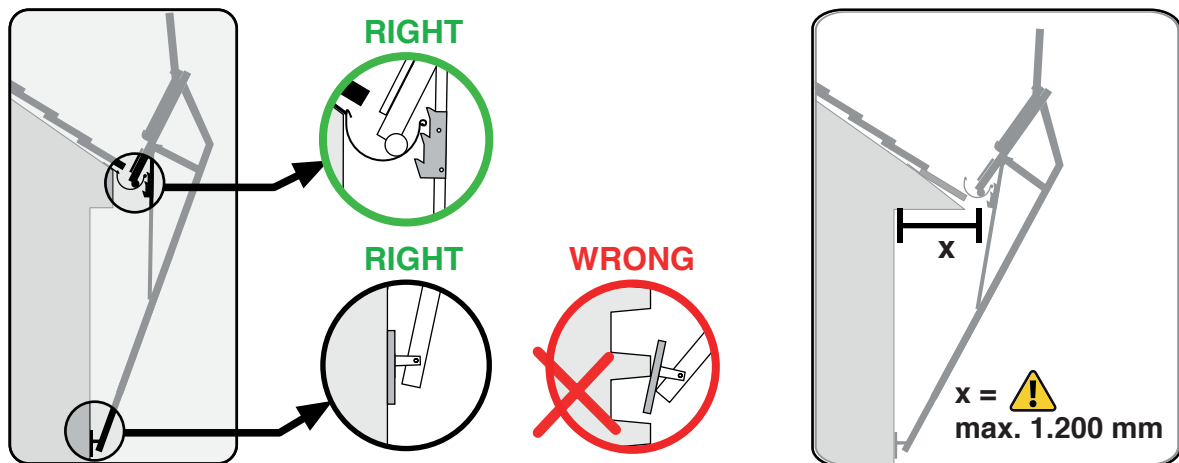

B. With a ROOF GUTTER:

- 1) The gutter is dimensioned and positioned so that the stanchion can hook into the gutter in a stable manner.
- 2) The gutter, gutter brackets and façade are sufficiently strong*). 
- 3) The gutter has a beaded edge or other type of edge so that the lift-out blocking hook. (plastic block) can stay hooked behind it and the stanchion can not be lifted out of the gutter.
- 4) The foot has to be fully flat supported against the façade.



- *) The RSS system is in principle suitable for appropriate roof edges and zinc box and hanging gutters with adequate gutter brackets (max. 60 cm centre to centre).

The system is not suitable for plastic gutters.

Use the **RSS safety base plate** if the roof edge, gutter and / or facade are insufficiently strong! An installed RSS system must meet local and European requirements (EN 13374 +A1 2019 Class C). If in doubt, contact your supplier!!

- 5) The fencing stands at least one meter vertically over the roof surface and the angle between the edge board and the top rail is maximum 15 degrees from the vertical. In order to be able to use the RSS system in many different situations, the fence can be placed with the bended side towards the building or away from the building.

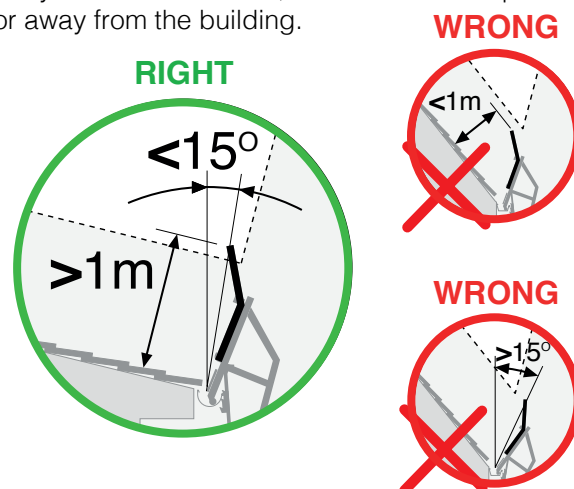

- 6) Never attach other elements (e.g. ropes) to parts of the RSS system!



- 7) Dismantle the system with a wind force greater than 5 bft. Wind force 5: fresh breeze, larger branches and trees move, wind is clearly audible and has a speed of 29 to 38 km / h. (Source: Beaufortskala)
- 8) During snow or sleet, the roof can be slippery and is prohibited, even with the RSS roof edge protection system, to access the roof.
- 9) Only use undamaged and correctly functioning components! Before use check all the components and visually inspect them. All components should be inspected and passed by an expert yearly.
- 10) After a person or object has fallen towards or into the safety system or its accessories, the system may only be reused after inspection by a qualified person (EN 13374 +A1 2019).



> 5 bft



Important

Mandatory PPE during assembly / disassembly RSS roof edge protection system

See our **Pitched roof set basic set** in accessories

This set contains

- safety harness with two hook-on points
- a safety line and a rope grab
- a throwline to get the kernmantel line over the roof
- a sling to create a temporary attachment point.



Article number
PBM-HD



see webshop RSS-Roof

Remarks Max. distance to be covered: 20 m.

Can only be used when there is at least 2 m of free falling space from the foot height of the user.

- Since there is always a risk of falling during installing or disassembling of the system, this only may be carried out by instructed persons. A safe stand is always required for this work.
- Never attach other elements (such as canvas) to parts of the RSS system!
- Always use undamaged and properly functioning parts! Check all parts before use (the most important parts of the system are marked in red) and undergo a visual inspection!

Maintenance and inspection:

All parts of the system must before usage or at least once a year undergo a expert inspection. This test must, for a appropriate occupational health and safety policy, be recorded in writing. The systems are reliable and can be used as:



- No damage or permanent changes in any form are observed.
- Bolts and split pins are in perfect condition, have good spring pressure and are functional.
- Holes and notches in the clutch plates are undamaged and ensure a good fit.
- The aluminum parts and plastic parts have no cracks or cracks other damages
- Metal parts have no corrosion damage
- The marking on the nameplates is present

Article number
INSP-D01



see webshop RSS-Roof

Download your own inspection list (INSP-D01) for free for daily use of our website!

We are also happy to carry out the annual mandatory inspection for you.
See our website www.rss-roof.com.

F**Revision log**

revision	date	description
2020-HLD-REV001	01-10-2020	manual rewritten according to EN 13374 +A1 2019

G**Notes**

Dealer Roof Safety Systems**WORK SAFE SAVE TIME**

ROOF SAFETY SYSTEMS BV
BY DROSTE BEJAH

Roof Safety Systems BV | Asjeskampweg 4 | 7772 AZ Hardenberg
| The Netherlands | info@rss-roof.com
| www.rss-roof.com

