

# DIMLUX EXPERT SERIES

## USER MANUAL

EN

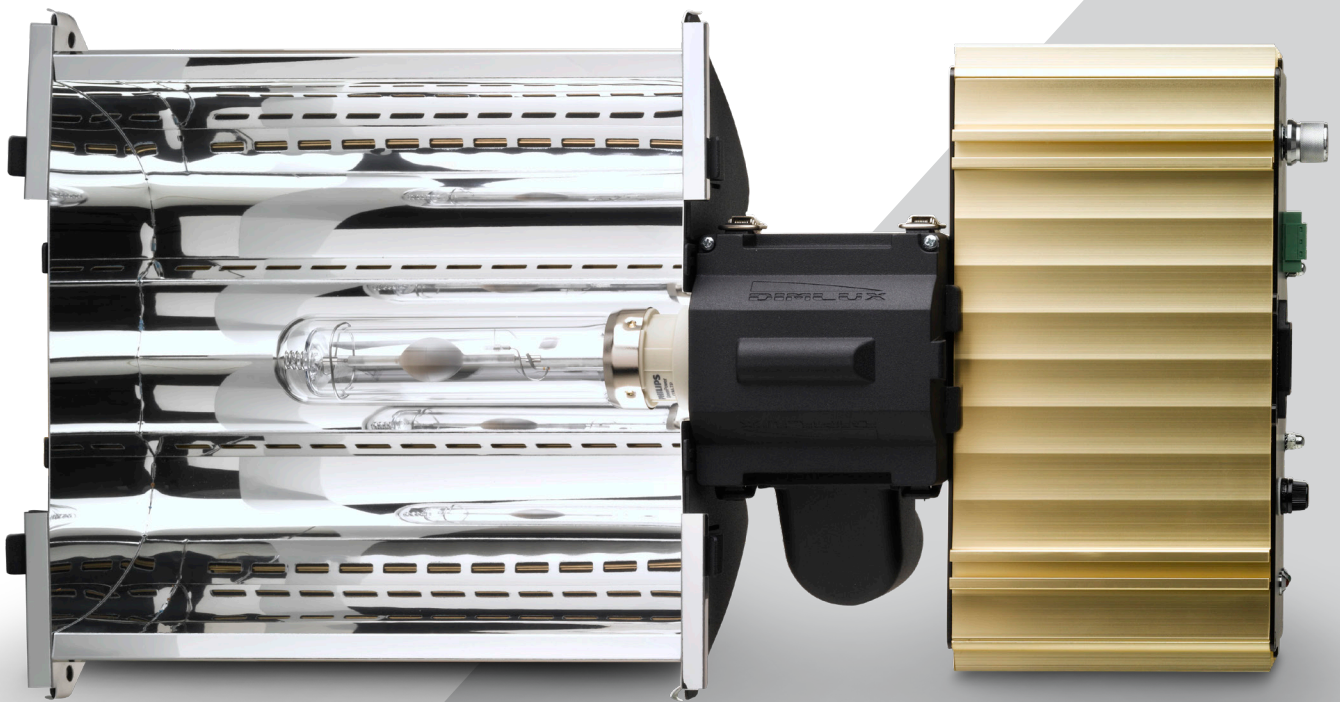

**DIMLUX**



All manuals at:

 [www.theclimatefactory.com](http://www.theclimatefactory.com)

Any other information:

 [info@theclimatefactory.com](mailto:info@theclimatefactory.com)

## TECHNICAL SPECIFICATIONS

### Reflector Alpha Optics 98

The Alpha Optics 98 reflector has been designed according to the SBCS (Single Bounce Clear Sight) principle and is manufactured with Miro Silver mirrors. In this way, the maximum possible efficiency (98%) of all existing horticultural reflectors is achieved.

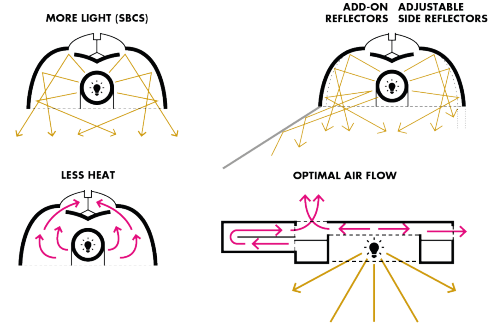

### DimLux Expert series equipment and Xtreme ballasts

- The maximum output power (brightness) by supercharging (boost) and 400V
- The maximum attenuation range of all digital ballasts
- Soft-Start function, Soft-Dim, Soft-Off
- Manual attenuation in 8 positions, including shutdown
- Smooth attenuation with the MaxiController
- More diagnostic leds
- EOL function (warning when lamps need to be changed)

## FULL SPECTRUM 315W



**Complete fixture with 315W Xtreme ballast, Dimlux Daylight CMH 315W 3K/4K agro lamp and Alpha Optics 98 Reflector**

- Dim levels: Soft-Off, 165W, 205W, 245W, 280W, 315W, 345W, 380W
- Power consumption at 315W= 331W, 1.4A at 230V
- Power consumption at boost 380W= 399W, 1.7A at 230V
- System PPF at 380W= 706umol/s
- Illumination surface:
  - at 315W= min 0.42m<sup>2</sup> / max 1m<sup>2</sup>
  - at 380W= min 0.5m<sup>2</sup> / max 1.2m<sup>2</sup>
- ø 50mm (2") connection for active extraction
- Dimensions: 530x275x130mm (20.8"x10.8"x5.1")
- Weight 4.9kg (10.80lbs)

## DUAL FULL SPECTRUM 630W

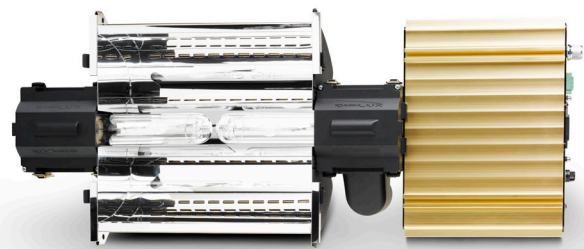

**Complete fixture with 630W Xtreme ballast, 2x Dimlux Daylight CMH 315W 3K/4K agro lamps and Alpha Optics 98 Reflector**

- Available with NanoTubes
- Dim levels: Soft-Off, 330W, 410W, 490W, 560W, 630W, 690W, 760W
- Power consumption at 630W= 662W, 2.7A at 230V
- Power consumption at boost 760W= 799W, 3.5A at 230V
- System PPF at 760W= 1,411 umol/s
- Illumination surface:
  - at 630W= min 0.84m<sup>2</sup> / max 2m<sup>2</sup>
  - at 760W= min 1m<sup>2</sup> / max. 2.4m<sup>2</sup>
- ø 50mm (2") connection for active extraction
- Dimensions: 675x275x130mm (26.5"x10.8"x5.1")
- Weight 6.3kg (13.88lbs)

## TECHNICAL SPECIFICATIONS

### Reflector Alpha Optics 98

The Alpha Optics 98 reflector has been designed according to the SBCS (Single Bounce Clear Sight) principle and is manufactured with Miro Silver mirrors. In this way, the maximum possible efficiency (98%) of all existing horticultural reflectors is achieved.

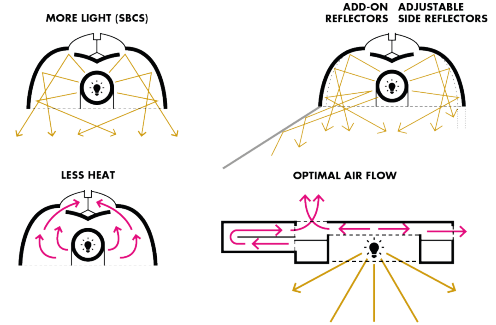

### DimLux Expert series equipment and Xtreme ballasts

- The maximum output power (brightness) by supercharging (boost) and 400V
- The maximum attenuation range of all digital ballasts
- Soft-Start function, Soft-Dim, Soft-Off
- Manual attenuation in 8 positions, including shutdown
- Smooth attenuation with the MaxiController
- More diagnostic leds
- EOL function (warning when lamps need to be changed)

### EL UHF 600W

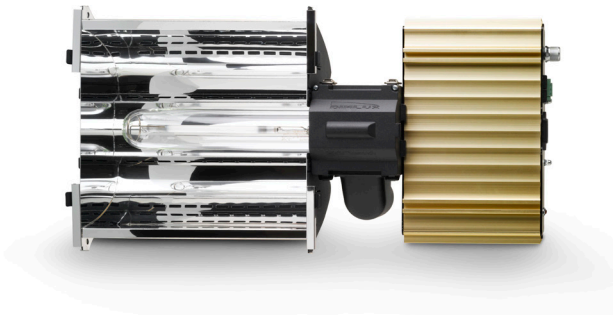

**Complete fixture with 600W Xtreme ballast, 600W 400V EL Philips lamp and Alpha Optics 98 Reflector**

- Available with NanoTubes
- Dim levels: Soft-Off, 320W, 390W, 460W, 530W, 600W, 645W, 690W
- Power consumption at 600W= 630W, 2.7A at 230V
- Power consumption at boost 690W= 724W, 3.1A at 230V
- System PPF at 690W= 1,341 umol/s
- Illumination surface:  
at 600W= min 0.78m<sup>2</sup> (8.39ft<sup>2</sup>), max 2m<sup>2</sup> (21.52ft<sup>2</sup>)  
at 690W= min 0.9m<sup>2</sup> (9.68ft<sup>2</sup>), max 2.3m<sup>2</sup> (24.75ft<sup>2</sup>)
- ø50mm (2") connection for active extraction
- Dimensions 550x275x130mm (21.6"x10.8"x5.1")
- Weight 5.1kg (11.24lbs)

### DE EL 1000W

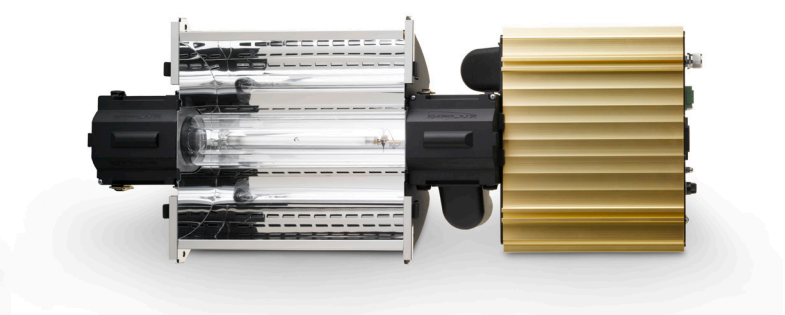

**Complete fixture with 1.000W Xtreme ballast, 1.000W 400V EL Philips lamp and Alpha Optics 98 Reflector**

- Available with NanoTubes
- Dim levels: Soft-Off, 600W, 700W, 800W, 900W, 1.000W, 1.100W, 1.200W
- Power consumption at 1.000W = 1.050W 4.5A at 230V
- Power consumption at boost 1.200W = 1.260W, 5.2A at 230V
- System PPF at 1.200W= 2,470umol/s
- Illumination surface  
at 1.000W= min 1.4m<sup>2</sup> (15.06ft<sup>2</sup>), max 3.3m<sup>2</sup> (35.52ft<sup>2</sup>)  
at 1.200W= min 1.65m<sup>2</sup> (17.76ft<sup>2</sup>), max. 4m<sup>2</sup> (43.05ft<sup>2</sup>)
- ø50mm (2") connection for active extraction
- Dimensions 675x275x130mm (26.5"x10.8"x5.1")
- Weight 6.3kg (13.88lbs)

## INSTALLATION

Before installing, make sure the installation complies the regulations of your country.

The Dimlux Expert series can be controlled with the Dimlux Maxi Controller or by using external switching gear (contactors, timers). Make sure the contactors and timers are designed to match the load of the ballasts.



### DIMLUX MAXI CONTROLLER

The Maxi Controller can control up to 160 Dimlux Expert fixtures at once. A switchboard, time delay timers, timers and relays (contactors) are no longer needed. The power cord of the fixture can be directly plugged into a power socket. Lights on and off times, brightness and many more items can be set with the Maxi Controller.

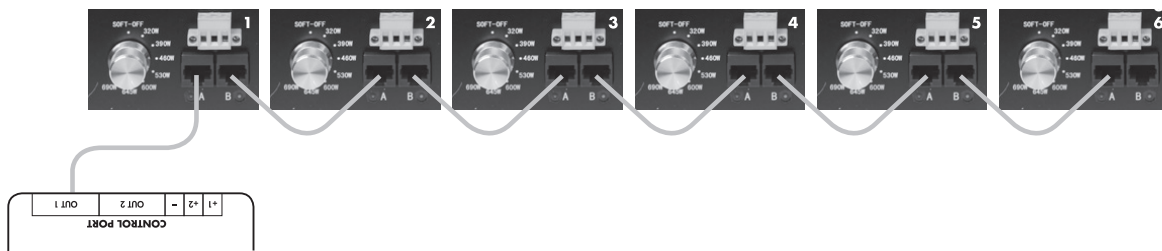

Another options for existing and old systems

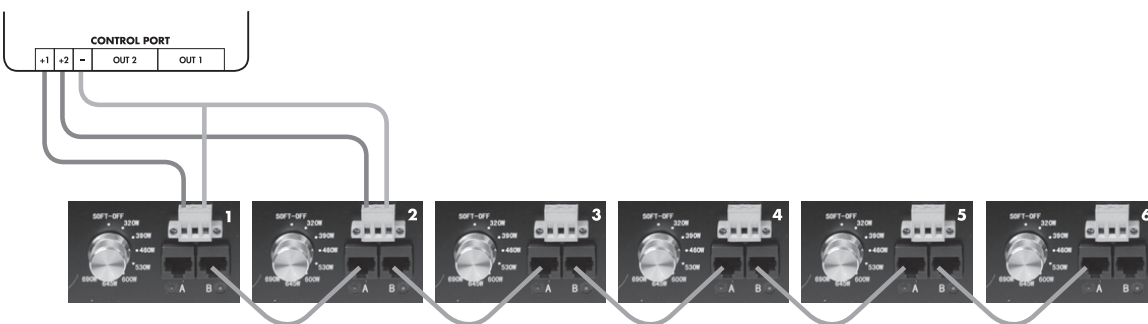

The Maxi Controller sends a signal to the fixtures to switch them on or off. There are 4 ports on the Maxi controller, each port can switch up to 40 fixtures. To connect the signal wire from the controller to the first fixture and looping it to the next, we suggest to use a black/red wire (speaker cable) so + and - are not mixed up.

Please refer to the Maxi Controller manual for specific information regarding to settings and set-up.

## INSTALLATION/MOUNTING

On the rail upper side of the fixture are indicators to help you find the perfect balance when mounting the supplied brackets.

1 Alpha 98 Optics

2 600W and 315W fixture

3 1000W and 630W fixture

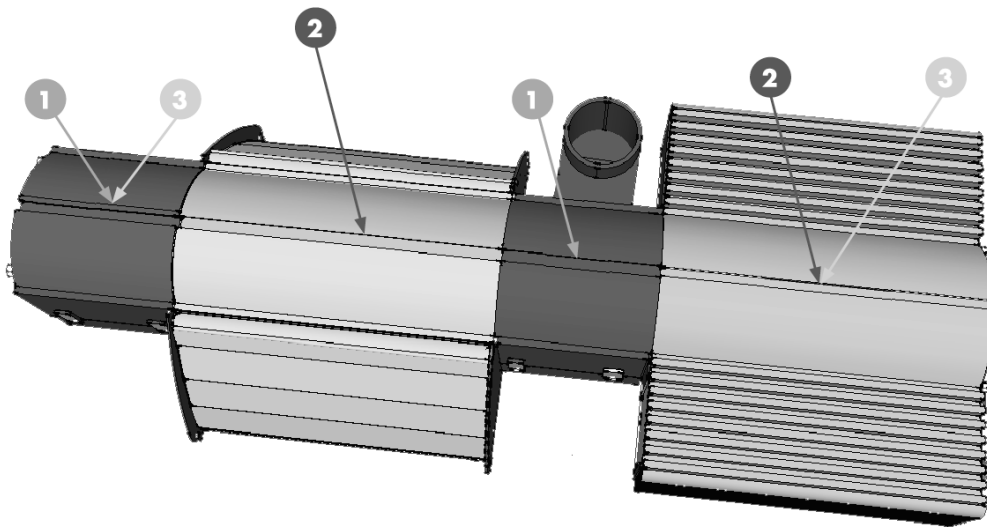

## INSTALLATION/MOUNTING/SUITABLE LAMPS

### DIMLUX EXPERT 315W (DUAL)

- Dimlux Daylight CMH 315W 3K agro
- Dimlux Daylight CMH 315W 4K agro

### DIMLUX EXPERT 600W EL UHF

- Philips greenpower 600W EL UHF (400 voltios)
- Sylvania Grolux 600W 400 voltios

### DIMLUX EXPERT 1000W EL UHF

- 1000W 400V EL double ended UHF

## DIAGNOSE/DIAGNOSE INDICATORS

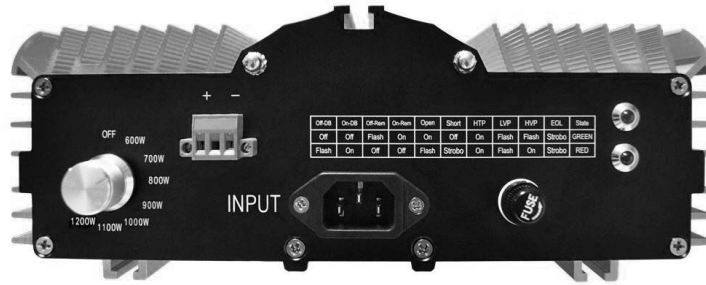

The old ballast comes with 2 diagnose indicator led's. One green and one red. The chart next to the led's indicates what error or status is present.

Off-DB	On-DB	Off-Rem	On-Rem	Open	Short	HTiP	LVP	HVP	EOL	Estado
Off	Off	Flash	On	On	Off	On	Flash	Flash	Strobo	Verde
Flash	On	Off	Off	Flash	Strobo	On	Flash	On	Strobo	Rojo

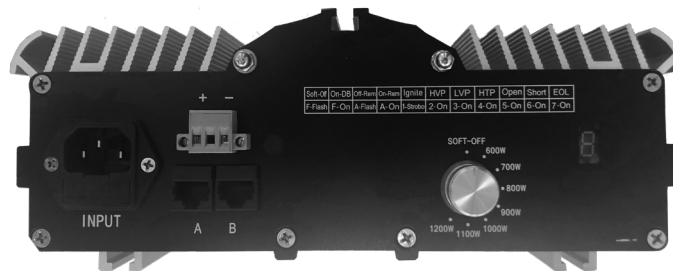

The Dimlux ballast has an own autodiagnose system. An screen on the ballast or lighting system makes possible to see an error alert and the status.

SOFT-OFF	Off-DB	On-DB	Off-Rem	On-Rem	IGNITE	HVP	LVP	HTP	Open	Short	EOL
Flash	F-On	A-Flash	A-On	A-On	1 Strobo	2-On	3-On	4-On	5-On	6-On	7-On

- Off-DB** = Ballast is switched off by dim button.
- On-DB** = Ballast is switched on by dim button.
- Off- Rem** = Ballast is switched off by remote (maxi controller)
- On-Rem** = Ballast is switched on by remote (maxi controller)
- Open** = Ballast is off because of an open contact or defect bulb
- Short** = Ballast is off because of short-circuit or defect bulb
- HTP** = Ballast is off because of High Temperature Protection (ballast is to hot)
- LVP** = Ballast is off because of Low Voltage Protection
- HVP** = Ballast is off because of High Voltage Protection
- EOL** = Ballast is off because of bulb End Of Life

- When both led's are off, check fuse and power supply.
- Strobo is a very fast flash

Note; make sure the dim button is not in the off position when using the maxi controller.

## LAMP REPLACEMENT

1. Remove Philips screws



2. Open latches

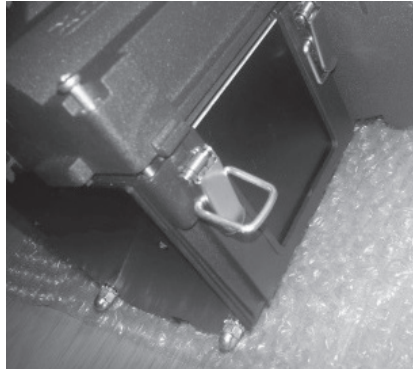

3. Open and remove cover

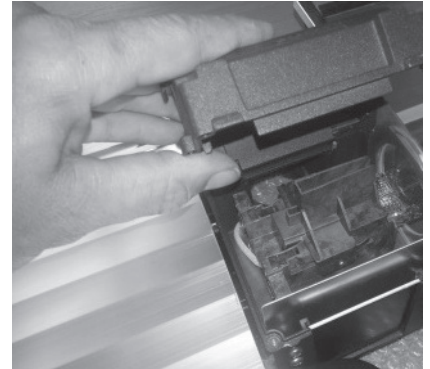

4. Slide fittings on both sides away from the lamp and lift out lamp

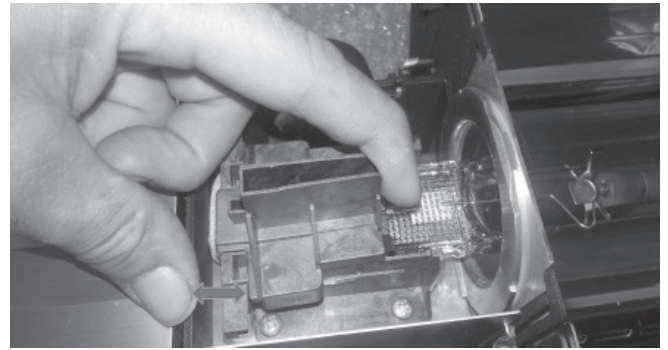
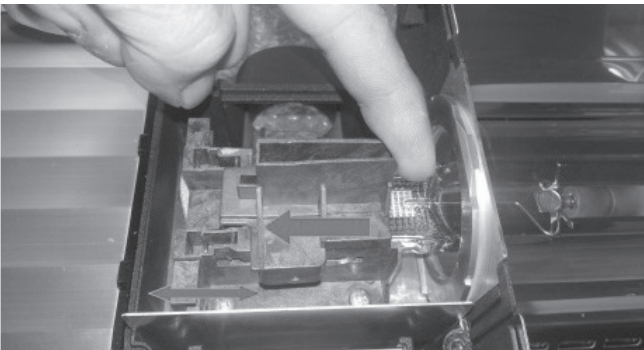

5. When replacing the lamp, make sure the glass vacuum seal (1) points away from the reflector and the getter (2) is on the ballast side

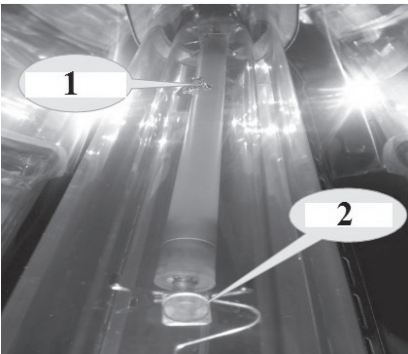

6. Make sure the contact wire is straight and not twisted before closing the fitting

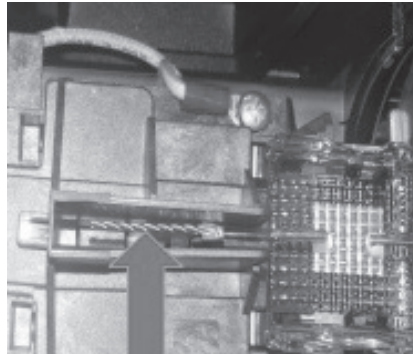

7. Slide fittings on both side of the lamp firmly towards the lamp



8. Slide fittings on both side of the lamp firmly towards the lamp



9. Close the cover, secure the latches and turn the Philips screws back in.



## LAMP REPLACEMENT

### ALWAYS WEAR GLOVES!

The 315watt cdm lamp has a bayonet connector. The lamp must be inserted in the fitting in such a way that the contact-pins fit the holes in the fitting. The 2 contact pins are shaped in a different way. Push the lamp into the fitting and turn to lock the lamp. The 1000watt DE lamp has 2 slide fittings.



## LAMP REPLACEMENT

### Remove Bulb(s) before replacement

1. Bend open side to unlock

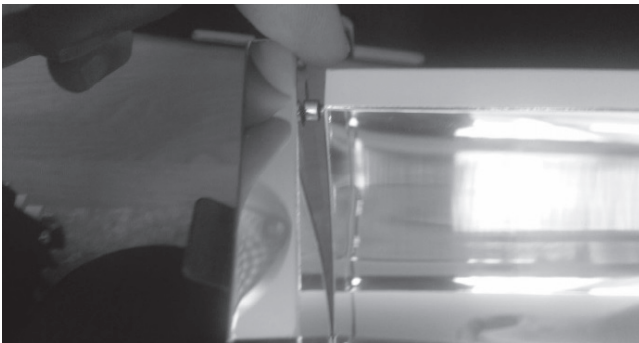

2. Open reflector all the way

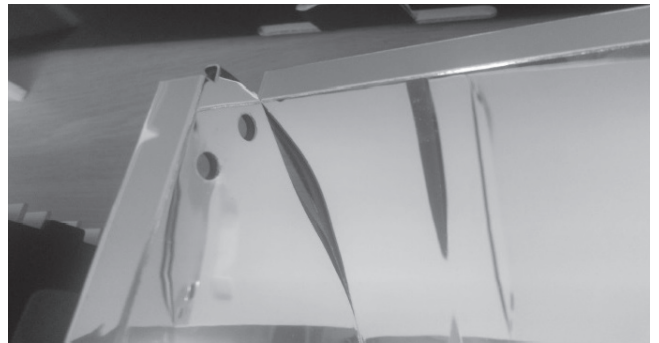

3. Pry end of reflector open



4. Lift reflector straight out

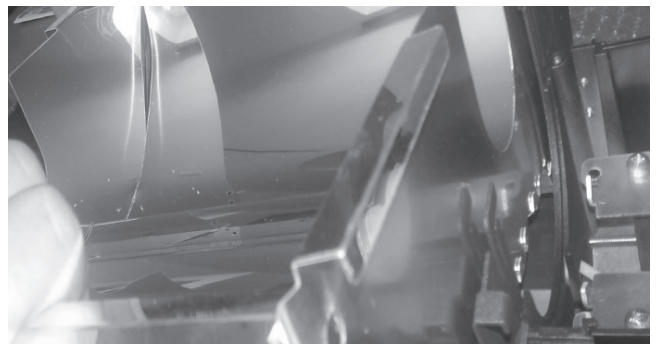

- Discard old reflector, do not re use
- Mount new reflector in opposite way



## GENERAL USE

### AIR

The open reflector versions have openings in the top of the reflective portion in a way that no direct light can shine through. By natural convection, the heat will escape through these openings and thus cooling the lamp.

There is also a 50 mm connection to connect active air removal to reduce the room temperature even more. The amount of air extracted through the 50 mm connection must be 200 m<sup>3</sup>/hour for each lamp. (no matter if it's a 315/600 or 1000watt fixture)

Additional T-joints and 50mm tube can be supplied, the T-joints are 125-50-125mm, 150-50-150, 160-50-150mm and 200-50-200mm.

### BOOST AND COOLING

Boosting light output will increase the temperature of the lamp. Due to the open structure of the reflector, the lamp temperature will remain within its optimum limits. Without this indirect cooling, the lamp efficiency will decrease. It's even so that when hot air is actively extracted, the efficiency of the lamp will slightly increase. The lamp is not cooled too much because the reflector is constructed in such a way the air is not removed at the lamp itself but around it.

### OPTICAL DESIGN

The main goal in designing the reflector was achieving the highest efficiency (light output) possible. It's designed according to the SBCS (Single Bounce Clear Sight) principle which means that each light beam reflects only one single time in the reflector and then goes out directly (Single Bounce). After reflection, the beam is not hindered by the lamp or other parts (Clear Sight). The design from the reflector is optically perfect so that no hammered or textured pattern is needed to spread hotspots. Hammered or textured reflective reflectors are made to improve uniformity and create undesirable multiple reflections inside the reflector and cause internal reflections from the reflector to the lamp causing a decrease in efficiency. This techniques used in our reflector combined with the use of Miro Silver mirror will provide unparalleled results.

### AJUSTING

The reflector has adjustable side-reflectors with 2 positions, a wide position and a deep position. The "wide" position gives an overlap in a multi reflector set-up. The footprint ratio is 0,8:1. When the reflector is next to walls or in a square one lamp room, the adjustable side-reflector is set to the "deep" position and the footprint image is 1:1.

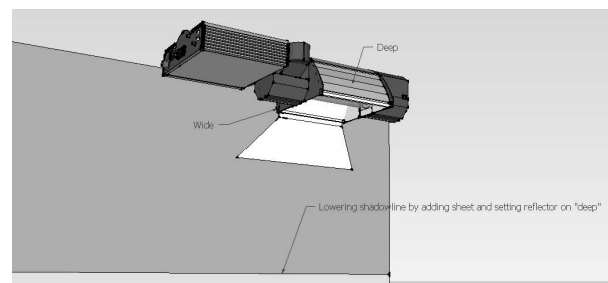
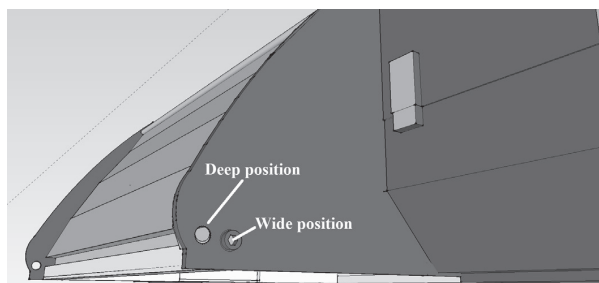

When the side-reflector is moved to the outer position, the reflector is in "deep" position, when moving the side-reflector towards the lamp the reflector is in "wide" position.

## GENERAL USE

### ADD-ON REFLECTORS (WINGS)

The full fixture or separate Alpha Optics reflector can be fitted with loose add-on reflectors. The reflectors that are adjacent to a wall or corner can be equipped with these wings to minimise reflection losses through a wall. These wings have a hammered texture because the angle of reflection is so large that the SBCS principle is maintained. Reflectors next to a wall all get one wing, reflectors in a corner can be fitted with 2 wings and reflectors in the middle of a room get no wings. Add-on reflectors, minimise wall losses and give more light to the surroundings from the illuminated grid.

The add-on reflectors are available as overlapping and non overlapping models. The overlapping models are used in a multi row set-up and the non overlapping models are used when there is only one row of reflectors in the room.

### HOW HIGH?

There is a very simple and unique way to determine the minimum height of the reflector. Rule of thumb is that the shortest distance from reflector to crop is minimum half the distance between the other reflectors in a multi lamp set-up. It doesn't matter if the lamp is 400 watt or 1000 watt. It's obvious that a 1000 watt lamp illuminates a larger surface than a 400 watt lamp, automatically increasing distance between reflector and crop.

A reflector hanging lower than calculated will increase hotspots and decrease uniformity. Lower is not better!

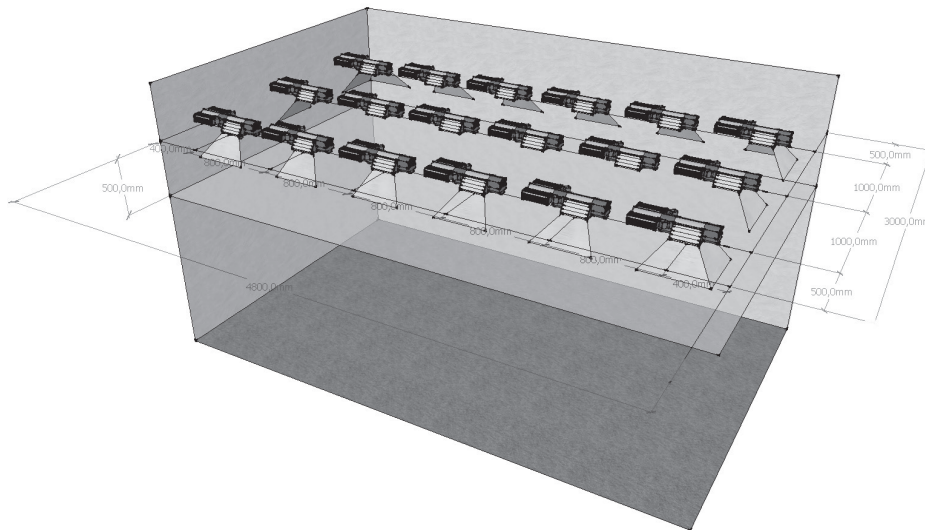

### DISTANCE

Distance between reflectors depends on the lamp, not the reflector. Maximum light output for most crops is 1500  $\mu\text{mol}/\text{m}^2/\text{s}$ .

### Example:

The 600 watt EL UHF lamp output is 1190  $\mu\text{mol}$ , with boost it's almost 1370  $\mu\text{mol}/\text{m}^2/\text{s}$ . There will be some light loss due to reflections loss from walls and reflector. Because boost gives more efficiency with cooled lamps and using addon wings the light output will be almost the same. 1370  $\mu\text{mol}/\text{m}^2/\text{s}$  is almost the limit when illuminating 1m<sup>2</sup> with 1 reflector and a 600watt EL UHF lamp. 0,8m<sup>2</sup> is the maximum.

EN



**TheClimateFactory**

Steenweg op Hoogstraten  
72 Unit 6  
2330 Merksplas  
België

+32 14783416

**All manuals at:**

 [www.theclimatefactory.com](http://www.theclimatefactory.com)

**Cualquier consulta:**

 [info@theclimatefactory.com](mailto:info@theclimatefactory.com)

**DIMLUX**

© Airsupplies