

INTRODUCTION MANUAL

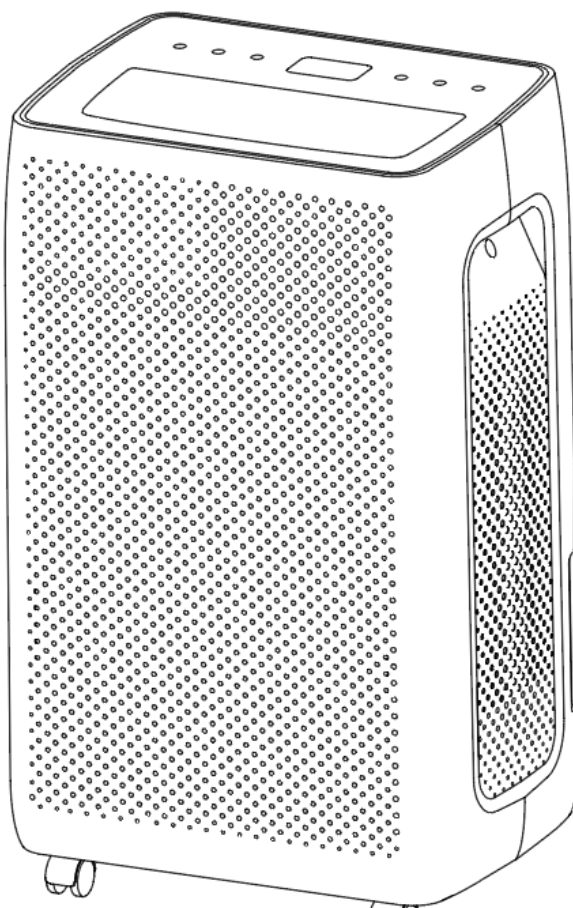

Please keep this manual carefully for further reference!

Thank you for selecting our dehumidifier. Be sure to read this manual carefully before using it. Any questions, please contact the professional service for help.

QC068DF

CONTENT

1. BEFORE YOU BEGIN
2. FOR YOUR SAFETY
3. PRODUCT OVERVIEW
4. INSTALLATION
5. OPERATION
6. MAINTENANCE
7. TROUBLESHOOTING
8. DECOMMISSIONING

1. BEFORE YOU BEGIN





Please read the operating instructions carefully before using your dehumidifier for the first time.

1.1 PRODUCT DESCRIPTION

The dehumidifier is used to remove excessive moisture from the air. The resulting reduction in relative humidity protects buildings and their contents from the adverse effects of excess humidity.

The environmentally friendly R290 is used as the refrigerant. R290 has no damaging influence on the ozone layer (ODP), a negligible greenhouse effect (GWP) and is available worldwide. Because of its efficient energy properties, R290 is highly suitable as a coolant for this application. Special precautions must be taken into consideration due to the coolant's high flammability.

SYMBOLS FROM THE UNIT AND USER MANUAL

 warning	This unit uses a flammable refrigerant. If refrigerant leaks and comes in contact with fire or heating part, it will create harmful gas and there is risk of fire.
	Read the USER MANUAL carefully before operation.
	Further information is available in the USER MANUAL, SERVICE MANUAL, and the like.
	Service personnel are required to carefully read the USER MANUAL and SERVICE MANUAL before operation.

1.2 THE FOLLOWING SHOULD ALWAYS BE OBSERVED FOR SAFETY

- This appliance is intended to be used by expert or trained users in shops, in light industry and on farms, or for commercial use by lay persons.
- This appliance can be used by children aged from 8 years and above and persons with reduced physical, sensory or mental capabilities or lack of experience and knowledge if they have been given supervision or instruction concerning use of the appliance in a safe way and understand the hazards involved. Children shall not play with the appliance. Cleaning and user maintenance shall not be made by children without supervision.
- The unit is designed only for use with R-290(propane) gas as the designated refrigerant.
- The refrigerant loop is sealed. Only a qualified technician should attempt to service!
- Do not discharge the refrigerant into the atmosphere.
- R-290 (propane) is flammable and heavier than air.
- It collects first in low areas but can be circulated by the fans.
- If propane gas is present or even suspected, do not allow untrained personnel to attempt to find the cause.
- The propane gas used in the unit has no odor.
- The lack of smell does not indicate a lack of escaped gas.
- If a leak is detected, immediately evacuate all persons from the store, ventilate the room and contact the local fire department to advise them that a propane leak has occurred.
- Do not let any persons back into the room until the qualified service technician has arrived and that technician advises that it is safe to return to the store.
- No open flames, cigarettes or other possible sources of ignition should be used inside or in the vicinity of the units.
- Component parts are designed for propane and non-incentive and non-sparking. Component parts shall only be replaced with identical repair parts.

FAILURE TO ABIDE BY THIS WARNING COULD RESULT IN AN EXPLOSION, DEATH, INJURY AND PROPERTY DAMA

2. FOR YOUR SAFETY

Your safety is the most important thing we concerned!



Please read this manual carefully and fully understand before operating your dehumidifier.

2.1 OPERATIONAL PRECAUTIONS

WARNING- to reduce the risk of fire, electric shock or injury to persons or property:

- If the supply cord is damaged, it must be replaced by the manufacturer, its service agent or similarly qualified persons in order to avoid a hazard.
- The appliance shall be disconnected from its power source during maintenance.
- Always operate the unit from a power source of equal voltage, frequency and rating as indicated on the product identification plate.
- Always use a power outlet that is grounded.
- Unplug the power cord when cleaning or when not in use.
- Do not operate with wet hands. Prevent water from spilling onto the unit.
- Do not immerse or expose the unit to rain, moisture or any other liquid.
- Do not leave the unit running unattended. Do not tilt or turn over the unit.
- Do not unplug while the unit is operating.
- Do not unplug by pulling on the power cord.
- Do not use an extension cord or an adapter plug.
- Do not put objects on the unit.
- Do not climb or sit on the unit.
- Do not insert fingers or other objects into the air outlet.
- Do not touch the air inlet or the aluminum fins of the unit.
- Do not operate the unit if it is dropped, damaged or showing signs of product malfunction.
- Do not clean the appliance with any chemicals.
- Ensure the unit is far away from fire, inflammable, or explosive objects.

- The unit shall be installed in accordance with national wiring regulations.
- Do not use means to accelerate the defrosting process or to clean, other than those recommended by the manufacture.
- The appliance shall be stored in a room without continuously operation sources (for example: open flames, an operating gas appliance or an operating electric heater).
- The appliance shall be stored so as to prevent mechanical damage from occurring.
- Do not piece or burn, even after use.
- Be aware that refrigerants may not contain an odour.
- Pipe-work shall be protected from physical damage and shall not be installed in an unventilated space, if that space is smaller than 4m².
- Compliance with national gas regulations shall be observed.
- Keep any required ventilation openings clear of obstruction.
- The appliance shall be stored in a well-ventilated area where the room size corresponds to the room area as specified for operation..

 Any person who is involved with working on or breaking into a refrigerant circuit should hold a current valid certificate from an industry-accredited assessment authority, which authorizes their competence to handle refrigerants safely in accordance with an industry, recognized assessment specification.

 Servicing shall only be performed as recommended by the equipment manufacturer. Maintenance and repair requiring the assistance of other skilled personnel shall be carried out under the supervision of the person competent in the use of flammable refrigerants.

If you don't understand something or need help, please contact the dealer services

2.2 SAFETY PRECAUTIONS ON SERVICING

Please follow these warnings when to undertake the following when servicing a dehumidifier with R290.

2.2.1 Checks to the area

Prior to beginning work on systems containing flammable refrigerants, safety checks are necessary to ensure that the risk of ignition is minimized. For repair to the refrigerating system, the following precautions shall be complied with prior to conducting work on the system.

2.2.2 Work procedure

Work shall be undertaken under a controlled procedure so as to minimize the risk of a flammable gas or vapor being present while the work is being performed.

2.2.3 General work area

All maintenance staff and others working in the local area shall be instructed on the nature of work being carried out. Work in confined spaces shall be avoided. The area around the workspace shall be sectioned off. Ensure that the conditions within the area have been made safe by control of flammable material.

2.2.4 Checking for presence of refrigerant

The area shall be checked with an appropriate refrigerant detector prior to and during work, to ensure the technician is aware of potentially flammable atmospheres. Ensure that the leak detection equipment being used is suitable for use with flammable refrigerants, i.e. no sparking, adequately sealed or intrinsically safe.

2.2.5 Presence of fire extinguisher

If any hot work is to be conducted on the refrigeration equipment or any associated parts, appropriate fire extinguishing equipment shall be available to hand. Have a dry powder or CO₂ fire extinguisher adjacent to the charging area.

2.2.6 No ignition sources

No person carrying out work in relation to a refrigeration system which involves exposing any pipe work that contains or has contained flammable refrigerant shall use any sources of ignition in such a manner that it may lead to the risk of fire or explosion. All possible ignition sources, including cigarette smoking, should be kept sufficiently far away from the site of installation, repairing,

removing and disposal, during which flammable refrigerant can possibly be released to the surrounding space. Prior to work taking place, the area around the equipment is to be surveyed to make sure that there are no flammable hazards or ignition risks. "No Smoking" signs shall be displayed.

2.2.7 Ventilated area

Ensure that the area is in the open or that it is adequately ventilated before breaking into the system or conducting any hot work. A degree of ventilation shall continue during the period that the work is carried out. The ventilation should safely disperse any released refrigerant and preferably expel it externally into the atmosphere.

2.2.8 Checks to the refrigeration equipment

Where electrical components are being changed, they shall be fit for the purpose and to the correct specification. At all times the manufacturer's maintenance and service guidelines shall be followed. If in doubt consult the manufacturer's technical department for assistance.

The following checks shall be applied to installations using flammable refrigerants:

- The charge size is in accordance with the room size within which the refrigerant containing parts are installed;
- The ventilation machinery and outlets are operating adequately and are not obstructed;
- If an indirect refrigerating circuit is being used, the secondary circuit shall be checked for the presence of refrigerant;
- Marking to the equipment continues to be visible and legible. Markings and signs that are illegible shall be corrected;
- refrigeration pipe or components are installed in a position where they are unlikely to be exposed to any substance which may corrode refrigerant containing components, unless the components are constructed of materials which are inherently resistant to being corroded or are suitably protected against being so corroded.

2.2.9 Checks to electrical devices

Repair and maintenance to electrical components shall include initial safety checks and component inspection procedures. If a fault exists that could compromise safety, then no electrical supply shall be connected to the circuit until it is satisfactorily dealt with. If the fault cannot be corrected immediately but it is necessary to continue operation, an adequate temporary solution shall

be used. This shall be reported to the owner of the equipment so all parties are advised.

Initial safety checks shall include:

- those capacitors are discharged: this shall be done in a safe manner to avoid possibility of sparking;
- that there no live electrical components and wiring are exposed while charging, recovering or purging the system;
- that there is continuity of earth bonding



3. PRODUCT OVERVIEW

3.1 FRONT VIEW

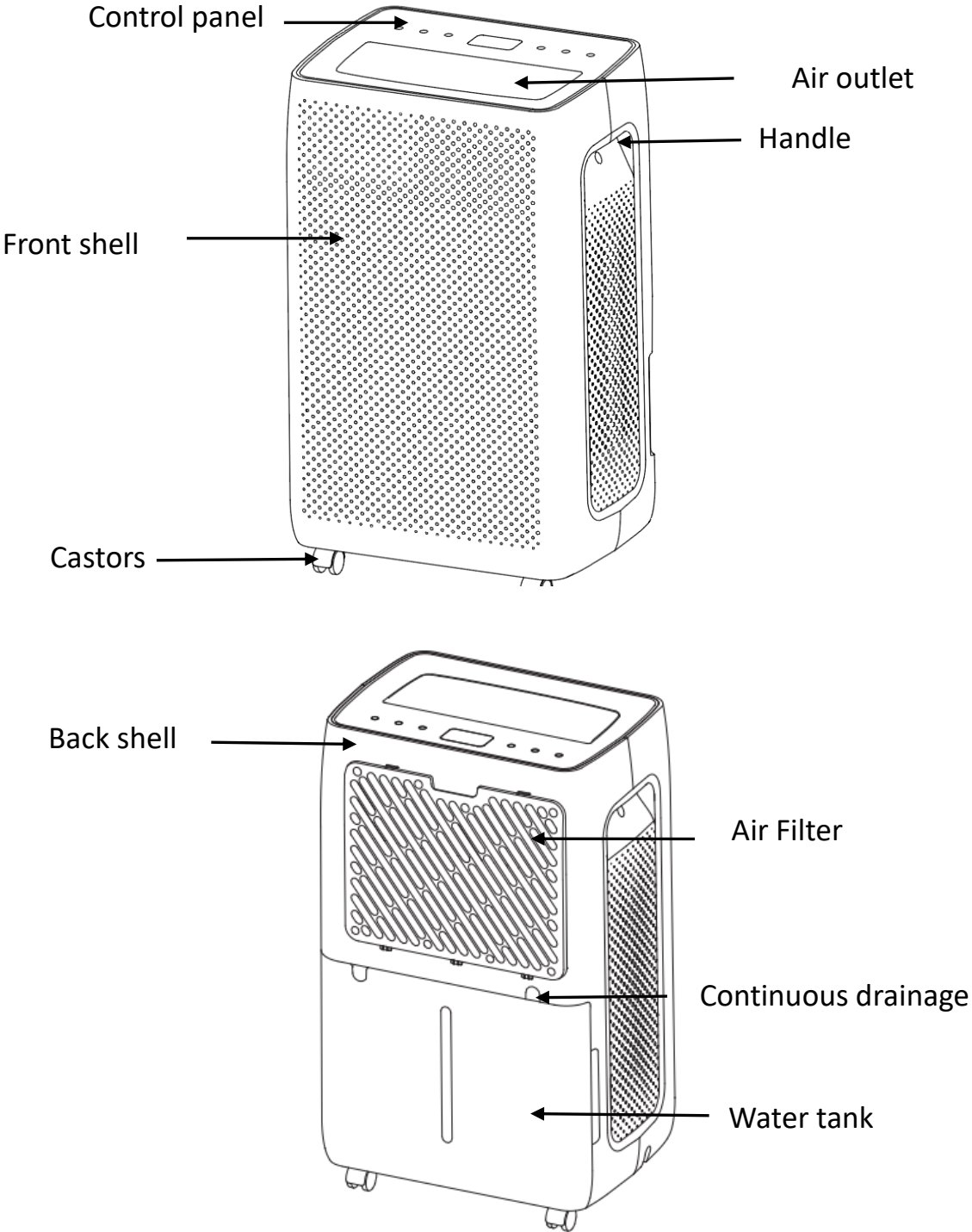

3.2 FEATURES

- Powerful moisture removal
- Humidity Display shows current air humidity
- Auto mode adjusts humidity levels
- 24-hour timer to set the time of operation
- Effectively remove moisture, dust from the air
- Low power consumption-energy efficient
- Quiet fan has two speed settings
- Auto-Defrost at low temperature
- Auto shut-off/ auto restart
- Electronic control
- Laundry drying function
- Nylon Filter
- Continuous drainage or 4.5L water tank
- With auto swing function

4. INSTALLATION

4.1 LOCATION

1. Place the unit on a firm, level surface in an area with at least 30cm of free space around it to allow for proper air circulation.
2. Never install the unit where it could be subject to:
 - Heat sources such as radiators, heat registers, stoves or other products that produce heat.
 - In an area where oil or water may be splashed
 - Direct sunlight
 - Mechanical vibration or shock
 - Excessive dust
 - Lack of ventilation, such as cabinet or bookcase

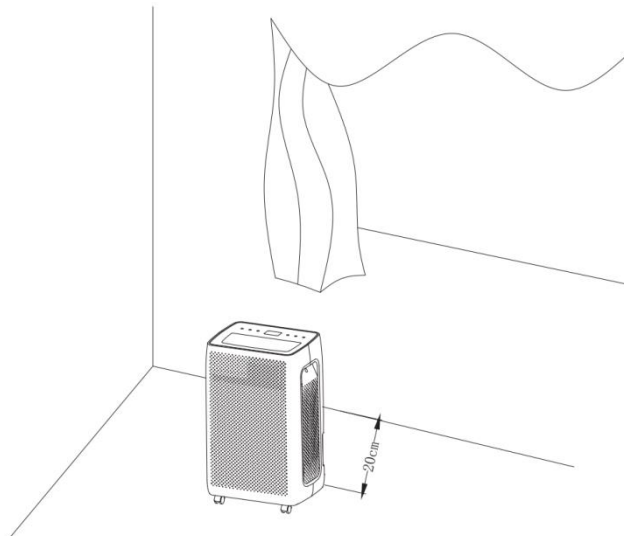

WARNING

Install the unit in rooms which exceed 4 m².
Do not install the unit in a place where inflammable gas may leak



NOTE

The manufacture may provide other suitable example or may provide additional information about the refrigerant odour.

4.2 OPERATING THE DEVICE SAFELY

- Check the device after unpacking for any damages or scratches on it.
- Operate this unit in an ambient temperature from 5°C to 38°C.
- Do not use in the outdoors. This dehumidifier is intended for indoor residential applications only.
- Do not operate in close proximity to walls, curtains, or other objects that may block inlet and outlet.
- Keep the air inlet and outlet free of obstacles.
- Adjusting the wind deflector in the upward direction prior to start up.
- If tipped more than 45°, allow the unit to set upright for at least 24 hours before start up.
- Keep doors and windows close for better energy saving.
- Do not operate or store the unit in direct sunlight or rain.
- It is normal for air outlet to feel warm to touch after continuous operation on hot days.
- Empty the water tank before moving the device.
- Make sure the Water tank is correctly fitted otherwise the unit will not operate properly.
- The dehumidifier starts up in the mode selected when the unit was last used.
- The dehumidifier starts dehumidifying if the room humidity is 3% higher than the selected humidity.
- There is a protective 3-minutes time delay of the compressor. Wait 3 minutes for the dehumidifier to resume dehumidification.

5. OPERATION

5.1 CONTROL PANEL



FUNCTION KEYS AND INDICATORS

1.	POWER button	Touch this button to switch the machine on or off.
2.	Mode Button	Touch this button to choose Auto,Sleep and Continuous Dry mode.
3.	ADJ Button	Touch this button to adjust the humidity level and choose timer hour.
4.	Timer button	Touch this button to set a time for the unit to automatically start or stop.
5.	Fan speed button	Touch this button to select fan speed between high and low.
6.	Lock button	Hold this button to turn child lock function on or off.
7.	SWING	Press both TIMER and FAN button together to start Swing function.
8	Digital Display	Displays humidity value, Timer setting or Temperature.



Power button

In the standby state, Touch this button to turn on, the operation indicator lights up and the default fan speed is high, and the default humidity is 50%. In the power-on state, Touch this button to turn off, the running indicator light goes off and the compressor stops immediately, and then the fan shut down after 30 seconds delay.



Mode button

Touch the mode key to switch between automatic, Sleep and dry mode.

Automatic mode: when environmental humidity \geq set humidity +3%, the fan starts working and compressor starts working after 3 seconds.

When environmental humidity \leq set humidity -3%, the compressor stops working and fan stops working after 30 seconds' delay.

Touch ADJ"  button to adjust the humidity level from 30% to 80% in automatic mode.

Both fan speed and humidity can be adjusted under auto mode.

Drying mode: The compressor keeps working without control by humidity; Fan speed can be adjusted, but target humidity level can not.

Sleep Mode: Touch the sleep button, the button lights up and start the sleep function, default humidity is 60%. After no operation in 10 seconds, all indicators turn dark gradually and the fan speed is automatically switched low fan speed, press any button to wake up the indicator. Touch sleep button again to exit the sleep mode.

Both fan speed and humidity can be adjusted under sleep mode.



Timer button

Touch the timer button to set the 00-24 hour timing function. Display panel "88" flashes and will show timer hour, Touch ADJ"  button, the value increase 1 hour, the value displayed on the "88" display screen.

In the running state, use the timer function to turn off the machine regularly".

In the standby state, use the timer function to turn on the machine regularly".

Set the time to "00" to cancel the timing function.



Speed

High fan - low fan speed cycle, Touch the button once to switch and then the corresponding indicator lights up. In continuously drying mode, and defrosting period, the fan speed can not be changed.



FAN



TIMER

SWING

Swing

Press FAN and TIMER button at the same time to start auto swing function, press again to stop swing function.



Child lock

LOCK

Hold the child lock button to turn on or off the child lock function, the indicator  lights up when it is turned on.

Water Tank Full Alarm

Water Tank Indicator

●When the tank is full for 5 seconds, it sets the alarm. The water tank indicator turns red and the unit buzzes for 5 times.

Clear the alarm

●When the buzz is on, touch any button to stop it. The compressor, fan shut down and all the functions freeze until the tank is emptied and back in right position.

5.2 DRAINAGE

There are two ways of removal collected water produced by the unit.

A. Manual draining: Empty water tank by manual.

B. Continuous draining: Use gravity to drain condensate water by attaching a

drain hose.

5.2.1 EMPTYING THE WATER TANK

The water tank built in unit ,will fill up and shut the unit down once it is full. It will run again once you empty the water tank and installed properly.

- When the tank is full, The unit will make a buzzing sound, and the “Water Full” light will turn on.
- Touch the POWER button to turn off the unit.
- Pull on the water tank and simply slide out of the body of the dehumidifier.
- Empty the water into an area with a drain or outside.
- Clean the inside of the tank as well as the outside.
- Replace the empty tank back into the unit.
- Press the POWER button to resume operating.
- If the Water Full light does not extinguish, check that the float is correctly in place.

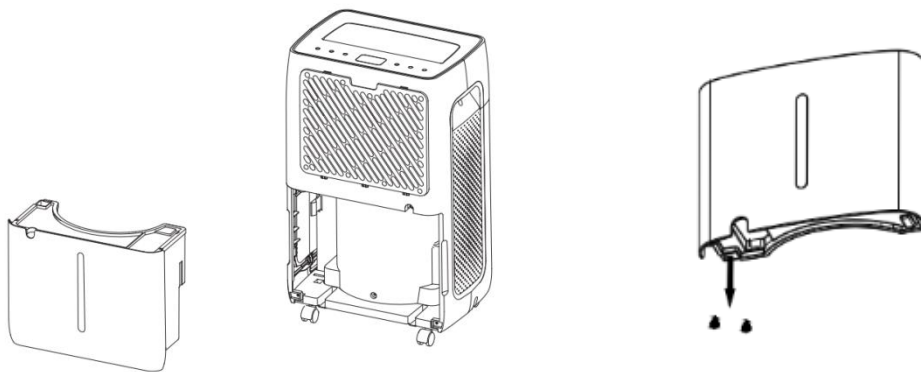

5.2.2 CONTINUOUS DRAINING

For continuous operation or unattended dehumidification, please connect the attached drain hose to the unit. Condensate water can be automatically flow into a bucket or drain by gravity.

- Set the unit in a horizontal surface and stable position.
- Switch off the unit before operating.
- Securely and properly connect the drain hose and make sure it is not kinked and clear of obstruction.

- Place the outlet of hose over a drain or bucket and ensure that water could freely flow out of the unit.

Do not submerge the end of hose into water; otherwise it can cause "Air Lock" in the hose.

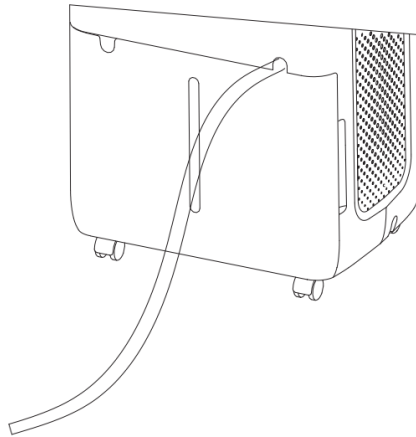

To avoid water spillage:

- As the negative pressure of condensate drain pan is large, tilt the drain hose downward toward the floor. It is appropriate that the degree of inclination should exceed 20 degrees.

Straighten the hose to avoid a trap existing in the hose.

6. MAINTENANCE

- **CLEANING THE AIR FILTER** (every two weeks)

Dust collects on the filter and restricts the airflow. The restricted airflow reduces the efficiency of the system and if it becomes blocked it can cause

damage to the unit.

The air filter requires regular cleaning. The air filter is removable for easy cleaning. Do not operate the unit without an air filter, or the evaporator may be contaminated.

1. Remove the filter frame and take off the filter.

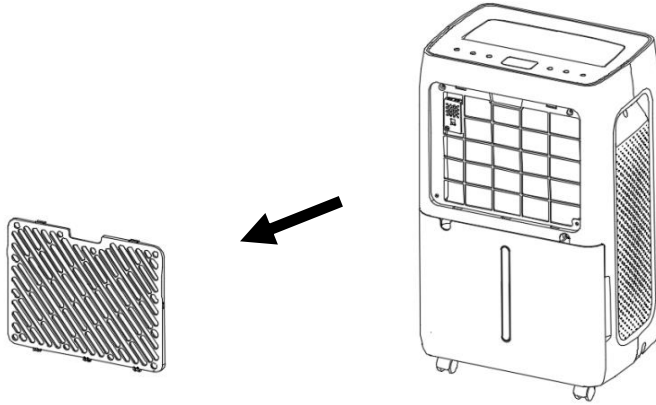

2. Soak the strainer in warm water at about 40 degrees Celsius. Rinse gently with a neutral detergent.

Use the vacuum cleaner's brush to gently remove dust from the screen.

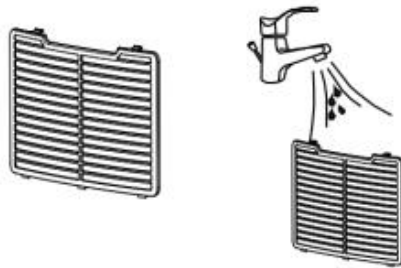

3. Put the filter back.

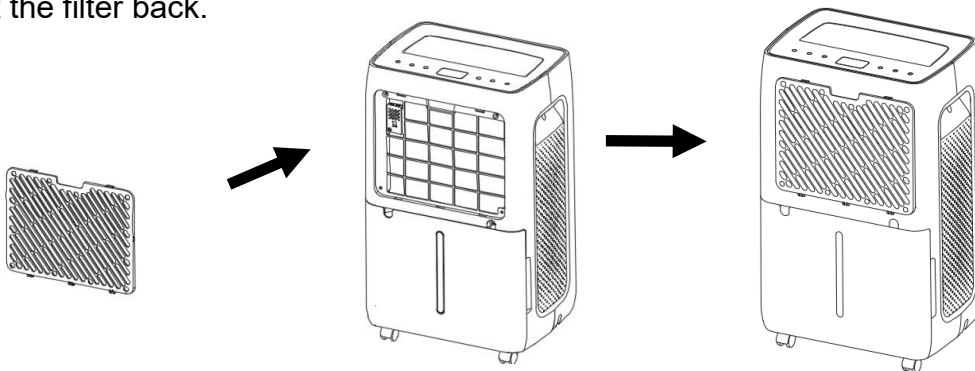

7.TROUBLE SHOOTING

1. FUNCTIONING TEMP.

5°C ≤ Ambient Temp. ≤ 38°C

When the ambient temp is lower or higher than the functioning temp, the dehumidifier stops.

When 5°C ≤ Ambient temp. ≤ 16°C, the compressor automatically defrosts at intervals; during defrosting, the compressor stops and the fan keeps running.

2.BEFORE CALLING FOR SERVICE

Before contacting professional service, please review the trouble shooting list that includes common occurrences that are not the result of a defect in workmanship or materials.

Problem	Possible Cause	Solution
Not working	No power supply	Connect to a functioning outlet and switch on
	Water Full Indication Flashes	Drain water tank and reset it, or re-position the water tank to right place
	Room temperature < 5°C, or > 38 °C	Self-Protection designed to protect the unit. Can not work under such temperature
Bad functioning	Is the air filter clogged?	Clean the air filter as instructed
	Is the intake duct or discharge duct obstructed?	Remove the obstruction from the discharge duct or intake duct.
No air intake	Is the filter clogged?	Wash the filter
Loud noise when running	Is the machine put in the plat place?	Put the machine on the plat ground
	Is the filter clogged?	Wash the filter
E1/E2	Humidity sensor problem	Change a sensor
LO	Environmental humidity is below 20%	The dehumidifier shuts down for self-protection
HI	Environmental humidity is above 90%	
CL	Low temperature protection, the environmental temperature < 5°C	
CH	High temperature protection, the environmental temperature > 38°C	

8. DECOMMISSIONING

8.1 STORAGE

Long-term storage - If you will not be using the unit for an extended period of time (more than a few weeks) it is best to clean the unit and dry it out completely. Please store the unit per the following steps:

1. Press power button to switch off and unplug the unit.
2. Drain the remaining water from the unit.
3. Clean the filter and let the filter dry completely in a shaded area.
4. Collect the power cord at the water tank.
5. Re-install the filter at its position.
6. The unit must be kept in upright position when in storage.
7. Preserving the machine in ventilating, dry, non- corrosive gas and safe place indoor.

ATTENTION:

The evaporator inside the machine has to be dried out before the unit is packed to avoid component damage and molds. Unplug the unit and place it in a dry open area for days to dry it out. Another way to dry the unit is to set the humidity point more than 5% higher than the ambient humidity to force the fan to dry the evaporator for a couple of hours.

8.2 DISPOSAL

WARNING!!!

Releasing refrigerant into atmosphere is strictly forbidden!

Do not dispose of electrical appliances as unsorted municipal waste, use separate collection facilities. Contact your local government for information regarding the collection systems available. If electrical appliances are disposed of in landfills or dumps, hazardous substances can leak into the groundwater and get into the food chain, damaging your health and well-being

