

FRANKLY
AMSTERDAM

PRICE LIST CONTRACT COLLECTION
April 2024

TERMS AND CONDITIONS

Our general terms and conditions of sales apply to all our agreements, quotations and offers. Please find a copy at www.frankly.amsterdam/salesconditions or at the Chambers of Commerce Amsterdam number 34393141. The terms and conditions used by the other party shall be explicitly excluded.

Every product made from a natural material is unique. Therefore a small difference in size or color may occur. We strongly advise not to expose fabrics of our indoor products to direct sunlight.

Frankly Amsterdam is owner of the goods until they have been completely paid.

PRICES

Prices to public are issued in euros, including VAT. The price per m2 does not include the shipping costs and installation costs.

SHIPPING

Goods travel at buyer's risk and danger: possible damages must be reported at delivery immediately. For transportation of our rugs we collaborate closely with shipping agencies specialised in high-end transportation. The rugs are shipped in rolls that have to be transported laying down, and can not be stacked underneath other cargo under any circumstance.

Because of this precise method of transportation, damages in transport rarely occurs. Despite this, we advise you to check the roll upon receipt for any damages. Please make sure to confirm that the packaging and the roll are both still in tact.

Any unexpected damages discovered upon arrival must be noted on the loading bill. Alongside this, Frankly Amsterdam wishes to receive notice of the damages, including pictures of the damaged packaging. After the client signs for completed delivery, there is no possibility to claim transport damages.

SHIPPING COSTS

Shipping costs vary per order depending on the number or rolls, size of the rolls, the country and the shipping method. Please see the overview on the next page.

DELIVERY

The delivery time of our tufted rugs is 6 weeks including transportation. The delivery time of our woven rugs and wall rugs is 8 weeks including transportation. The delivery date stated on the order confirmation is approximate and free of obligation. This shall not be considered to be a strict deadline unless a certain delivery date is explicitly guaranteed by Frankly Amsterdam.

For tufted rugs we can offer a quick delivery service. If the requested yarn is on stock, the rug can be shipped within 48 hours or 2 weeks. Feel free to contact us for the conditions and prices.

SHIPPING COSTS FOR RUGS (EXCL. VAT)

	NUMBER OF ROLLS PER ORDER	SMALL ROLL <160CM	MEDIUM ROLL 160-280CM	LARGE ROLL >280CM
AUSTRIA	1	€ 292,-	€ 316,-	€ 341,-
	2	€ 200,-	€ 219,-	€ 237,-
	3	€ 170,-	€ 186,-	€ 202,-
	4	€ 155,-	€ 170,-	€ 185,-
	5	€ 146,-	€ 160,-	€ 175,-
BELGIUM	1	€ 161,-	€ 174,-	€ 186,-
	2	€ 137,-	€ 150,-	€ 163,-
	3	€ 129,-	€ 142,-	€ 155,-
	4	€ 126,-	€ 138,-	€ 151,-
	5	€ 123,-	€ 136,-	€ 149,-
GERMANY	1	€ 247,-	€ 273,-	€ 298,-
	2	€ 181,-	€ 200,-	€ 219,-
	3	€ 158,-	€ 175,-	€ 192,-
	4	€ 147,-	€ 163,-	€ 179,-
	5	€ 140,-	€ 156,-	€ 171,-
THE NETHERLANDS	1	€ 155,-	€ 167,-	€ 180,-
	2	€ 134,-	€ 147,-	€ 160,-
	3	€ 127,-	€ 140,-	€ 153,-
	4	€ 124,-	€ 137,-	€ 149,-
	5	€ 122,-	€ 135,-	€ 147,-
SWITZERLAND	1	€ 305,-	€ 330,-	€ 355,-
	2	€ 209,-	€ 228,-	€ 247,-
	3	€ 177,-	€ 194,-	€ 211,-
	4	€ 161,-	€ 177,-	€ 193,-
	5	€ 152,-	€ 167,-	€ 182,-

For Switzerland the Customs Clearance costs per order are € 55,- (excl. VAT).

OTHER COUNTRIES Shipping costs on request

INDEX

This is an interactive price list.

By clicking on the product name, you will be directed to the product page.

By clicking on our logo you will return to this index.

CONTRACT COLLECTION

All Star

Day Off

Done Deal

Easy Going

Front Row

Good Life

High Tide

Lay Out

Line Up

Next Step

No Doubt

On Return

Out Line

Roll Over

Step Up 16

Step Up 9

EDGE FINISHING

SAMPLES

CARE INSTRUCTIONS

WARRANTY

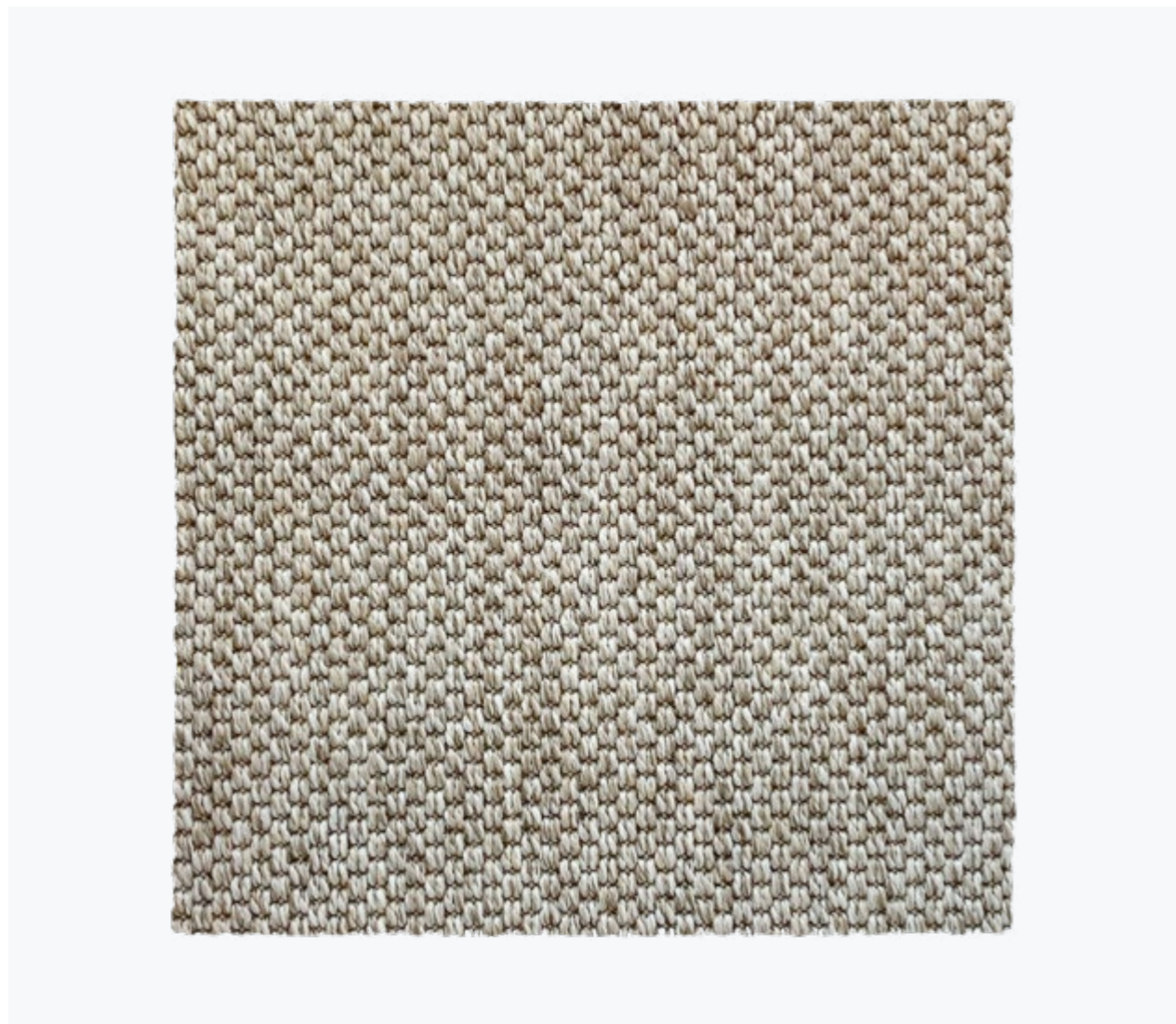

ALL STAR

Available as Rug, wall-to-wall, (stair)runner
 Pile surface Loop pile
 Pile composition 100% P.P.
 Size 4m width, up to 30m length
 Shape Rectangular
 Carpet weight ± 1.650 g/m²
 Carpet thickness ± 5 mm
 Backing Gel backing. Color 8801 and 8808 have a Precoat Latex backing
 Roll width 4 meter
 Fire classification Cfl-s1 / Efl for color 8801 and 8808
 Colors 11 standard
 Advantages
 + suitable for indoor and outdoor use
 + suitable for residential and contract
 + waterproof and UV proof
 + easy cleaning
 + castor proof



ALL STAR PRICE LIST

ARTICLE	ARTICLE CODE	COLOR	CUT LENGTH	FULL ROLL (120-136M2)**	RUG WITH OVERLOCK*	RUG WITH FOLDED PADDED EDGE*
Wall-to-wall or rug	ALS8801	8901	€ 139,- / m ²	€ 109,- / m ²	€ 209,- / m ²	€ 333,- / m ²
	ALS8802	8802	€ 139,- / m ²	€ 109,- / m ²	€ 209,- / m ²	€ 333,- / m ²
	ALS8803	8803	€ 139,- / m ²	€ 109,- / m ²	€ 209,- / m ²	€ 333,- / m ²
	ALS8804	8804	€ 139,- / m ²	€ 109,- / m ²	€ 209,- / m ²	€ 333,- / m ²
	ALS8805	8805	€ 139,- / m ²	€ 109,- / m ²	€ 209,- / m ²	€ 333,- / m ²
	ALS8806	8806	€ 139,- / m ²	€ 109,- / m ²	€ 209,- / m ²	€ 333,- / m ²
	ALS8807	8807	€ 139,- / m ²	€ 109,- / m ²	€ 209,- / m ²	€ 333,- / m ²
	ALS8808	8808	€ 139,- / m ²	€ 109,- / m ²	€ 209,- / m ²	€ 333,- / m ²
	ALS8809	8809	€ 139,- / m ²	€ 109,- / m ²	€ 209,- / m ²	€ 333,- / m ²
	ALS8810	8810	€ 139,- / m ²	€ 109,- / m ²	€ 209,- / m ²	€ 333,- / m ²
	ALS8811	8811	€ 139,- / m ²	€ 109,- / m ²	€ 209,- / m ²	€ 333,- / m ²

Your order will be cut from a roll of 4 meters width. Please include the cutting loss in your order. If you need any help calculating this, we are glad to be of service.

* Click here to see the overview page with our edge finishing options.

Rugs with a folded padded edge will have felted padding at the bottom, therefore they can only be used indoors and can not be used for stair runners. Please calculate a 10 cm margin around all edges for a rug with folded padded edge. Max. rug width for this finish is 380 cm.

** Only complete rolls can be purchased. Roll lengths vary from 120-136m². Please contact us for the lengths of the rolls.

PLEASE NOTE! Prices shown are public prices including VAT. Please inform for your purchase conditions. The price per m² does not include installation and shipping costs. Click here to see the overview of shipping costs per country (page 3).

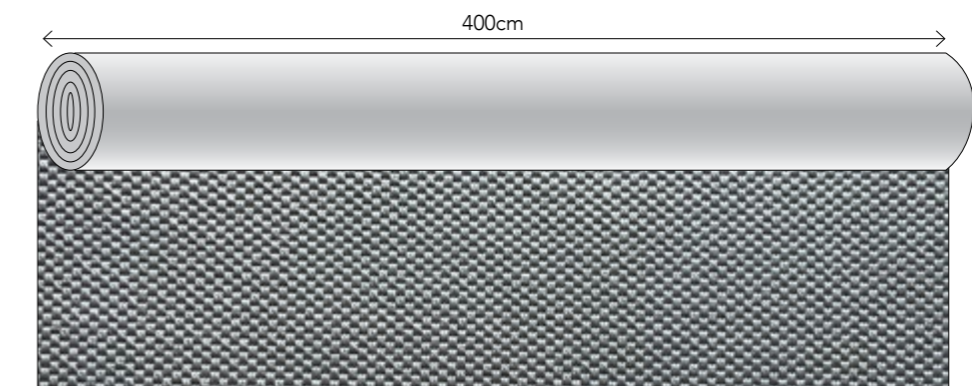

This pattern is not on scale, this image only shows the pattern direction

The cutting and seaming together of a flatweave is a precise and time consuming process with the resulting join likely to be variable in appearance. The durability of seams cannot be guaranteed in multi-width installations, therefore we do not recommend side-to-side or end-to-end joins in a flatweave product. In case seams are desired, it is advisable to use a metal binding strip in case of head seams OR use a carpet seam sealer to seal the edges after cutting.

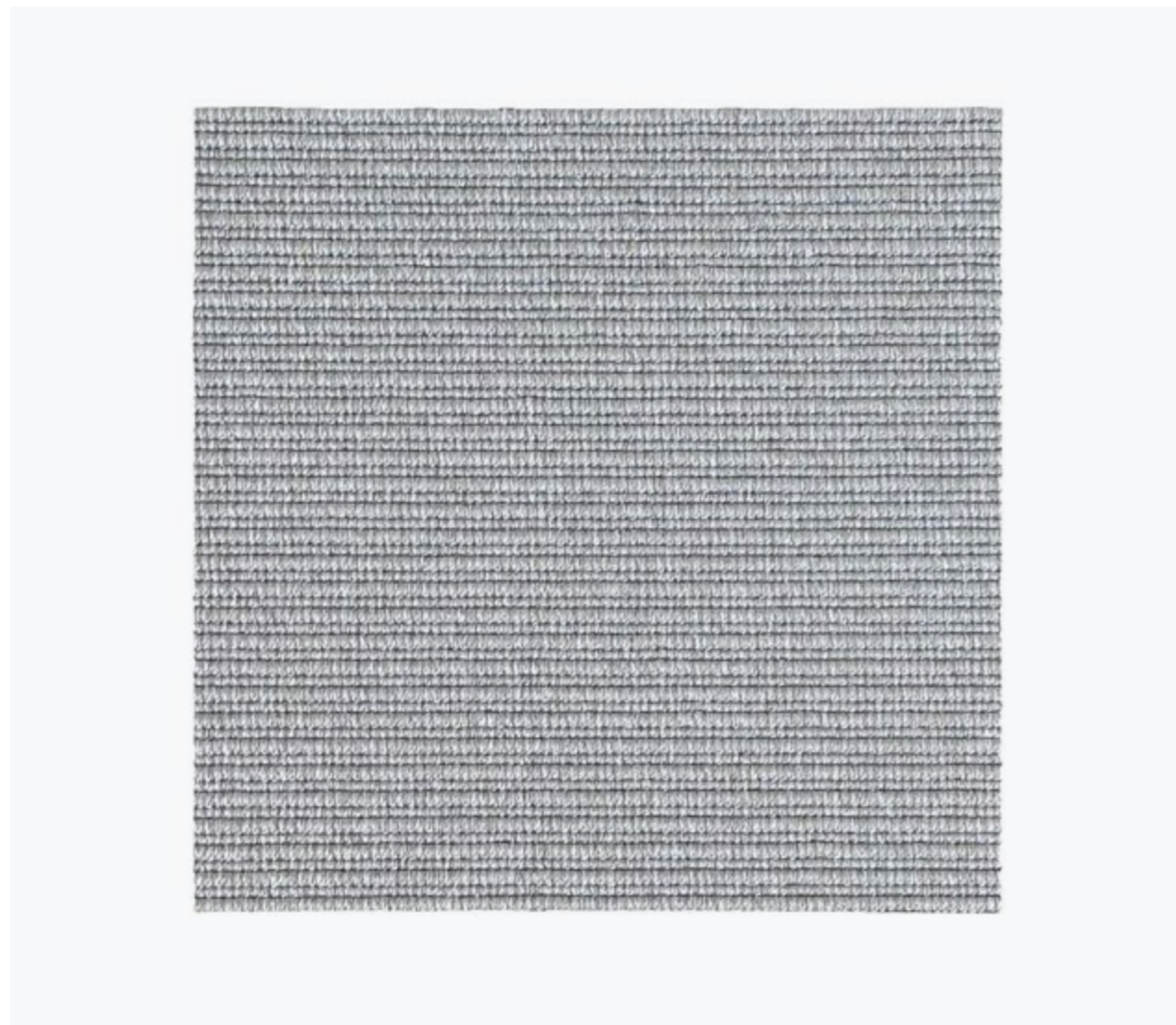

DAY OFF

Available as Rug, wall-to-wall, (stair)runner
 Pile surface Loop pile
 Pile composition 100% Recycled PET
 Size Maximum 4m width, up to 32m length
 Shape Rectangular or circular
 Carpet weight ± 2.600 g/m²
 Carpet thickness ± 4 mm
 Backing P.P. + Latex
 Roll width 2 or 4 meter
 Fire classification Dfl-s1
 Colors 4 standard colors
 Advantages
 + suitable for indoor and outdoor use
 + suitable for residential and contract
 + available as rug, wall-to-wall carpet and stair runner
 + waterproof and UV proof
 + easy cleaning, even with diluted bleach
 + castor proof



DAY OFF PRICE LIST

ARTICLE	ARTICLE CODE	COLOR	CUT LENGTH	FULL ROLL (100-150M2)**	RUG WITH OVERLOCK*	RUG WITH BORDER*
Wall-to-wall or rug	DAO7201	7201	€ 165,- / m ²	€ 145,- / m ²	€ 235,- / m ²	€ 299,- / m ²
	DAO7202	7202	€ 165,- / m ²	€ 145,- / m ²	€ 235,- / m ²	€ 299,- / m ²
	DAO7203	7203	€ 165,- / m ²	€ 145,- / m ²	€ 235,- / m ²	€ 299,- / m ²
	DAO7204	7204	€ 165,- / m ²	€ 145,- / m ²	€ 235,- / m ²	€ 299,- / m ²

Your rug will be cut from a roll of 2 meters or 4 meters width. Please take cutting loss into account, in case the requested rug size is smaller than the width of the roll. If you need any help with calculations, we are glad to be of service.

Depending on your requested size, a roll of 2 meters or 4 meters width will be selected for cutting. The roll width of 2 meters is available up to 7,5 linear meters maximum. All orders that require an amount of linear meters above 7,5 meter will be cut from a roll of 4 meters width.

* [Click here to see the overview page with our edge finishing options.](#)

** Only complete rolls can be purchased. Roll lengths vary from 100-150m². Please contact us for the lengths of the rolls.

PLEASE NOTE! Prices shown are public prices including VAT and do not include the shipping costs. This product is always rolled in the roll width direction to maintain its structural integrity. Please note that this can affect the transportation costs, depending on the size of the rug. [Click here to see the overview of shipping costs per country \(page 3\).](#)

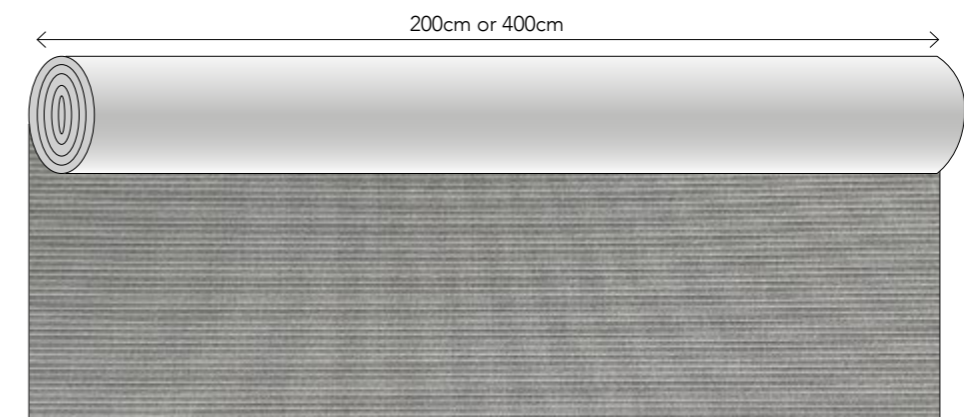

This pattern is not on scale, this image only shows the pattern direction

The cutting and seaming together of a flatweave is a precise and time consuming process with the resulting join likely to be variable in appearance. The durability of seams cannot be guaranteed in multi-width installations, therefore we do not recommend side-to-side or end-to-end joins in a flatweave product. In case seams are desired, it is advisable to use a metal binding strip in case of head seams OR use a carpet seam sealer to seal the edges after cutting.



DONE DEAL

Available as	Wall-to-wall
Pile surface	Cut Pile
Pile composition	50% Wool + 50% Eucalyptus
Carpet weight	± 3.500 g/m ²
Pile height	± 12 mm
Carpet thickness	± 13,5 mm
Backing	Natural latex + anti-slip
Fire classification	Cfl-s1
Colors	9 standard, custom colors available on request
Edge finishing	This wall-to-wall rug has no edge finishing
Advantages	+ suitable for residential as well as soft contract + available as stair runner + long-lasting + custom colors available



DONE DEAL PRICE LIST

ARTICLE	ARTICLE CODE	COLOR	24 M ² OR MORE *
Wall-to-wall	DOD7001	7001	€ 440,- / m ²
	DOD7002	7002	€ 440,- / m ²
	DOD7003	7003	€ 440,- / m ²
	DOD7004	7004	€ 440,- / m ²
	DOD7005	7005	€ 440,- / m ²
	DOD7006	7006	€ 440,- / m ²
	DOD7007	7007	€ 440,- / m ²
	DOD7008	7008	€ 440,- / m ²
	DOD7009	7009	€ 440,- / m ²

* This product can only be ordered from 24 m² per color.

PLEASE NOTE! Prices shown are public prices including VAT. Please inform for your purchase conditions. The price per m² does not include installation and shipping costs. [Click here to see the overview of shipping costs per country \(page 3\).](#)

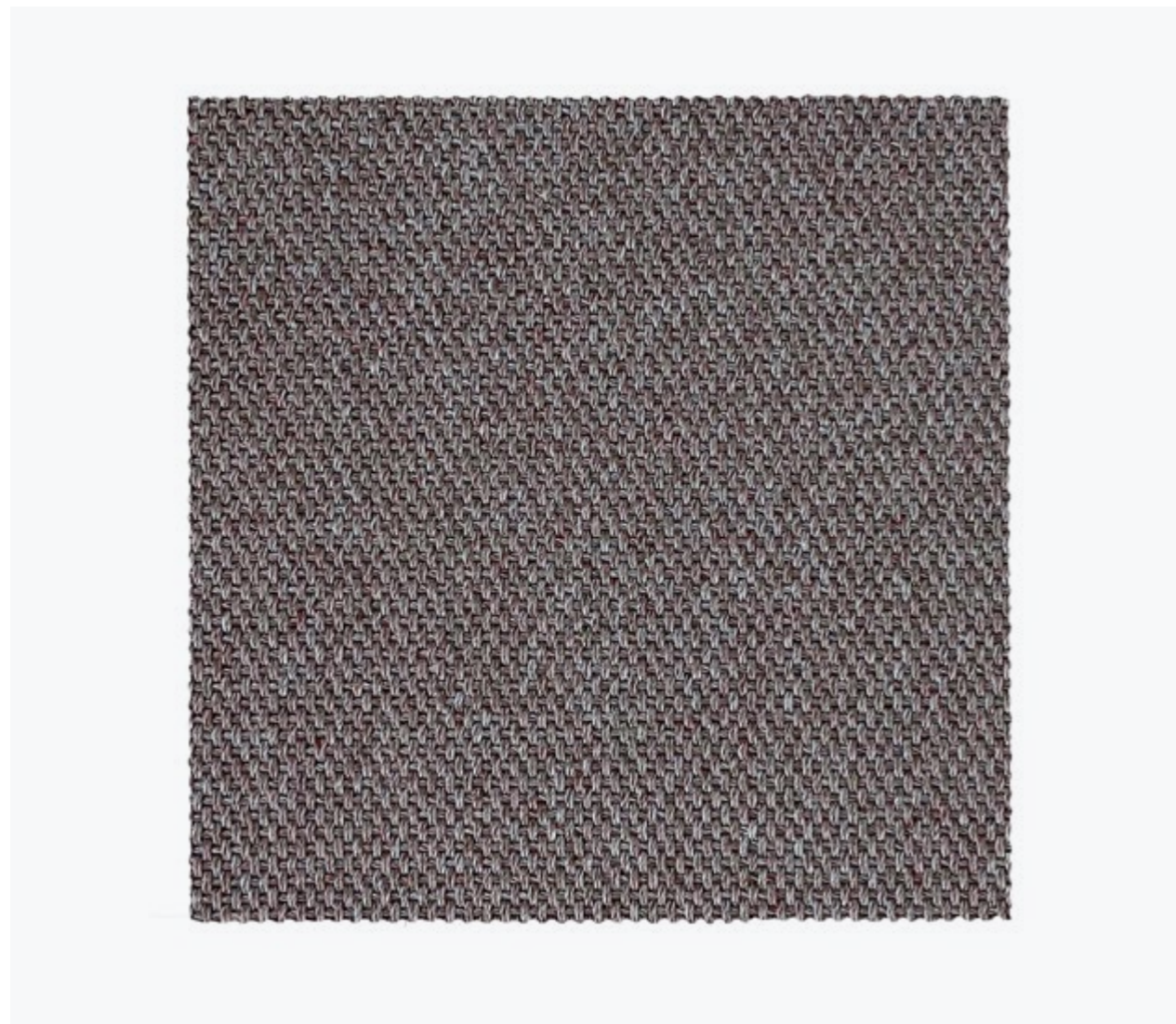

EASY GOING

Available as Rug, wall-to-wall, (stair)runner
 Pile surface Loop pile
 Pile composition 100% Recycled PET
 Size Maximum 4m width, up to 32m length
 Shape Rectangular or circular
 Carpet weight ± 2.400 g/m²
 Carpet thickness ± 4 mm
 Backing P.P. + Latex
 Roll width 2 or 4 meter
 Fire classification Dfl-s1
 Colors 6 standard
 Advantages
 + suitable for indoor and outdoor use
 + suitable for residential and contract
 + available as rug, wall-to-wall carpet and stair runner
 + waterproof and UV proof
 + easy cleaning, even with diluted bleach
 + castor proof



EASY GOING PRICE LIST

ARTICLE	ARTICLE CODE	COLOR	CUT LENGTH	FULL ROLL (100-150M2)**	RUG WITH OVERLOCK*	RUG WITH BORDER*
Wall-to-wall or rug	EAG7401	7401	€ 165,- / m ²	€ 145,- / m ²	€ 235,- / m ²	€ 299,- / m ²
	EAG7402	7402	€ 165,- / m ²	€ 145,- / m ²	€ 235,- / m ²	€ 299,- / m ²
	EAG7403	7403	€ 165,- / m ²	€ 145,- / m ²	€ 235,- / m ²	€ 299,- / m ²
	EAG7404	7404	€ 165,- / m ²	€ 145,- / m ²	€ 235,- / m ²	€ 299,- / m ²
	EAG7405	7405	€ 165,- / m ²	€ 145,- / m ²	€ 235,- / m ²	€ 299,- / m ²
	EAG7406	7406	€ 165,- / m ²	€ 145,- / m ²	€ 235,- / m ²	€ 299,- / m ²

Your rug will be cut from a roll of 2 meters or 4 meters width. Please take cutting loss into account, in case the requested rug size is smaller than the width of the roll. If you need any help with calculations, we are glad to be of service.

Depending on your requested size, a roll of 2 meters or 4 meters width will be selected for cutting. The roll width of 2 meters is available up to 7,5 linear meters maximum. All orders that require an amount of linear meters above 7,5 meter will be cut from a roll of 4 meters width.

* [Click here to see the overview page with our edge finishing options.](#)

** Only complete rolls can be purchased. Roll lengths vary from 100-150m². Please contact us for the lengths of the rolls.

PLEASE NOTE! Prices shown are public prices including VAT and do not include the shipping costs. This product is always rolled in the roll width direction to maintain its structural integrity. Please note that this can affect the transportation costs, depending on the size of the rug.

[Click here to see the overview of shipping costs per country \(page 3\).](#)

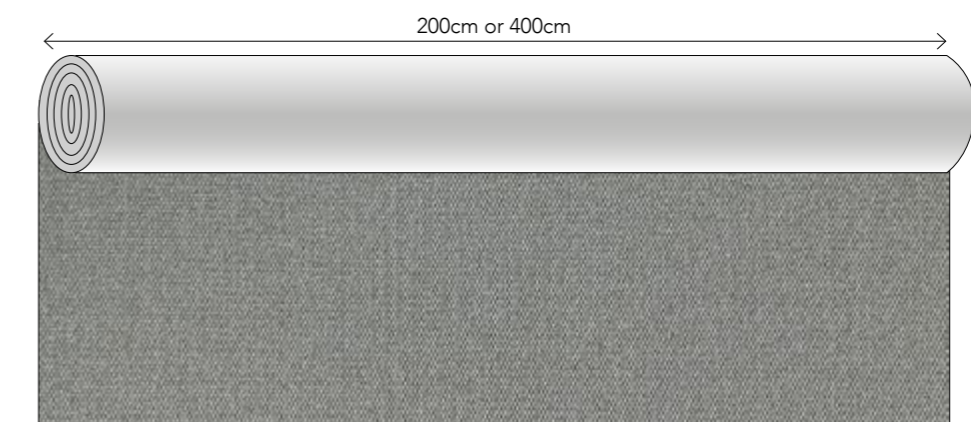

This pattern is not on scale, this image only shows the pattern direction

The cutting and seaming together of a flatweave is a precise and time consuming process with the resulting join likely to be variable in appearance. The durability of seams cannot be guaranteed in multi-width installations, therefore we do not recommend side-to-side or end-to-end joins in a flatweave product. In case seams are desired, it is advisable to use a metal binding strip in case of head seams OR use a carpet seam sealer to seal the edges after cutting.

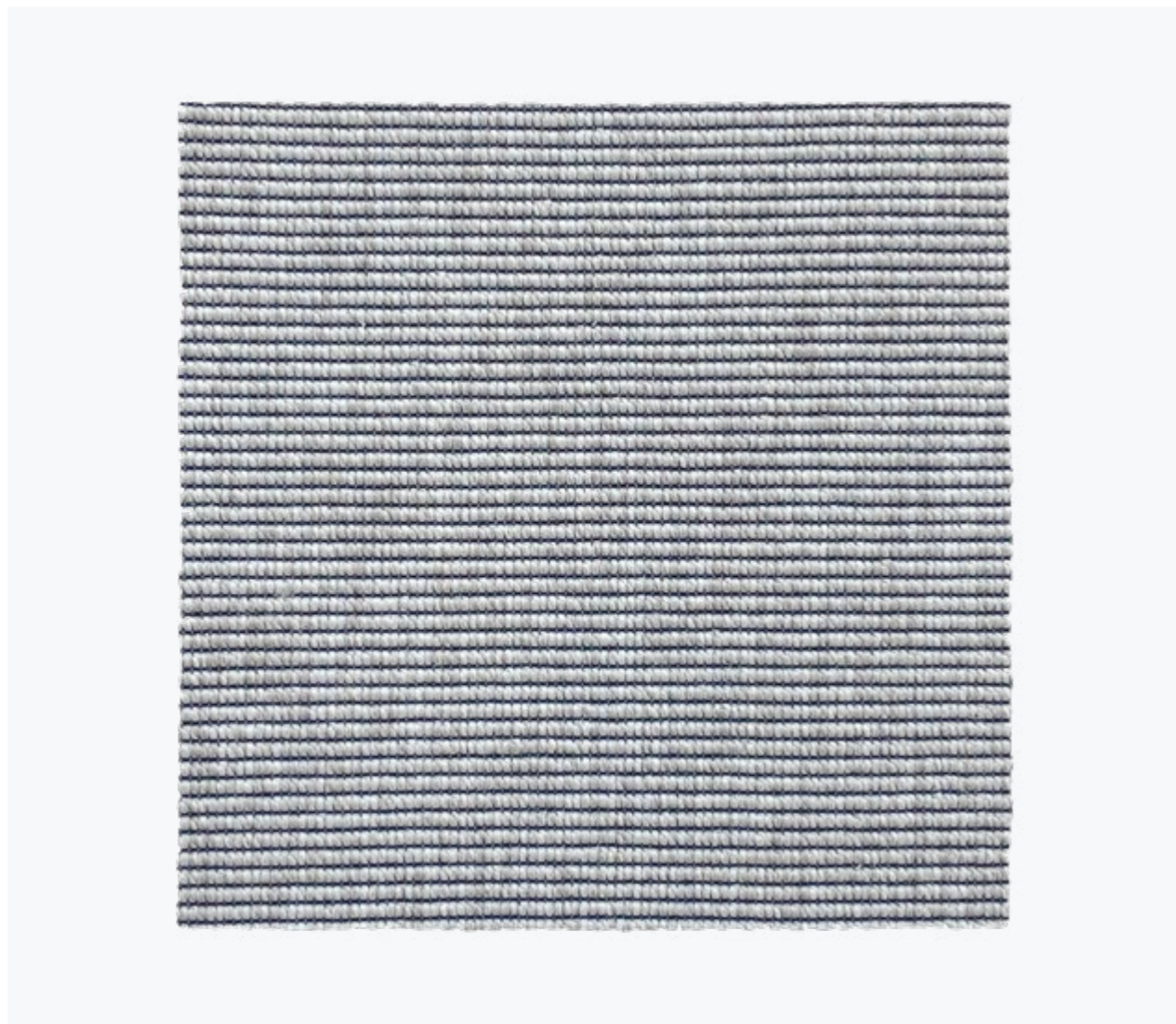

FRONT ROW

Available as Rug, wall-to-wall, (stair)runner
 Pile surface Loop pile
 Pile composition 100% P.P.
 Size 4m width, up to 30m length
 Shape Rectangular or circular
 Carpet weight ± 1.650 g/m²
 Carpet thickness ± 4 mm
 Backing Gel backing
 Roll width 4 meter
 Fire classification Cfl-s1
 Colors 8 standard
 Advantages
 + suitable for indoor and outdoor use
 + suitable for residential and contract
 + waterproof and UV proof
 + easy cleaning
 + castor proof



FRONT ROW PRICE LIST

ARTICLE	ARTICLE CODE	COLOR	CUT LENGTH	FULL ROLL (120-136M2)**	RUG WITH OVERLOCK*	RUG WITH FOLDED PADDED EDGE*
Wall-to-wall or rug	FRR8901	8901	€ 139,- / m ²	€ 109,- / m ²	€ 209,- / m ²	€ 333,- / m ²
	FRR8902	8902	€ 139,- / m ²	€ 109,- / m ²	€ 209,- / m ²	€ 333,- / m ²
	FRR8903	8903	€ 139,- / m ²	€ 109,- / m ²	€ 209,- / m ²	€ 333,- / m ²
	FRR8904	8904	€ 139,- / m ²	€ 109,- / m ²	€ 209,- / m ²	€ 333,- / m ²
	FRR8905	8905	€ 139,- / m ²	€ 109,- / m ²	€ 209,- / m ²	€ 333,- / m ²
	FRR8906	8906	€ 139,- / m ²	€ 109,- / m ²	€ 209,- / m ²	€ 333,- / m ²
	FRR8907	8907	€ 139,- / m ²	€ 109,- / m ²	€ 209,- / m ²	€ 333,- / m ²
	FRR8908	8908	€ 139,- / m ²	€ 109,- / m ²	€ 209,- / m ²	€ 333,- / m ²

Your order will be cut from a roll of 4 meters width. Please include the cutting loss in your order. If you need any help calculating this, we are glad to be of service.

* [Click here to see the overview page with our edge finishing options.](#)

Rugs with a folded padded edge will have felted padding at the bottom, therefore they can only be used indoors and can not be used for stair runners. Please calculate a 10 cm margin around all edges for a rug with folded padded edge. Maximum rug width for this finish is 380 cm.

** Only complete rolls can be purchased. Roll lengths vary from 120-136m². Please contact us for the lengths of the rolls.

PLEASE NOTE! Prices shown are public prices including VAT. Please inform for your purchase conditions. The price per m² does not include installation and shipping costs. [Click here to see the overview of shipping costs per country \(page 3\).](#)

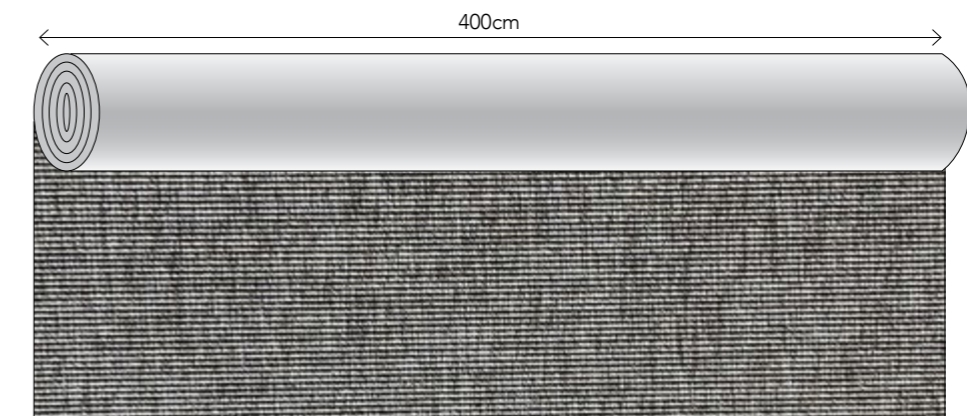

This pattern is not on scale, this image only shows the pattern direction

The cutting and seaming together of a flatweave is a precise and time consuming process with the resulting join likely to be variable in appearance. The durability of seams cannot be guaranteed in multi-width installations, therefore we do not recommend side-to-side or end-to-end joins in a flatweave product. In case seams are desired, it is advisable to use a metal binding strip in case of head seams OR use a carpet seam sealer to seal the edges after cutting.



GOOD LIFE

- Available as Rug, wall-to-wall, (stair)runner
- Pile surface Loop pile
- Pile composition 100% Recycled PET
- Size 4m width, up to 32m length
- Shape Rectangular or circular
- Carpet weight ± 2.300 g/m²
- Carpet thickness ± 4 mm
- Backing P.P. + Latex
- Roll width 2 or 4 meter
- Fire classification Dfl-s1
- Colors 4 standard
- Advantages
 - + suitable for indoor and outdoor use
 - + suitable for residential and contract
 - + available as rug, wall-to-wall carpet and stair runner
 - + waterproof and UV proof
 - + easy cleaning, even with diluted bleach
 - + castor proof



GOOD LIFE PRICE LIST

ARTICLE	ARTICLE CODE	COLOR	CUT LENGTH	FULL ROLL (100-150M2)**	RUG WITH OVERLOCK*	RUG WITH BORDER*
Wall-to-wall or rug	GOL7301	7301	€ 165,- / m ²	€ 145,- / m ²	€ 235,- / m ²	€ 299,- / m ²
	GOL7302	7302	€ 165,- / m ²	€ 145,- / m ²	€ 235,- / m ²	€ 299,- / m ²
	GOL7303	7303	€ 165,- / m ²	€ 145,- / m ²	€ 235,- / m ²	€ 299,- / m ²
	GOL7304	7304	€ 165,- / m ²	€ 145,- / m ²	€ 235,- / m ²	€ 299,- / m ²

Your rug will be cut from a roll of 2 meters or 4 meters width. Please take cutting loss into account, in case the requested rug size is smaller than the width of the roll. If you need any help with calculations, we are glad to be of service.

Depending on your requested size, a roll of 2 meters or 4 meters width will be selected for cutting. The roll width of 2 meters is available up to 7,5 linear meters maximum. All orders that require an amount of linear meters above 7,5 meter will be cut from a roll of 4 meters width.

* [Click here to see the overview page with our edge finishing options.](#)

** Only complete rolls can be purchased. Roll lengths vary from 100-150m². Please contact us for the lengths of the rolls.

PLEASE NOTE! Prices shown are public prices including VAT and do not include the shipping costs. This product is always rolled in the roll width direction to maintain its structural integrity. Please note that this can affect the transportation costs, depending on the size of the rug. [Click here to see the overview of shipping costs per country \(page 3\).](#)

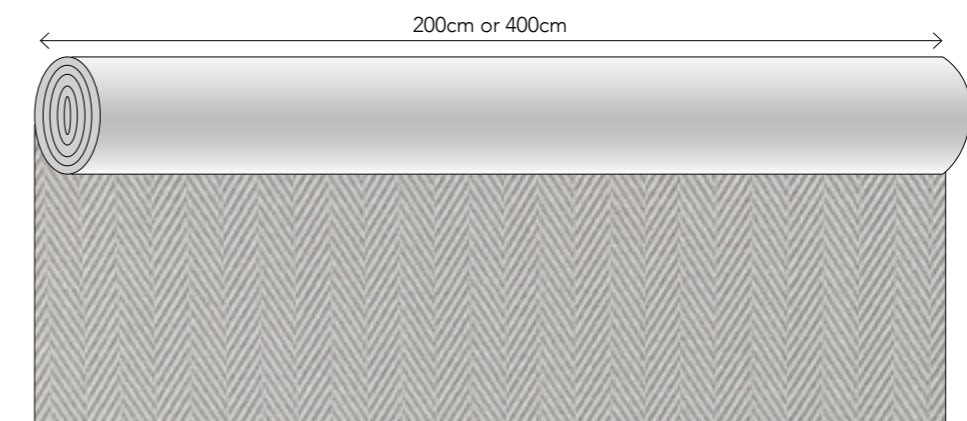

This pattern is not on scale, this image only shows the pattern direction

The cutting and seaming together of a flatweave is a precise and time consuming process with the resulting join likely to be variable in appearance. The durability of seams cannot be guaranteed in multi-width installations, therefore we do not recommend side-to-side or end-to-end joins in a flatweave product. In case seams are desired, it is advisable to use a metal binding strip in case of head seams OR use a carpet seam sealer to seal the edges after cutting.



HIGH TIDE

- Available as Rug, wall-to-wall, (stair)runner
- Pile surface Loop pile
- Pile composition 100% Recycled PET
- Size Maximum 4m width, up to 32m length
- Shape Rectangular or circular
- Carpet weight ± 2.600 g/m²
- Carpet thickness ± 4 mm
- Backing P.P. + Latex
- Roll width 2 or 4 meter
- Fire classification Dfl-s1
- Colors 4 standard
- Advantages
 - + suitable for indoor and outdoor use
 - + suitable for residential and contract
 - + waterproof and UV proof
 - + easy cleaning, even with diluted bleach
 - + castor proof

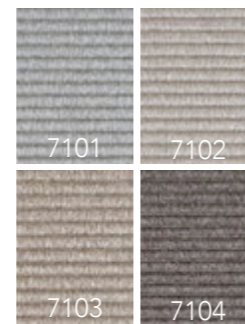

HIGH TIDE PRICE LIST

ARTICLE	ARTICLE CODE	COLOR	CUT LENGTH	FULL ROLL (100-150M2)**	RUG WITH OVERLOCK*	RUG WITH BORDER*
Wall-to-wall or rug	HIT7101	7101	€ 165,- / m ²	€ 145,- / m ²	€ 235,- / m ²	€ 299,- / m ²
	HIT7102	7102	€ 165,- / m ²	€ 145,- / m ²	€ 235,- / m ²	€ 299,- / m ²
	HIT7103	7103	€ 165,- / m ²	€ 145,- / m ²	€ 235,- / m ²	€ 299,- / m ²
	HIT7104	7104	€ 165,- / m ²	€ 145,- / m ²	€ 235,- / m ²	€ 299,- / m ²

Your rug will be cut from a roll of 2 meters or 4 meters width. Please take cutting loss into account, in case the requested rug size is smaller than the width of the roll. If you need any help with calculations, we are glad to be of service.

Depending on your requested size, a roll of 2 meters or 4 meters width will be selected for cutting. The roll width of 2 meters is available up to 7,5 linear meters maximum. All orders that require an amount of linear meters above 7,5 meter will be cut from a roll of 4 meters width.

* [Click here to see the overview page with our edge finishing options.](#)

** Only complete rolls can be purchased. Roll lengths vary from 100-150m². Please contact us for the lengths of the rolls.

PLEASE NOTE! Prices shown are public prices including VAT and do not include the shipping costs. This product is always rolled in the roll width direction to maintain its structural integrity. Please note that this can affect the transportation costs, depending on the size of the rug. [Click here to see the overview of shipping costs per country \(page 3\).](#)

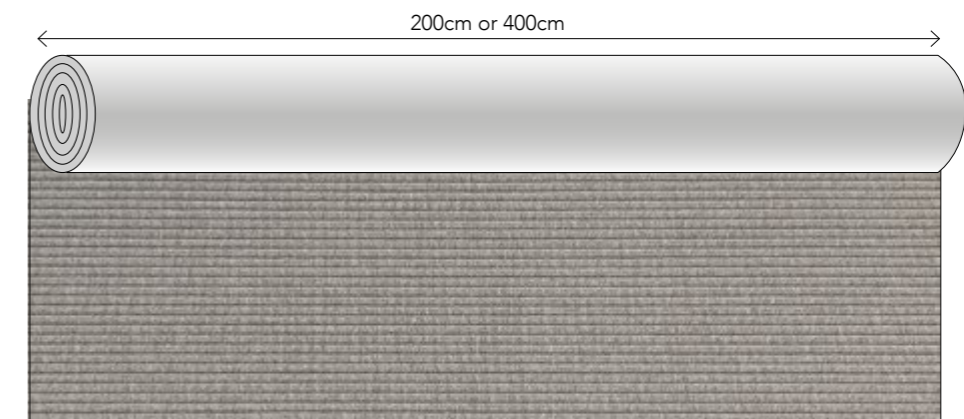

This pattern is not on scale, this image only shows the pattern direction

The cutting and seaming together of a flatweave is a precise and time consuming process with the resulting join likely to be variable in appearance. The durability of seams cannot be guaranteed in multi-width installations, therefore we do not recommend side-to-side or end-to-end joins in a flatweave product. In case seams are desired, it is advisable to use a metal binding strip in case of head seams OR use a carpet seam sealer to seal the edges after cutting.



LAY OUT

Available as	Rug, runner
Pile surface	Loop pile
Pile composition	100% Wool
Size	Maximum 4m width, up to 32m length
Shape	Any shape possible
Carpet weight	± 2.700 g/m ²
Carpet thickness	± 7 mm
Backing	Jute & cotton
Roll width	4 meters
Fire classification	Bfl-s1
Colors	4 standard colors
Advantages	+ suitable for heavy domestic use and soft contract + durable and hypoallergenic properties + natural backing with jute and cotton + custom shape possible



LAY OUT PRICE LIST

ARTICLE	ARTICLE CODE	COLOR	PRICE P/M ² WITH OVERLOCK EDGE*
Rug	LAO1601	1601	€ 335,-
	LAO1602	1602	€ 335,-
	LAO1603	1603	€ 335,-
	LAO1604	1604	€ 335,-

Your rug will be cut from a roll of 4 meters width. Please take cutting loss into account, in case the requested rug size is smaller than the width of the roll. If you need any help with calculations, we are glad to be of service.

* [Click here to see the overview page with our edge finishing options.](#)

PLEASE NOTE! Prices shown are public prices including VAT and do not include the shipping costs. [Click here to see the overview of shipping costs per country \(page 3\).](#) This product is always rolled in the roll width direction to maintain its structural integrity. Please note that this can affect the transportation costs, depending on the size of the rug.



This pattern is not on scale, this image only shows the pattern direction



LINE UP

Available as	Rug, runner
Pile surface	Loop pile
Pile composition	100% Wool
Size	Maximum 4m width, up to 32m length
Shape	Any shape possible
Carpet weight	± 2.700 g/m ²
Carpet thickness	± 7 mm
Backing	Jute & cotton
Roll width	4 meters
Fire classification	Bfl-s1
Colors	4 standard colors
Advantages	+ suitable for heavy domestic use and soft contract + durable and hypoallergenic properties + natural backing with jute and cotton + custom shape possible



LINE UP PRICE LIST

ARTICLE	ARTICLE CODE	COLOR	PRICE P/M ² WITH OVERLOCK EDGE*
Rug	LIP1701	1701	€ 335,-
	LIP1702	1702	€ 335,-
	LIP1703	1703	€ 335,-
	LIP1704	1704	€ 335,-

Your rug will be cut from a roll of 4 meters width. Please take cutting loss into account, in case the requested rug size is smaller than the width of the roll. If you need any help with calculations, we are glad to be of service.

* [Click here to see the overview page with our edge finishing options.](#)

PLEASE NOTE! Prices shown are public prices including VAT and do not include the shipping costs. [Click here to see the overview of shipping costs per country \(page 3\).](#) This product is always rolled in the roll width direction to maintain its structural integrity. Please note that this can affect the transportation costs, depending on the size of the rug.

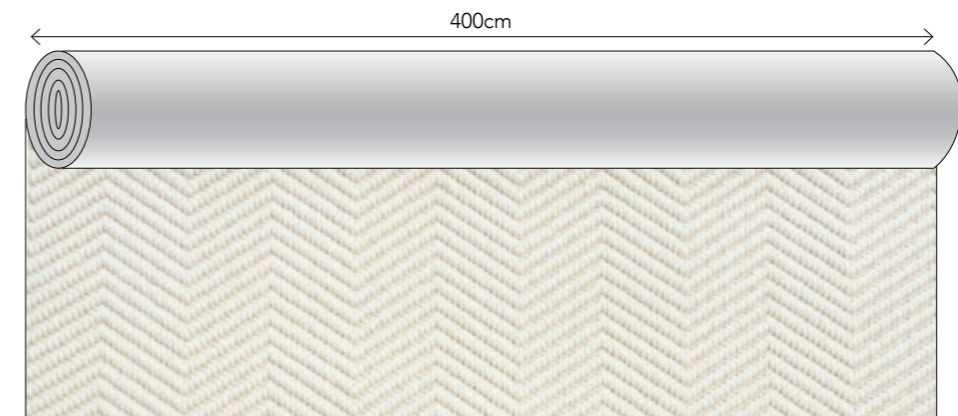

This pattern is not on scale, this image only shows the pattern direction



NEXT STEP

Available as Rug, wall-to-wall, (stair)runner
 Pile surface Loop pile
 Pile composition 100% P.P.
 Size 4m width, up to 30m length
 Shape Rectangular or circular
 Carpet weight ± 1.900 g/m²
 Carpet thickness ± 5 mm
 Backing Gel backing
 Roll width 4 meter
 Fire classification Cfl-s1
 Colors 5 standard
 Advantages
 + suitable for indoor and outdoor use
 + suitable for residential and contract
 + waterproof and UV proof
 + easy cleaning
 + castor proof

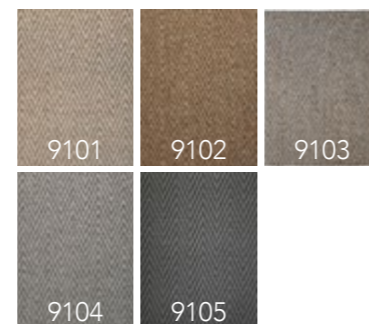

NEXT STEP PRICE LIST

ARTICLE	ARTICLE CODE	COLOR	CUT LENGTH	FULL ROLL (120-136M2)**	RUG WITH OVERLOCK*	RUG WITH FOLDED PADDED EDGE*
Wall-to-wall or rug	NES9101	9101	€ 159,- / m ²	€ 129,- / m ²	€ 222,- / m ²	€ 339,- / m ²
	NES9102	9102	€ 159,- / m ²	€ 129,- / m ²	€ 222,- / m ²	€ 339,- / m ²
	NES9103	9103	€ 159,- / m ²	€ 129,- / m ²	€ 222,- / m ²	€ 339,- / m ²
	NES9104	9104	€ 159,- / m ²	€ 129,- / m ²	€ 222,- / m ²	€ 339,- / m ²
	NES9105	9105	€ 159,- / m ²	€ 129,- / m ²	€ 222,- / m ²	€ 339,- / m ²

Your order will be cut from a roll of 4 meters width. Please include the cutting loss in your order. If you need any help calculating this, we are glad to be of service.

*** Click here to see the overview page with our edge finishing options.**

Rugs with a folded padded edge will have felted padding at the bottom, therefore they can only be used indoors and can not be used for stair runners. Please calculate a 10 cm margin around all edges for a rug with folded padded edge. Maximum rug width for this finish is 380 cm.

** Only complete rolls can be purchased. Roll lengths vary from 120-136m². Please contact us for the lengths of the rolls.

PLEASE NOTE! Prices shown are public prices including VAT. Please inform for your purchase conditions. The price per m² does not include installation and shipping costs. [Click here to see the overview of shipping costs per country \(page 3\).](#)

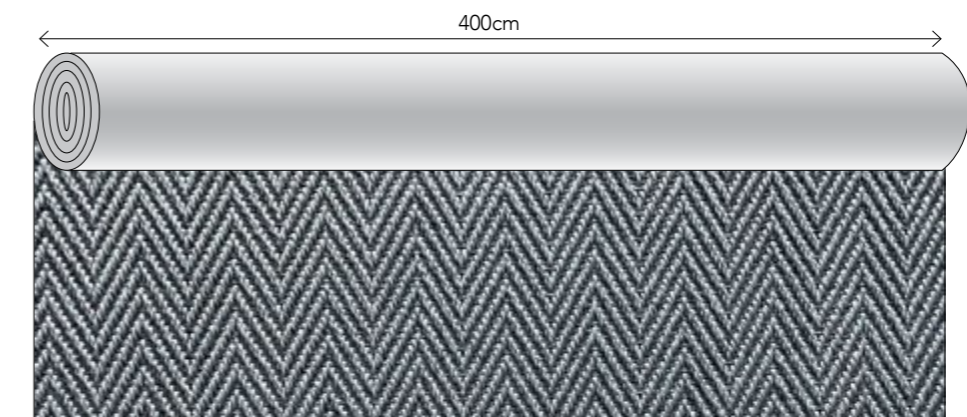

This pattern is not on scale, this image only shows the pattern direction

The cutting and seaming together of a flatweave is a precise and time consuming process with the resulting join likely to be variable in appearance. The durability of seams cannot be guaranteed in multi-width installations, therefore we do not recommend side-to-side or end-to-end joins in a flatweave product. In case seams are desired, it is advisable to use a metal binding strip in case of head seams OR use a carpet seam sealer to seal the edges after cutting.

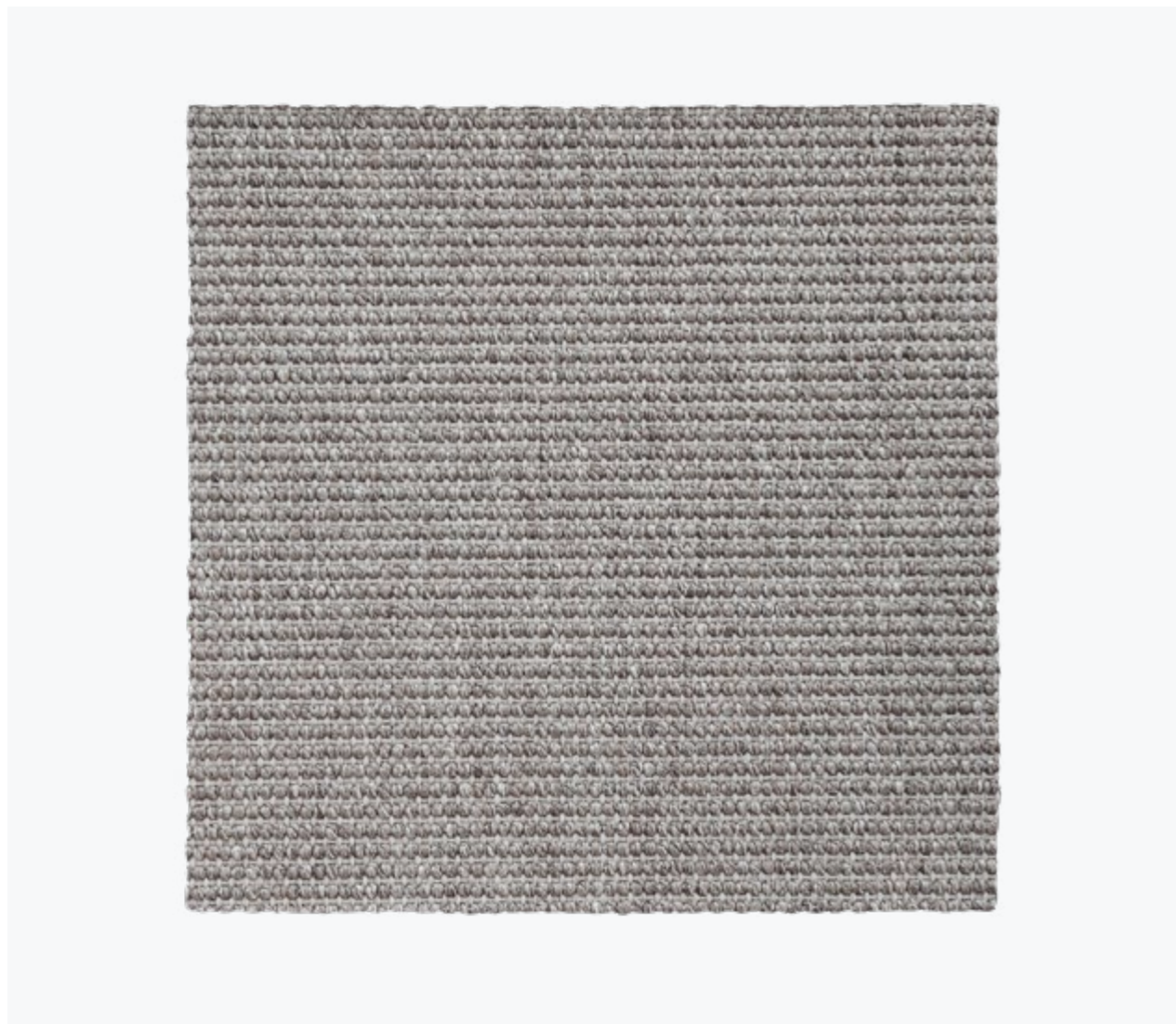

NO DOUBT

- Available as Rug, wall-to-wall, (stair)runner
- Pile surface Loop pile
- Pile composition 100% P.P.
- Size 4m width, up to 30m length
- Shape Rectangular or circular
- Carpet weight ± 1.950 g/m²
- Carpet thickness ± 5 mm
- Backing Gel backing
- Roll width 4 meter
- Fire classification Dfl-s1
- Colors 5 standard
- Advantages
 - + suitable for indoor and outdoor use
 - + suitable for residential and contract
 - + waterproof and UV proof
 - + easy cleaning
 - + castor proof



NO DOUBT PRICE LIST

ARTICLE	ARTICLE CODE	COLOR	CUT LENGTH	FULL ROLL (120-136M2)**	RUG WITH OVERLOCK*	RUG WITH FOLDED PADDED EDGE*
Wall-to-wall or rug	NOD9101	9001	€ 159,- / m ²	€ 129,- / m ²	€ 222,- / m ²	€ 339,- / m ²
	NOD9002	9002	€ 159,- / m ²	€ 129,- / m ²	€ 222,- / m ²	€ 339,- / m ²
	NOD9003	9003	€ 159,- / m ²	€ 129,- / m ²	€ 222,- / m ²	€ 339,- / m ²
	NOD9004	9004	€ 159,- / m ²	€ 129,- / m ²	€ 222,- / m ²	€ 339,- / m ²
	NOD9005	9005	€ 159,- / m ²	€ 129,- / m ²	€ 222,- / m ²	€ 339,- / m ²

Your order will be cut from a roll of 4 meters width. Please include the cutting loss in your order. If you need any help calculating this, we are glad to be of service.

* [Click here to see the overview page with our edge finishing options.](#)

Rugs with a folded padded edge will have felted padding at the bottom, therefore they can only be used indoors and can not be used for stair runners. Please calculate a 10 cm margin around all edges for a rug with folded padded edge. Maximum rug width for this finish is 380 cm.

** Only complete rolls can be purchased. Roll lengths vary from 120-136m². Please contact us for the lengths of the rolls.

PLEASE NOTE! Prices shown are public prices including VAT. Please inform for your purchase conditions. The price per m² does not include installation and shipping costs. [Click here to see the overview of shipping costs per country \(page 3\).](#)

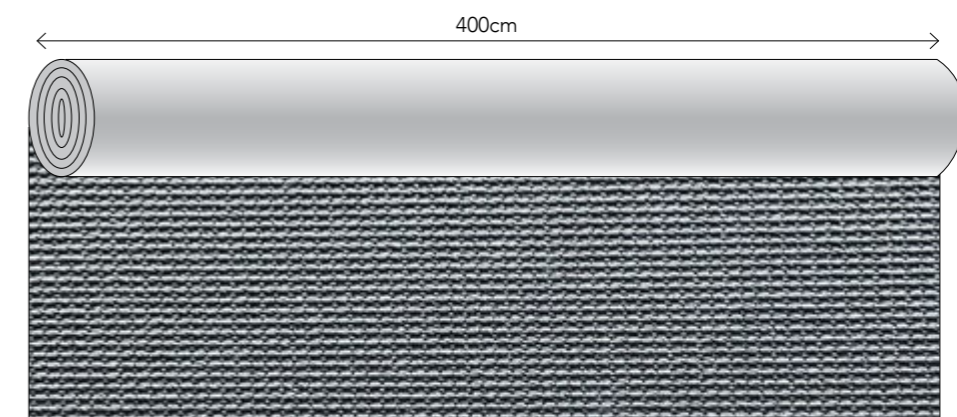

This pattern is not on scale, this image only shows the pattern direction

The cutting and seaming together of a flatweave is a precise and time consuming process with the resulting join likely to be variable in appearance. The durability of seams cannot be guaranteed in multi-width installations, therefore we do not recommend side-to-side or end-to-end joins in a flatweave product. In case seams are desired, it is advisable to use a metal binding strip in case of head seams OR use a carpet seam sealer to seal the edges after cutting.

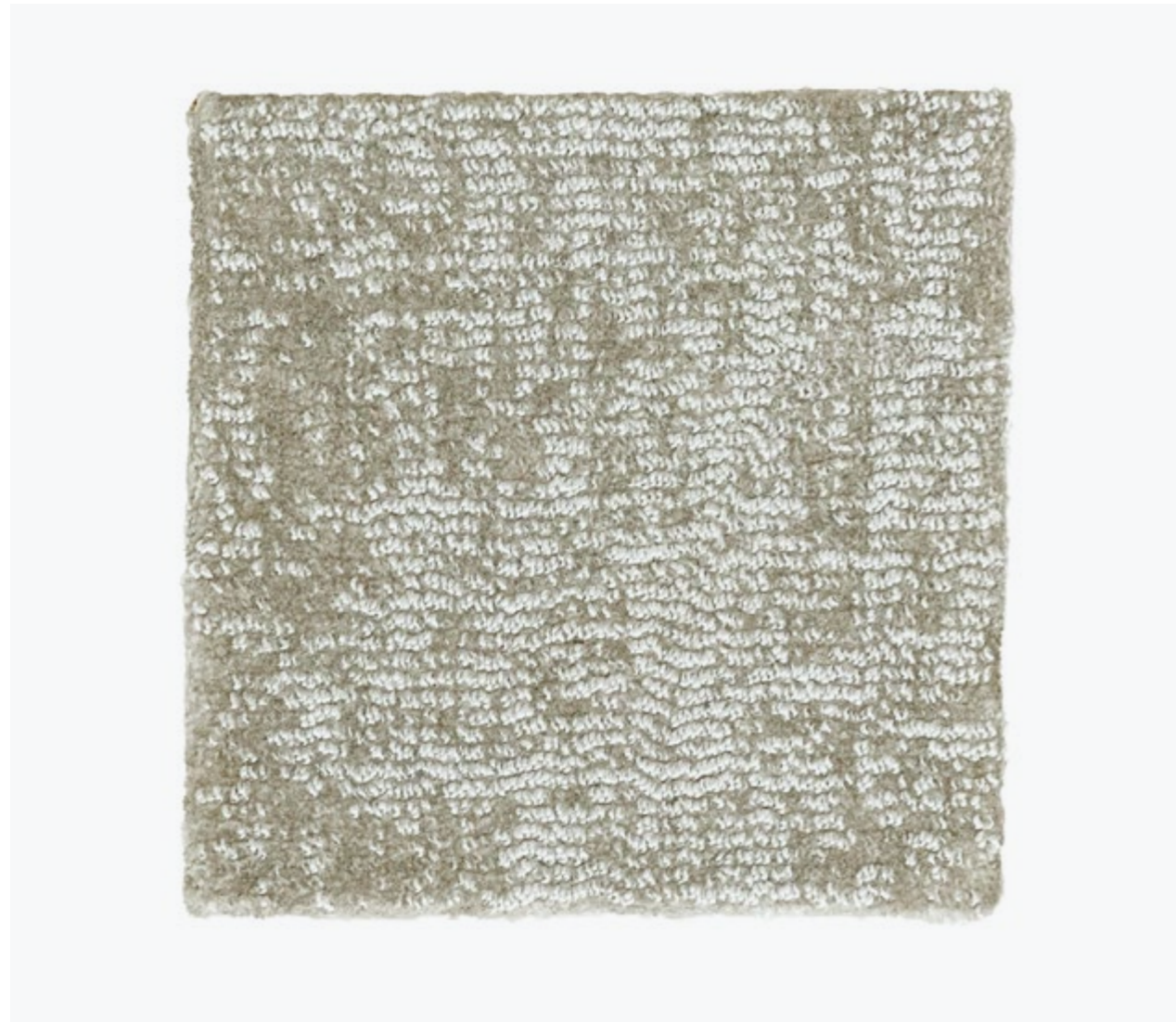

ON RETURN

Available as Rug, wall-to-wall, (stair)runner
 Pile surface Tip-shear
 Pile composition 100% Recycled Plastic
 Shape Rectangular or circular
 Pile weight ± 1.900 g/m²
 Carpet weight ± 2.800 g/m²
 Pile height ± 9,0 mm
 Carpet thickness ± 11,0 mm
 Backing Jute & latex
 Roll width 2 or 4 meter
 Fire classification Cfl-s1
 Colors 12 standard, custom colors available on request from 200 m²
 Advantages
 + suitable for residential as well as contract
 + made from regenerated nylon
 + environmentally friendly & sustainable
 + long-lasting & fire retardant
 + castor proof



ON RETURN PRICE LIST

ARTICLE	ARTICLE CODE	COLOR	CUT LENGTH	FULL ROLL (100-150m ²)**	RUG WITH OVERLOCK EDGE*
Wall-to-wall or rug	ONR6001	6001	€ 270,- / m ²	€ 225,- / m ²	€ 345,- / m ²
	ONR6002	6002	€ 270,- / m ²	€ 225,- / m ²	€ 345,- / m ²
	ONR6003	6003	€ 270,- / m ²	€ 225,- / m ²	€ 345,- / m ²
	ONR6004	6004	€ 270,- / m ²	€ 225,- / m ²	€ 345,- / m ²
	ONR6005	6005	€ 270,- / m ²	€ 225,- / m ²	€ 345,- / m ²
	ONR6006	6006	€ 270,- / m ²	€ 225,- / m ²	€ 345,- / m ²
	ONR6007	6007	€ 270,- / m ²	€ 225,- / m ²	€ 345,- / m ²
	ONR6008	6008	€ 270,- / m ²	€ 225,- / m ²	€ 345,- / m ²
	ONR6009	6009	€ 270,- / m ²	€ 225,- / m ²	€ 345,- / m ²
	ONR6010	6010	€ 270,- / m ²	€ 225,- / m ²	€ 345,- / m ²
	ONR6011	6011	€ 270,- / m ²	€ 225,- / m ²	€ 345,- / m ²
	ONR6012	6012	€ 270,- / m ²	€ 225,- / m ²	€ 345,- / m ²

Your order will be cut from a roll of 2 meters or 4 meters width. Please include the cutting loss in your order. If you need any help calculating this, we are glad to be of service.

Depending on your requested size, a roll of 2 meters or 4 meters width will be selected for cutting. The roll width of 2 meters is available up to 7,5 linear meters maximum. All orders that require an amount of linear meters above 7,5 meter will be cut from a roll of 4 meters width.

* [Click here to see the overview page with our edge finishing options.](#)

** Only complete rolls can be purchased. Roll lengths vary from 100-150m². Please contact us for the lengths of the rolls.

PLEASE NOTE! Prices shown are public prices including VAT. Please inform for your purchase conditions. The price per m² does not include installation and shipping costs. [Click here to see the overview of shipping costs per country \(page 3\).](#)

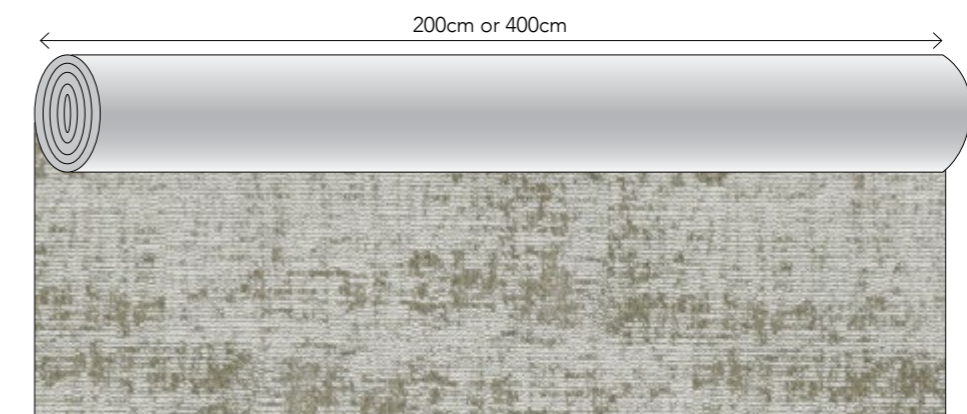

This pattern is not on scale, this image only shows the pattern direction



OUT LINE

Available as	Rug, runner
Pile surface	Loop pile
Pile composition	100% Wool
Size	4m width, up to 32m length
Shape	Any shape possible
Carpet weight	± 2.700 g/m ²
Carpet thickness	± 7 mm
Backing	Jute & cotton
Roll width	4 meters
Fire classification	Bfl-s1
Colors	4 standard colors
Advantages	+ suitable for heavy domestic use and soft contract + durable and hypoallergenic properties + natural backing with jute and cotton + custom shape possible



OUT LINE PRICE LIST

ARTICLE	ARTICLE CODE	COLOR	PRICE P/M ² WITH OVERLOCK EDGE*
Rug	OUL1801	1801	€ 335,-
	OUL1802	1802	€ 335,-
	OUL1803	1803	€ 335,-
	OUL1804	1804	€ 335,-

Your rug will be cut from a roll of 4 meters width. Please take cutting loss into account, in case the requested rug size is smaller than the width of the roll. If you need any help with calculations, we are glad to be of service.

* [Click here to see the overview page with our edge finishing options.](#)

PLEASE NOTE! Prices shown are public prices including VAT and do not include the shipping costs. [Click here to see the overview of shipping costs per country \(page 3\).](#) This product is always rolled in the roll width direction to maintain its structural integrity. Please note that this can affect the transportation costs, depending on the size of the rug.



This pattern is not on scale, this image only shows the pattern direction



ROLL OVER

Available as Rug, wall-to-wall, (stair)runner
 Pile surface Loop Pile
 Pile composition 100% Wool
 Size Maximum 4m width, up to 32m length
 Shape Rectangular or circular
 Pile weight ± 1.060 g/m²
 Carpet weight ± 2.000 g/m²
 Pile height ± 3,0 mm
 Carpet thickness ± 4,0 mm
 Backing P.P. & Latex
 Roll width 2 or 4 meter
 Fire classification Bfl-s1
 Colors 6 standard
 Advantages + suitable for residential as well as contract
 + long-lasting & fire retardant
 + available as stair runner
 + castor proof
 + VOC-emission label A+

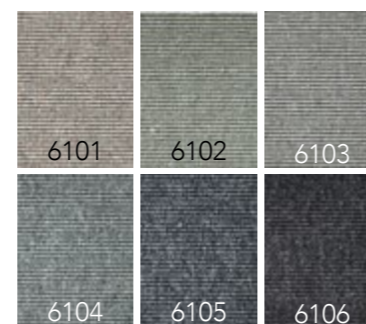

ROLL OVER PRICE LIST

ARTICLE	ARTICLE CODE	COLOR	CUT LENGTH	FULL ROLL (100-150m ²)**	RUG WITH FOLDED EDGE*
Wall-to-wall or rug	ROO6101	6101	€ 120,- / m ²	€ 99,- / m ²	€ 215,- / m ²
	ROO6102	6102	€ 120,- / m ²	€ 99,- / m ²	€ 215,- / m ²
	ROO6103	6103	€ 120,- / m ²	€ 99,- / m ²	€ 215,- / m ²
	ROO6104	6104	€ 120,- / m ²	€ 99,- / m ²	€ 215,- / m ²
	ROO6105	6105	€ 120,- / m ²	€ 99,- / m ²	€ 215,- / m ²
	ROO6106	6106	€ 120,- / m ²	€ 99,- / m ²	€ 215,- / m ²

Your order will be cut from a roll of 2 meters or 4 meters width. Please include the cutting loss in your order. If you need any help calculating this, we are glad to be of service.

Depending on your requested size, a roll of 2 meters or 4 meters width will be selected for cutting. The roll width of 2 meters is available up to 7,5 linear meters maximum. All orders that require an amount of linear meters above 7,5 meter will be cut from a roll of 4 meters width.

* Click here to see the overview page with our edge finishing options.

** Only complete rolls can be purchased. Roll lengths vary from 100-150m². Please contact us for the lengths of the rolls.

PLEASE NOTE! Prices shown are public prices including VAT. Please inform for your purchase conditions. The price per m² does not include installation and shipping costs. Click here to see the overview of shipping costs per country (page 3).

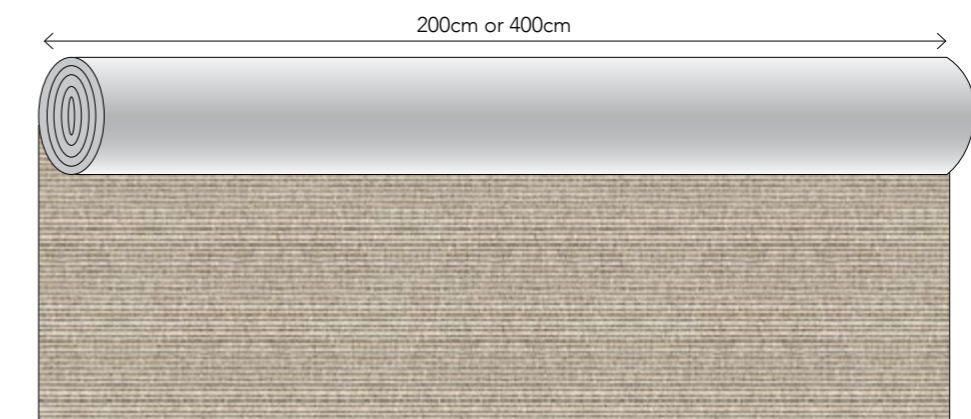

This pattern is not on scale, this image only shows the pattern direction



STEP UP 16

Available as Rug, wall-to-wall
 Pile surface Cut Pile
 Pile composition 100% Pure New Wool
 Shape Rectangular or circular
 Pile weight ± 2.525 g/m²
 Carpet weight ± 4.025 g/m²
 Pile height ± 14,0 mm
 Carpet thickness ± 16,0 mm
 Backing Action Back P.P.
 Roll width 2 or 4 meter
 Fire classification Cfl-s1
 Colors 9 standard colors, custom colors available on request from 100 m²
 Advantages + suitable for residential as well as contract
 + long-lasting & fire retardant
 + VOC-emission label A+



STEP UP 16 PRICE LIST

ARTICLE	ARTICLE CODE	COLOR	CUT LENGTH	FULL ROLL (100-150m ²)**	RUG WITH SHAVEN EDGE*
Wall-to-wall or rug	STU6201	6201	€ 375,- / m ²	€ 299,- / m ²	€ 465,- / m ²
	STU6202	6202	€ 375,- / m ²	€ 299,- / m ²	€ 465,- / m ²
	STU6203	6203	€ 285,- / m ²	€ 239,- / m ²	€ 405,- / m ²
	STU6204	6204	€ 285,- / m ²	€ 239,- / m ²	€ 405,- / m ²
	STU6205	6205	€ 285,- / m ²	€ 239,- / m ²	€ 405,- / m ²
	STU6206	6206	€ 285,- / m ²	€ 239,- / m ²	€ 405,- / m ²
	STU6207	6207	€ 285,- / m ²	€ 239,- / m ²	€ 405,- / m ²
	STU6208	6208	€ 285,- / m ²	€ 239,- / m ²	€ 405,- / m ²
	STU6209	6209	€ 285,- / m ²	€ 239,- / m ²	€ 405,- / m ²

Your order will be cut from a roll of 2 meters or 4 meters width. Please include the cutting loss in your order. If you need any help calculating this, we are glad to be of service.

Depending on your requested size, a roll of 2 meters or 4 meters width will be selected for cutting. The roll width of 2 meters is available up to 7,5 linear meters maximum. All orders that require an amount of linear meters above 7,5 meter will be cut from a roll of 4 meters width.

* Click here to see the overview page with our edge finishing options.

** Only complete rolls can be purchased. Roll lengths vary from 100-150m². Please contact us for the lengths of the rolls.

PLEASE NOTE! Prices shown are public prices including VAT. Please inform for your purchase conditions. The price per m² does not include installation and shipping costs. Click here to see the overview of shipping costs per country (page 3).



STEP UP 9

Available as Rug, wall-to-wall
 Pile surface Cut Pile
 Pile composition 100% Pure New Wool
 Shape Rectangular or circular
 Pile weight ± 1.350 g/m²
 Carpet weight ± 2.850 g/m²
 Pile height ± 7,2mm
 Carpet thickness ± 9,2 mm
 Backing Action Back P.P.
 Roll width 2 or 4 meter
 Fire classification Bfl-s1
 Colors 20 standard colors, custom colors available on request from 200 m²
 Advantages + available as stair runner
 + suitable for residential as well as contract
 + long-lasting & fire retardant
 + VOC-emission label A+

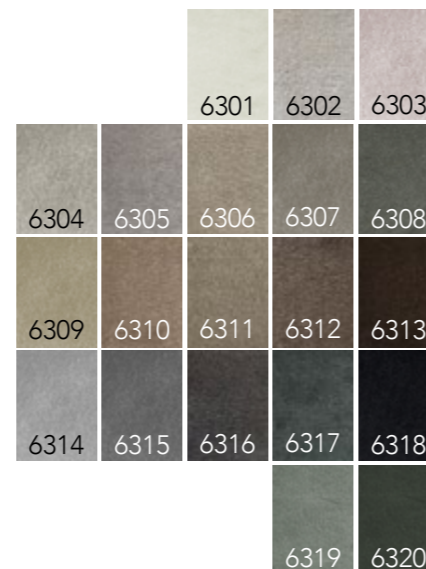

STEP UP 9 PRICE LIST

ARTICLE	ARTICLE CODE	COLOR	CUT LENGTH	FULL ROLL (100-150m ²)**	RUG WITH OVERLOCK EDGE*
Wall-to-wall or rug	STU6301	6301	€ 199,- / m ²	€ 159,- / m ²	€ 265,- / m ²
	STU6302	6302	€ 199,- / m ²	€ 159,- / m ²	€ 265,- / m ²
	STU6303	6303	€ 199,- / m ²	€ 159,- / m ²	€ 265,- / m ²
	STU6304	6304	€ 169,- / m ²	€ 136,- / m ²	€ 235,- / m ²
	STU6305	6305	€ 169,- / m ²	€ 136,- / m ²	€ 235,- / m ²
	STU6306	6306	€ 169,- / m ²	€ 136,- / m ²	€ 235,- / m ²
	STU6307	6307	€ 169,- / m ²	€ 136,- / m ²	€ 235,- / m ²
	STU6308	6308	€ 169,- / m ²	€ 136,- / m ²	€ 235,- / m ²
	STU6309	6309	€ 169,- / m ²	€ 136,- / m ²	€ 235,- / m ²
	STU6310	6310	€ 169,- / m ²	€ 136,- / m ²	€ 235,- / m ²
	STU6311	6311	€ 169,- / m ²	€ 136,- / m ²	€ 235,- / m ²
	STU6312	6312	€ 169,- / m ²	€ 136,- / m ²	€ 235,- / m ²
	STU6313	6313	€ 169,- / m ²	€ 136,- / m ²	€ 235,- / m ²
	STU6314	6314	€ 169,- / m ²	€ 136,- / m ²	€ 235,- / m ²
	STU6315	6315	€ 169,- / m ²	€ 136,- / m ²	€ 235,- / m ²
	STU6316	6316	€ 169,- / m ²	€ 136,- / m ²	€ 235,- / m ²
	STU6317	6317	€ 169,- / m ²	€ 136,- / m ²	€ 235,- / m ²
	STU6318	6318	€ 169,- / m ²	€ 136,- / m ²	€ 235,- / m ²
	STU6319	6319	€ 169,- / m ²	€ 136,- / m ²	€ 235,- / m ²
	STU6320	6320	€ 169,- / m ²	€ 136,- / m ²	€ 235,- / m ²

Your order will be cut from a roll of 2 meters or 4 meters width. Please include the cutting loss in your order. If you need any help calculating this, we are glad to be of service.

Depending on your requested size, a roll of 2 meters or 4 meters width will be selected for cutting. The roll width of 2 meters is available up to 7,5 linear meters maximum. All orders that require an amount of linear meters above 7,5 meter will be cut from a roll of 4 meters width.

* [Click here to see the overview page with our edge finishing options.](#)

** Only complete rolls can be purchased. Roll lengths vary from 100-150m². Please contact us for the lengths of the rolls.

PLEASE NOTE! Prices shown are public prices including VAT. Please inform for your purchase conditions. The price per m² does not include installation and shipping costs. [Click here to see the overview of shipping costs per country \(page 3\).](#)

RUG EDGE FINISHING OPTIONS



Overlock edge finish (1 cm)

This edge finish is available for:

- All Star
- Day Off
- Easy Going
- Front Row
- Good Life
- High Tide
- No Doubt
- Next Step
- On Return (with straight or rounded corner)
- Step up 9 (with straight or rounded corner)



Hand shaven edge finish

This edge finish is available for:

- Step Up 16.



Border finish (3cm)

This edge finish is available for:

- Day Off
- Easy Going
- Good Life
- High Tide

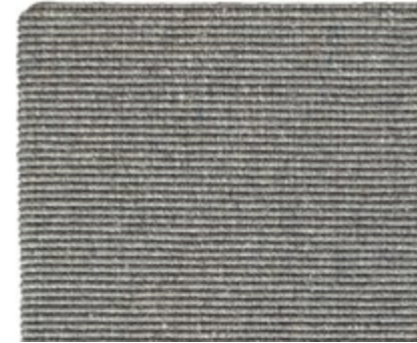

Folded edge finish

This edge finish is available for:

- Roll Over

For rugs with a folded edge please calculate a 10cm margin around all edges. Maximum rug width for this finish is 380 cm.

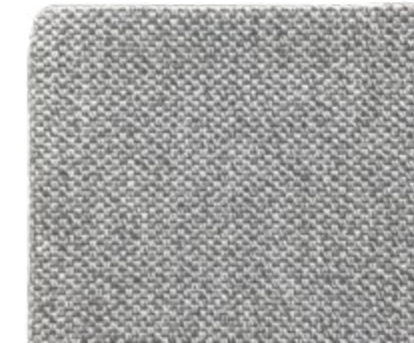

Folded padded edge finish

This edge finish is available for:

- All Star
- Front Row
- Next Step
- No Doubt

Please calculate a 10cm margin around all edges for a rug with folded padded edge. Maximum rug width for this finish is 380 cm.

Rugs with a folded padded edge will have felted padding at the bottom, therefore they can only be used indoors and can not be used for stair runners.



Wool overlock edge finish

This edge finish is available for:

- Lay Out
- Line Up
- Out Line

SAMPLE PRICE LIST

ARTICLE	SAMPLE TYPE	SIZE	PRICE P/PIECE
	Contract box (all contract options)	115 samples in 5 boxes	€ 575,-
	Contract A (indoor)	56 samples in 2 boxes	€ 275,-
	Contract B (indoor/outdoor)	47 samples in 2 boxes	€ 175,-
	Contract C (wool)	12 samples in 1 box	€ 125,-

CARE INSTRUCTIONS INDOOR RUGS

All our products are made with care and attention. In order to keep them as beautiful as they are, please mind the following care instructions:

- We advise you to vacuum the carpet once or twice a week for domestic applications and light use areas. For commercial applications and heavier traffic use, daily vacuuming is advised to reduce the presence and buildup of loose dirt particles.
- For flat weave carpets use a suction only vacuum to prevent distortion or pilling of the carpet surface. Do not use the brush or beater bar.
- While vacuuming, the starting point should be varied each time to make sure that the carpet is not always brushed in the same direction.
- Wet stains need to be removed immediately, before the yarn absorbs the fluid. Absorb the stain using a strong absorbing paper (like kitchen paper) or clean towel.
- High traffic area stains from castor wheels, luggage and service trollies may result in rubber transfer markings. Rubber markings may become sticky or attract dirt from foot and wheeled traffic builds up on the original stain. Remove rubber from the fibres using an approved gel type solvent. The treated area must be thoroughly rinsed out otherwise any remaining residue will continue to attract dirt.
- Light stains can safely be treated with JAMES cleaning agents, which have been successfully tested on our products. Please follow the instructions of the JAMES staindisc delivered with the James starter kit. Treating stains within 24 hours increases the possibility of successful stain removal, nevertheless, complete removal can never be guaranteed. The usage of a cleaning agent that is not tested on our products cannot be guaranteed for safe cleaning.
- In case of heavy staining or transferred dirt, we advise you to always have your rug cleaned by a specialist in rug cleaning.
- When in doubt, please don't hesitate to contact us or take a look on our website, www.frankly.amsterdam/careinstructions, for more information.

CARE INSTRUCTIONS OUTDOOR RUGS

- We recommend regular (monthly) cleaning of the outdoor rug.
- Vacuum the rug with a normal (upright or cylinder) vacuum cleaner without the brush or beater bar engaged. Avoid vacuuming over 1200W.
- After vacuuming, you can use cold water with a pH neutral soap or a non-ionic detergent to remove all dirt on both sides of the rug. Dry the rug in the sun afterwards.
- Stains need to be removed as soon as possible. Absorb the stain using a strong absorbing paper (like kitchen paper) or a clean cloth.
- Remove stains using pH neutral soap or dish soap and scrub it gently with warm water.
- Do not use highly acidic cleaning agents to remove stains from your rug. This can cause discoloration of the yarn.
- In case of heavy staining we advise you to always have your rug cleaned by a specialist in rug cleaning.
- To avoid the rug getting moldy hang or lay down the rug in sunlight on a clean surface. For the rug to be completely dry, alternate the sides.
- If you would like to storage your outdoor rug you need to clean it properly first. Make sure you never fold your rug. You have to roll it up, wrap it in plastic and secure it with tape for example.
- When in doubt, please don't hesitate to contact us, or take a look on our website, www.frankly.amsterdam/careinstructions, for more information.

WARRANTY

- Frankly Amsterdam guarantees its rugs for 2 years of normal use.
- All our products are made with care. In case a manufacturing defect escaped our attention, please inform us within 14 days after delivery and leave the product unused.
- Small differences or irregularities in color, weft or size may occur. This is inherent to the use of natural fibers and has to be accepted when within normal commercial tolerances.

