



FRANKLY  
AMSTERDAM

PRICE LIST RUG COLLECTION  
July 2024

**TERMS AND CONDITIONS**

Our general terms and conditions of sales apply to all our agreements, quotations and offers. Please find a copy at [www.frankly.amsterdam/salesconditions](http://www.frankly.amsterdam/salesconditions) or at the Chambers of Commerce Amsterdam number 34393141. The terms and conditions used by the other party shall be explicitly excluded.

Every product made from a natural material is unique. Therefore a small difference in size or color may occur. We strongly advise not to expose fabrics of our indoor products to direct sunlight.

Frankly Amsterdam is owner of the goods until they have been completely paid.

**PRICES**

Prices to public are issued in euros, including VAT.

**SHIPPING**

Goods travel at buyer's risk and danger: possible damages must be reported at delivery immediately. For transportation of our rugs we collaborate closely with shipping agencies specialised in high-end transportation. The rugs are shipped in rolls that have to be transported laying down, and can not be stacked underneath other cargo under any circumstance.

Because of this precise method of transportation, damages in transport rarely occurs. Despite this, we advise you to check the roll upon receipt for any damages. Please make sure to confirm that the packaging and the roll are both still in tact.

Any unexpected damages discovered upon arrival must be noted on the loading bill. Alongside this, Frankly Amsterdam wishes to receive notice of the damages, including pictures of the damaged packaging. After the client signs for completed delivery, there is no possibility to claim transport damages.

**SHIPPING COSTS FOR RUGS**

- Shipping costs vary per order depending on the number or rolls, size of the rolls, the country and the shipping method. Please see the overview on the next page.
- All orders under €350,- (purchase price excluding VAT) are subject to a surcharge. The freight/administration surcharge is €29,-

**DELIVERY**

The delivery time of our tufted rugs is 6 weeks including transportation. The delivery time of our woven rugs and wall rugs is 8 weeks including transportation. The delivery date stated on the order confirmation is approximate and free of obligation. This shall not be considered to be a strict deadline unless a certain delivery date is explicitly guaranteed by Frankly Amsterdam.

For tufted rugs we can offer a quick delivery service. If the requested yarn is on stock, the rug can be shipped within 48 hours or 2 weeks. Feel free to contact us for the conditions and prices.

**SHIPPING COSTS FOR RUGS (EXCL. VAT)**

	NUMBER OF ROLLS PER ORDER	SMALL ROLL <160CM	MEDIUM ROLL 160-280CM	LARGE ROLL >280CM
<b>AUSTRIA</b>	1	€ 292,-	€ 316,-	€ 341,-
	2	€ 200,-	€ 219,-	€ 237,-
	3	€ 170,-	€ 186,-	€ 202,-
	4	€ 155,-	€ 170,-	€ 185,-
	5	€ 146,-	€ 160,-	€ 175,-
<b>BELGIUM</b>	1	€ 161,-	€ 174,-	€ 186,-
	2	€ 137,-	€ 150,-	€ 163,-
	3	€ 129,-	€ 142,-	€ 155,-
	4	€ 126,-	€ 138,-	€ 151,-
	5	€ 123,-	€ 136,-	€ 149,-
<b>GERMANY</b>	1	€ 247,-	€ 273,-	€ 298,-
	2	€ 181,-	€ 200,-	€ 219,-
	3	€ 158,-	€ 175,-	€ 192,-
	4	€ 147,-	€ 163,-	€ 179,-
	5	€ 140,-	€ 156,-	€ 171,-
<b>THE NETHERLANDS</b>	1	€ 155,-	€ 167,-	€ 180,-
	2	€ 134,-	€ 147,-	€ 160,-
	3	€ 127,-	€ 140,-	€ 153,-
	4	€ 124,-	€ 137,-	€ 149,-
	5	€ 122,-	€ 135,-	€ 147,-
<b>SWITZERLAND</b>	1	€ 305,-	€ 330,-	€ 355,-
	2	€ 209,-	€ 228,-	€ 247,-
	3	€ 177,-	€ 194,-	€ 211,-
	4	€ 161,-	€ 177,-	€ 193,-
	5	€ 152,-	€ 167,-	€ 182,-
For Switzerland the Customs Clearance costs per order are € 55,- (excl. VAT).				
<b>OTHER COUNTRIES</b>	Shipping costs on request			

## INDEX

This is an interactive price list.

By clicking on the product name, you will be directed to the product page.

By clicking on our logo you will return to this index.

### FRANKLY COLLECTION

#### TUFTED RUGS

At Ease  
At Random  
Chasing Light  
Colour Me  
Cotton Candy 12  
Cotton Candy 22  
Corner Stone  
Day Light  
Day Light Pattern A, B, C, D  
Done Deal  
Land Mark  
Moon Parts  
Move Slow  
New Start  
New Start Pattern A  
Night Fire  
On Return  
Perfect Match  
Saint Cloud  
Second Nature  
Show Off  
Show Off gradient  
Step Up 16  
Step Up 9  
Super Moon  
Super Moon 45  
Think Big  
Un Fold  
Gradient rugs

#### WOVEN RUGS

All Star  
Bottom Line  
Eagle Eye  
Easy Going  
Front Row  
Good Life  
High Tide  
Lay Out  
Line Up  
Mile Stone  
Next Step  
No Doubt  
Out Line  
Roll Over

#### OUTDOOR RUGS

All Star  
Bottom Line outdoor  
Easy Going  
Front Row  
Good Life  
High Tide  
Next Step  
No Doubt  
Off Shore  
Over Seas

#### SAMPLES

### FRANKLY STUDIO

#### TUFTED RUGS

After Glow  
Capital City  
En Suite  
Full Circle  
Night Fire Pattern  
The Moon

#### WALL RUGS

Vertical Transformation  
Hanging system

#### COLOR OPTIONS

Eucalyptus  
Wool  
Mohair  
Bamboo  
Biodegradable PET  
Cotton

#### CARE INSTRUCTIONS

#### WARRANTY

FRANKLY  
AMSTERDAM

TUFTED RUGS





AT EASE PRICE LIST

ARTICLE	ARTICLE CODE	COLOR	PRICE P/M <sup>2</sup>
Rug	ATE3301	3301	€ 650,-
	ATE3302	3302	€ 650,-
	ATE3303	3303	€ 650,-
	ATE3304	3304	€ 650,-
	ATE3305	3305	€ 650,-
	ATE3306	3306	€ 650,-
	ATE3307	3307	€ 650,-
	ATE3308	3308	€ 650,-
	ATE3309	3309	€ 650,-
	ATE3310	3310	€ 650,-

PLEASE NOTE! Prices shown are public prices including VAT. The price per m<sup>2</sup> does not include the shipping costs. Click here to see the overview of shipping costs per country (page 3)..

AT EASE

Available as Rug, wall-to-wall, runner  
 Design Frankly Amsterdam  
 Size Any size and shape possible  
 Weight 6000 gr/m<sup>2</sup>  
 Height 35 mm (standard) or custom height  
 Technique Hand tufted  
 Colors 10 Standard + 220 uni + any custom color  
 Color design Christiane Müller  
 Material 50% Eucalyptus, 50% Wool  
 Fire classification Eucalyptus Cfl-s1, Wool Bfl-s1  
 Advantages + any size and shape possible  
 + possibility to create your own mix color out of 220 uni colors (see Eucalyptus box & Wool box)  
 + custom colors can be lab-dyed on request (ask about the terms and possibilities)  
 + suitable for residential as well as soft contract



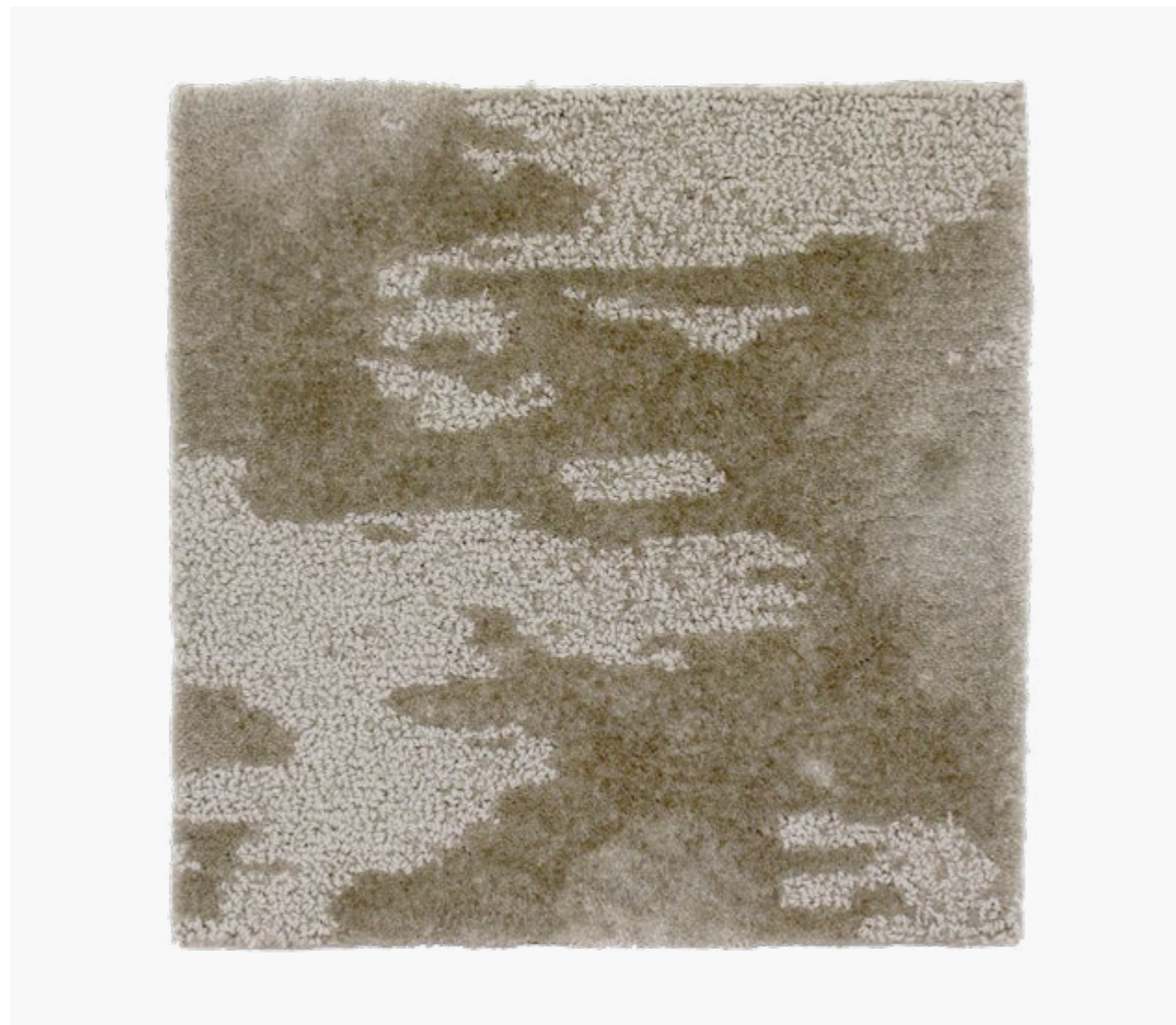

AT RANDOM PRICE LIST

ARTICLE	ARTICLE CODE	COLOR	PRICE P/M <sup>2</sup>
Rug	ATR2301	2301	€ 639,-
	ATR2302	2302	€ 639,-
	ATR2303	2303	€ 639,-
	ATR2304	2304	€ 639,-
	ATR2305	2305	€ 639,-
	ATR2306	2306	€ 639,-
	ATR2307	2307	€ 639,-
	ATR2308	2308	€ 639,-

PLEASE NOTE! Prices shown are public prices including VAT. The price per m<sup>2</sup> does not include the shipping costs. Click here to see the overview of shipping costs per country (page 3).

AT RANDOM

Available as Rug, wall-to-wall, (stair)runner  
 Design Christiane Müller & Frankly Amsterdam  
 Size Any size and shape possible  
 Weight 4500 gr/m<sup>2</sup>  
 Height 8 mm  
 Technique Hand tufted  
 Colors 8 Standard + 51 uni + any custom color  
 Color design Christiane Müller  
 Material 100% Thick Eucalyptus  
 Fire classification Cfl-s1  
 Advantages  
 + any size, pattern and shape possible  
 + choose your own color (mix or uni) out of 51 uni colors (see Eucalyptus color box)  
 + custom colors can be lab-dyed on request (ask about the terms and possibilities)  
 + suitable for residential as well as soft contract

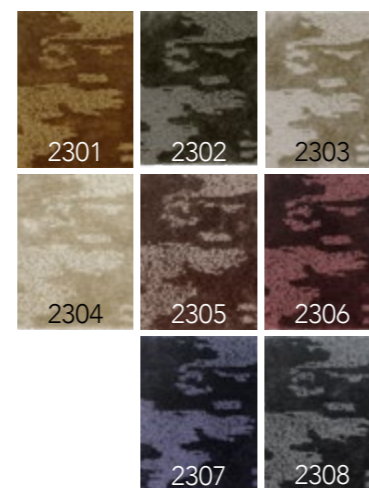



CHASING LIGHT PRICE LIST

ARTICLE	ARTICLE CODE	COLOR	PRICE P/M <sup>2</sup>
Rug	CHL2901	2901	€ 745,-
	CHL2902	2902	€ 745,-
	CHL2903	2903	€ 745,-
	CHL2904	2904	€ 745,-
	CHL2905	2905	€ 745,-
	CHL2906	2906	€ 745,-

PLEASE NOTE! Prices shown are public prices including VAT. The price per m<sup>2</sup> does not include the shipping costs. Click here to see the overview of shipping costs per country (page 3).

CHASING LIGHT

Available as Rug, wall-to-wall, (stair)runner  
 Design Remy Meijers  
 Size Any size and shape possible  
 Weight 4700 gr/m<sup>2</sup>  
 Height 8 + 10 mm  
 Technique Hand tufted  
 Colors 6 Standard + 110 uni + any custom color  
 Color design Remy Meijers  
 Material 100% Eucalyptus  
 Fire classification Cfl-s1  
 Advantages + any size, pattern and shape possible  
 + choose your own color (mix or uni) out of 110 uni colors (see Eucalyptus color box)  
 + custom colors can be lab-dyed on request (ask about the terms and possibilities)  
 + suitable for residential as well as soft contract





COLOUR ME

Available as Rug, wall-to-wall, (stair)runner  
 Design Frankly Amsterdam  
 Size Any size and shape possible  
 Weight 5000 gr/m<sup>2</sup>  
 Height 16 mm (standard) or custom height  
 Technique Hand tufted  
 Colors 9 Standard + 51 uni + any custom color  
 Color design Christiane Müller  
 Material 100% Thick Eucalyptus  
 Fire classification Cfl-s1  
 Advantages + any size, pattern and shape possible  
 + choose your own color (mix or uni) out of 51 uni colors (see Eucalyptus color box)  
 + custom colors can be lab-dyed on request (ask about the terms and possibilities)  
 + suitable for residential as well as soft contract

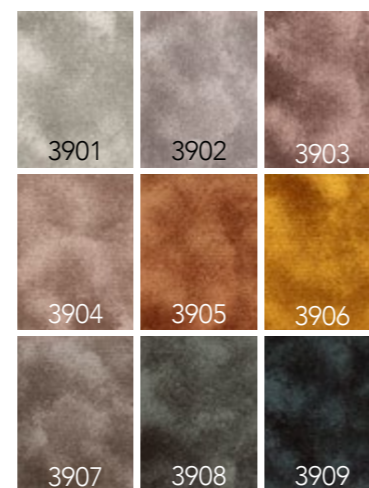

COLOUR ME PRICE LIST

ARTICLE	ARTICLE CODE	COLOR	PRICE P/M <sup>2</sup>
Rug	COM3901	3901	€ 620,-
	COM3902	3902	€ 620,-
	COM3903	3903	€ 620,-
	COM3904	3904	€ 620,-
	COM3905	3905	€ 620,-
	COM3906	3906	€ 620,-
	COM3907	3907	€ 620,-
	COM3908	3908	€ 620,-
	COM3909	3909	€ 620,-

PLEASE NOTE! Prices shown are public prices including VAT. The price per m<sup>2</sup> does not include the shipping costs. Click here to see the overview of shipping costs per country (page 3).





COTTON CANDY 12

Available as Rug, wall-to-wall, (stair)runner  
 Design Frankly Amsterdam  
 Size Any size and shape possible  
 Weight 4.500 gr/m2  
 Height 12 mm (standard) or custom height up to 30 mm  
 Technique Hand tufted  
 Colors 55 standard + any custom color  
 Color design Frankly Amsterdam  
 Material 100% Cotton  
 Advantages + any size, pattern and shape possible  
 + choose your own color (uni or mix up to 10 colors) out of 55 colors from our Cotton color box  
 + custom colors can be lab-dyed on request  
 + suitable for residential use



color box with 55 color options

COTTON CANDY 12 PRICE LIST

ARTICLE	ARTICLE CODE	COLOR	PRICE P/M <sup>2</sup>
Rug	COC12 1	1	€ 595,-
	COC12 2	2	€ 595,-
	COC12 3	3	€ 595,-
	COC12 4	4	€ 595,-
	COC12 5	5	€ 595,-
	up to COC12 55	55	€ 595,-

ARTICLE	ARTICLE CODE	PILE HEIGHT	PRICE P/M <sup>2</sup>
Rug	COC-special (runner)	12mm	€ 595,-
	COC-special	13-25 mm	€ 615,-
	COC-special	26-30 mm	€ 640,-

PLEASE NOTE! Prices shown are public prices including VAT. The price per m<sup>2</sup> does not include the shipping costs. Click here to see the overview of shipping costs per country (page 3).



COTTON CANDY 22

Available as	Rug, wall-to-wall, runner
Design	Frankly Amsterdam
Size	Any size and shape possible
Weight	4.200 gr/m <sup>2</sup>
Height	22 mm (standard) or custom height up to 30 mm
Technique	Hand tufted
Colors	55 standard + any custom color
Color design	Frankly Amsterdam
Material	100% Cotton
Advantages	+ any size, pattern and shape possible + choose your own color (uni or mix up to 10 colors) out of 55 colors from our Cotton color box + custom colors can be lab-dyed on request + suitable for residential use



color box with 55 color options

COTTON CANDY 22 PRICE LIST

ARTICLE	ARTICLE CODE	COLOR	PRICE P/M <sup>2</sup>
Rug	COC22 1	1	€ 615,-
	COC22 2	2	€ 615,-
	COC22 3	3	€ 615,-
	COC22 4	4	€ 615,-
	COC22 5	5	€ 615,-
	up to COC22 55	55	€ 615,-

ARTICLE	ARTICLE CODE	PILE HEIGHT	PRICE P/M <sup>2</sup>
Rug	COC-special (runner)	12mm	€ 595,-
	COC-special	13-25 mm	€ 615,-
	COC-special	26-30 mm	€ 640,-

PLEASE NOTE! Prices shown are public prices including VAT. The price per m<sup>2</sup> does not include the shipping costs. Click here to see the overview of shipping costs per country (page 3).



**CORNER STONE**

Available as Rug, wall-to-wall, runner  
 Design Diederik Dam  
 Size Any size possible  
 Weight 6500 gr/m<sup>2</sup>  
 Height 12 - 25 mm  
 Technique Hand tufted and hand carved  
 Colors 8 Standard + 110 uni + any custom color  
 Color design Christiane Müller  
 Material 100% Mohair  
 Fire classification Bfl-s1  
 Advantages  
 + suitable for residential as well as soft contract  
 + any size and shape possible  
 + exclusive design  
 + special graphic 3D look  
 + choose your own color (mix or uni) out of 110 uni colors (see Mohair color box)



**CORNER STONE PRICE LIST**

ARTICLE	ARTICLE CODE	COLOR	PRICE P/M <sup>2</sup>
Rug	COS4501	4501	€ 975,-
	COS4502	4502	€ 975,-
	COS4503	4503	€ 975,-
	COS4504	4504	€ 975,-
	COS4505	4505	€ 975,-
	COS4506	4506	€ 975,-
	COS4507	4507	€ 975,-
	COS4508	4508	€ 975,-

PLEASE NOTE! Prices shown are public prices including VAT. The price per m<sup>2</sup> does not include the shipping costs. Click here to see the overview of shipping costs per country (page 3).

Standard edge:

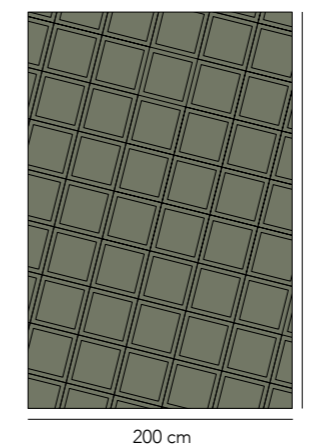

Special edition edge:\*

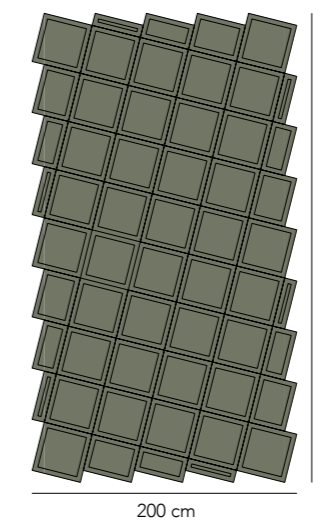

\* Special Edition is only available in certain sizes. Ask for the terms and prices!



DAY LIGHT

Available as Rug, wall to wall  
 Design Frankly Amsterdam  
 Size Any size and shape possible  
 Weight 5500 gr/m2  
 Height 14 mm  
 Technique Handtufted  
 Colors 10 Standard + 77 uni + any custom color  
 Color design Christiane Müller  
 Material 100% Bamboo  
 Fire classification Cfl-s1  
 Advantages  
 + European production  
 + any size, pattern and shape possible  
 + choose your own color (mix or uni) out of 77 uni colors (see Bamboo color box)  
 + custom colors can be lab-dyed on request  
 + anti-bacterial and suitable for people with allergies



DAY LIGHT PRICE LIST

ARTICLE	ARTICLE CODE	COLOR	PRICE P/M <sup>2</sup>
Rug	DAL6701	6701	€ 630,-
	DAL6702	6702	€ 630,-
	DAL6703	6703	€ 630,-
	DAL6704	6704	€ 630,-
	DAL6705	6705	€ 630,-
	DAL6706	6706	€ 630,-
	DAL6707	6707	€ 630,-
	DAL6708	6708	€ 630,-
	DAL6709	6709	€ 630,-
	DAL6710	6710	€ 630,-

ARTICLE	ARTICLE CODE	PILE HEIGHT	PRICE P/M <sup>2</sup>
Rug	DAL-special	14-18 mm	€ 630,-
	DAL-special	20-29 mm	€ 669,-
	DAL-special	30-39 mm	€ 709,-
	DAL-special	40-45 mm	€ 749,-

PLEASE NOTE! Prices shown are public prices including VAT. The price per m<sup>2</sup> does not include the shipping costs. Click here to see the overview of shipping costs per country (page 3).



DAY LIGHT PATTERN A

Available as Rug, wall to wall  
 Design Frankly Amsterdam  
 Size Any size and shape possible  
 Weight 5800 gr/m2  
 Height 14 / 17 mm (Pattern A)  
 Technique Handtufted  
 Colors 10 Standard + 77 uni  
 Color design Christiane Müller  
 Material 100% Bamboo  
 Fire classification Cfl-s1  
 Advantages  
 + European production  
 + any size, color and shape possible  
 + custom patterns possible on request  
 + custom colors can be lab-dyed on request  
 + anti-bacterial and suitable for people with allergies



DAY LIGHT PATTERN A PRICE LIST

ARTICLE	ARTICLE CODE	COLOR	PRICE P/M <sup>2</sup>
Rug with pattern A	DAL6701-A	6701	€ 669,-
	DAL6702-A	6702	€ 669,-
	DAL6703-A	6703	€ 669,-
	DAL6704-A	6704	€ 669,-
	DAL6705-A	6705	€ 669,-
	DAL6706-A	6706	€ 669,-
	DAL6707-A	6707	€ 669,-
	DAL6708-A	6708	€ 669,-
	DAL6709-A	6709	€ 669,-
	DAL6710-A	6710	€ 669,-

PLEASE NOTE! Prices shown are public prices including VAT. The price per m<sup>2</sup> does not include the shipping costs. Click here to see the overview of shipping costs per country (page 3).

Pattern example 200 x 300 cm

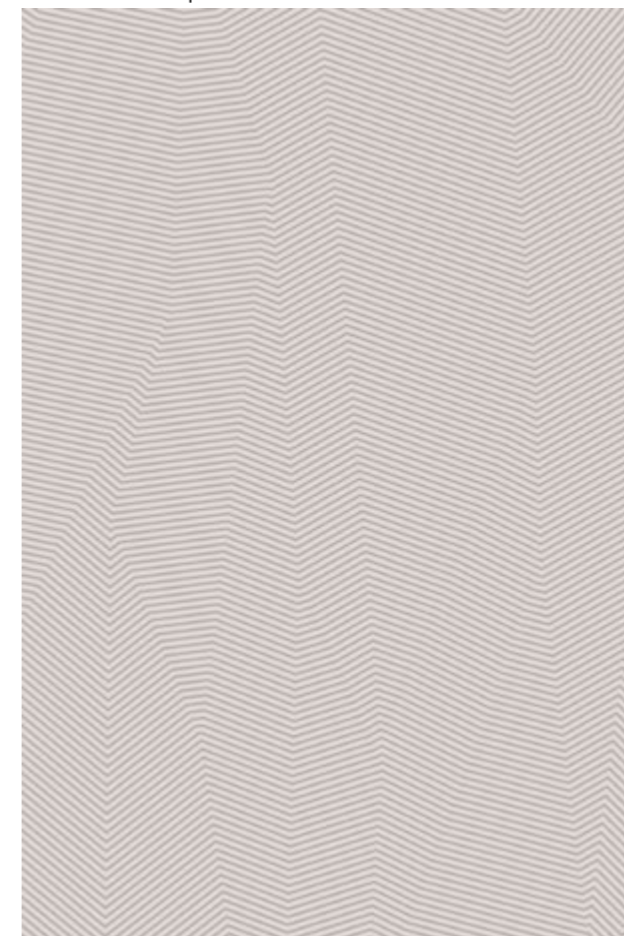



DAY LIGHT PATTERN B

Available as Rug, wall to wall  
 Design Frankly Amsterdam  
 Size Any size and shape possible  
 Weight 5800 gr/m2  
 Height 14 / 19 mm (Pattern B)  
 Technique Handtufted  
 Colors 10 Standard + 77 uni  
 Color design Christiane Müller  
 Material 100% Bamboo  
 Fire classification Cfl-s1  
 Advantages  
 + European production  
 + any size, color and shape possible  
 + custom patterns possible on request  
 + choose your pattern center point  
 + custom colors can be lab-dyed on request  
 + anti-bacterial and suitable for people with allergies



DAY LIGHT PATTERN B PRICE LIST

ARTICLE	ARTICLE CODE	COLOR	PRICE P/M <sup>2</sup>
Rug with pattern B	DAL6701-B	6701	€ 669,-
	DAL6702-B	6702	€ 669,-
	DAL6703-B	6703	€ 669,-
	DAL6704-B	6704	€ 669,-
	DAL6705-B	6705	€ 669,-
	DAL6706-B	6706	€ 669,-
	DAL6707-B	6707	€ 669,-
	DAL6708-B	6708	€ 669,-
	DAL6709-B	6709	€ 669,-
	DAL6710-B	6710	€ 669,-

PLEASE NOTE! Prices shown are public prices including VAT. The price per m<sup>2</sup> does not include the shipping costs. Click here to see the overview of shipping costs per country (page 3).

Pattern example 200 x 300 cm

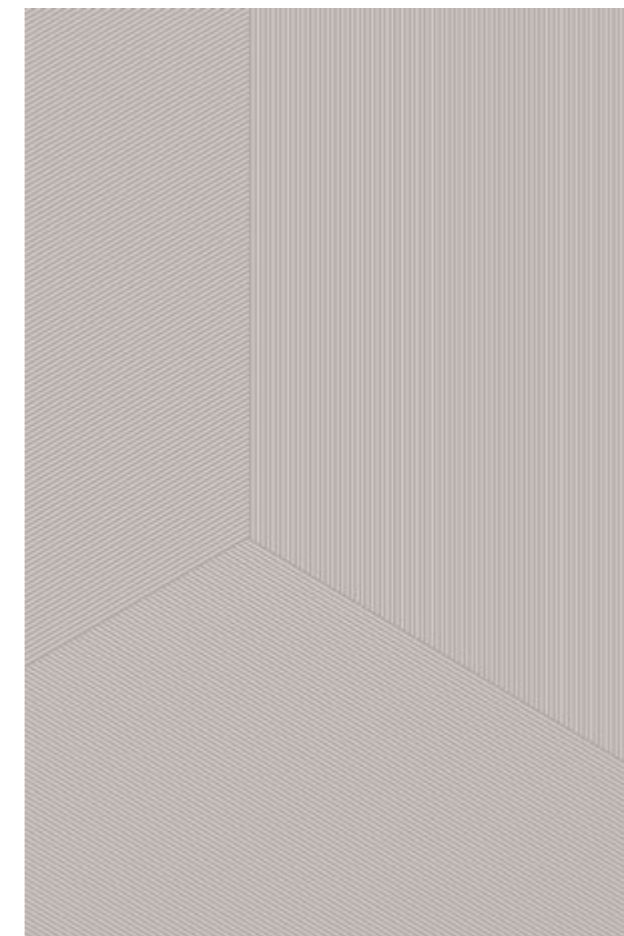



DAY LIGHT PATTERN C

Available as Rug, wall to wall  
 Design Frankly Amsterdam  
 Size Any size and shape possible  
 Weight 5800 gr/m2  
 Height 14 / 20 mm (Pattern C)  
 Technique Handtufted  
 Colors 10 Standard + 77 uni  
 Color design Christiane Müller  
 Material 100% Bamboo  
 Fire classification Cfl-s1  
 Advantages  
 + European production  
 + any size, color and shape possible  
 + custom patterns possible on request  
 + custom colors can be lab-dyed on request  
 + anti-bacterial and suitable for people with allergies



DAY LIGHT PATTERN C PRICE LIST

ARTICLE	ARTICLE CODE	COLOR	PRICE P/M <sup>2</sup>
Rug with pattern C	DAL6701-C	6701	€ 669,-
	DAL6702-C	6702	€ 669,-
	DAL6703-C	6703	€ 669,-
	DAL6704-C	6704	€ 669,-
	DAL6705-C	6705	€ 669,-
	DAL6706-C	6706	€ 669,-
	DAL6707-C	6707	€ 669,-
	DAL6708-C	6708	€ 669,-
	DAL6709-C	6709	€ 669,-
	DAL6710-C	6710	€ 669,-

PLEASE NOTE! Prices shown are public prices including VAT. The price per m<sup>2</sup> does not include the shipping costs. Click here to see the overview of shipping costs per country (page 3).

Pattern example 200 x 300 cm





DAY LIGHT PATTERN D (LOW)

Available as Rug, wall to wall  
 Design Frankly Amsterdam  
 Size Any size and shape possible  
 Weight 5800 gr/m2  
 Height 14/20 mm (stripes 20mm)  
 Technique Handtufted  
 Colors 10 Standard + 77 uni  
 Color design Christiane Müller  
 Material 100% Bamboo  
 Fire classification Cfl-s1  
 Advantages  
 + European production  
 + any size, color and shape possible  
 + choose the centerpoint of your pattern  
 + custom colors can be lab-dyed on request  
 + anti-bacterial and suitable for people with allergies



DAY LIGHT PATTERN D (LOW) PRICE LIST

ARTICLE	ARTICLE CODE	COLOR	PRICE P/M <sup>2</sup>
Rug with pattern D	DAL6701-D low	6701	€ 669,-
	DAL6702-D low	6702	€ 669,-
	DAL6703-D low	6703	€ 669,-
	DAL6704-D low	6704	€ 669,-
	DAL6705-D low	6705	€ 669,-
	DAL6706-D low	6706	€ 669,-
	DAL6707-D low	6707	€ 669,-
	DAL6708-D low	6708	€ 669,-
	DAL6709-D low	6709	€ 669,-
	DAL6710-D low	6710	€ 669,-

PLEASE NOTE! Prices shown are public prices including VAT. The price per m<sup>2</sup> does not include the shipping costs. Click here to see the overview of shipping costs per country (page 3).

Pattern example 200 x 300 cm

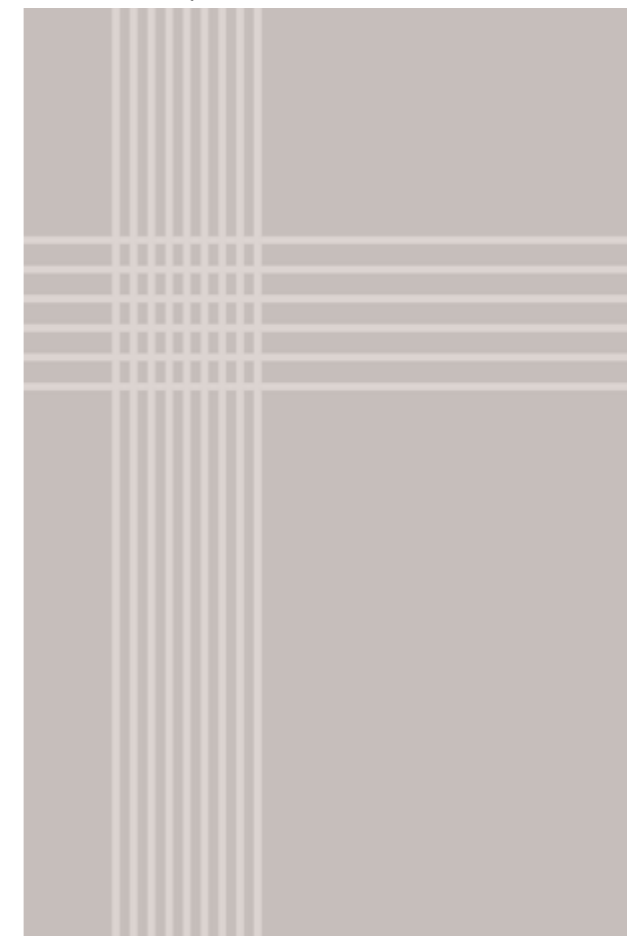





DAY LIGHT PATTERN D (HIGH)

Available as Rug, wall to wall  
 Design Frankly Amsterdam  
 Size Any size and shape possible  
 Weight 5800 gr/m<sup>2</sup>  
 Height 14/20 mm (stripes 14 mm)  
 Technique Handtufted  
 Colors 10 Standard + 77 uni  
 Color design Christiane Müller  
 Material 100% Bamboo  
 Fire classification Cfl-s1  
 Advantages  
 + European production  
 + any size, color and shape possible  
 + choose the centerpoint of your pattern  
 + custom colors can be lab-dyed on request  
 + anti-bacterial and suitable for people with allergies



DAY LIGHT PATTERN D (HIGH) PRICE LIST

ARTICLE	ARTICLE CODE	COLOR	PRICE P/M <sup>2</sup>
Rug with pattern D	DAL6701-D high	6701	€ 669,-
	DAL6702-D high	6702	€ 669,-
	DAL6703-D high	6703	€ 669,-
	DAL6704-D high	6704	€ 669,-
	DAL6705-D high	6705	€ 669,-
	DAL6706-D high	6706	€ 669,-
	DAL6707-D high	6707	€ 669,-
	DAL6708-D high	6708	€ 669,-
	DAL6709-D high	6709	€ 669,-
	DAL6710-D high	6710	€ 669,-

PLEASE NOTE! Prices shown are public prices including VAT. The price per m<sup>2</sup> does not include the shipping costs. Click here to see the overview of shipping costs per country (page 3).

Pattern example 200 x 300 cm:

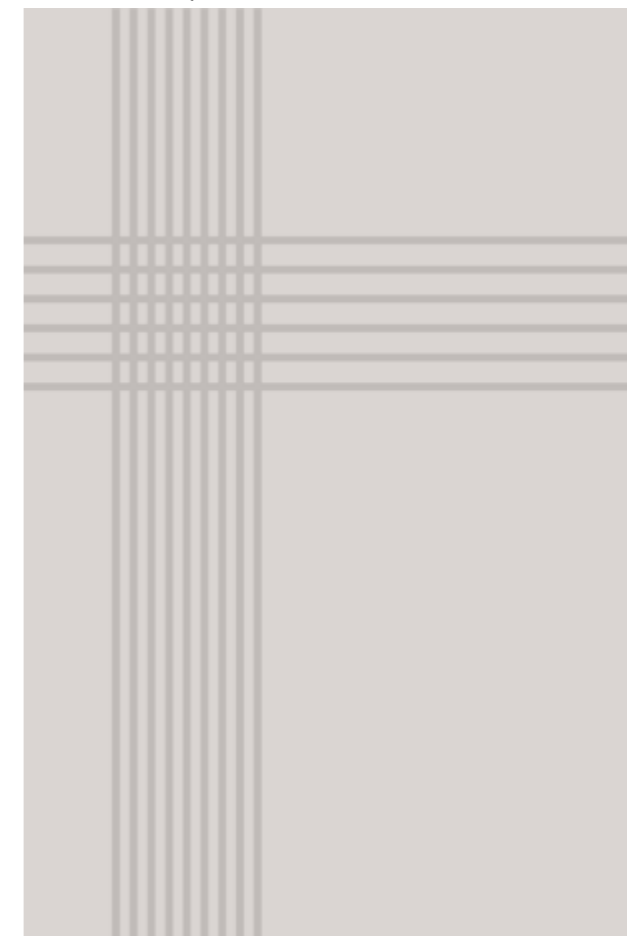



DONE DEAL PRICE LIST

ARTICLE	ARTICLE CODE	COLOR	PRICE P/M <sup>2</sup>
Rug	DOD7001	7001	€ 619,-
	DOD7002	7002	€ 619,-
	DOD7003	7003	€ 619,-
	DOD7004	7004	€ 619,-
	DOD7005	7005	€ 619,-
	DOD7006	7006	€ 619,-
	DOD7007	7007	€ 619,-
	DOD7008	7008	€ 619,-
	DOD7009	7009	€ 619,-

PLEASE NOTE! Prices shown are public prices including VAT. The price per m<sup>2</sup> does not include the shipping costs. Click here to see the overview of shipping costs per country (page 3).

DONE DEAL

Available as	Wall-to-wall
Pile surface	Cut Pile
Pile composition	50% Wool + 50% Eucalyptus
Carpet weight	± 3.500 g/m <sup>2</sup>
Pile height	12 mm
Backing	Natural latex + anti-slip
Fire classification	Cfl-s1
Colors	9 standard, custom colors available on request
Advantages	+ suitable for residential as well as soft contract + available as stair runner + possibility to create your own mix color out of 220 uni colors (see Eucalyptus box & Wool box) + long-lasting + custom colors available





LAND MARK

Available as Rug, wall-to-wall, runner  
 Design Diederik Dam  
 Size Any size possible, based on circles of 54 x 54 cm  
 Weight 6500 gr/m<sup>2</sup>  
 Height 12 - 25 mm  
 Technique Hand tufted and hand carved  
 Colors 8 Standard + 110 uni + any custom color  
 Color design Christiane Müller  
 Material 100% Mohair  
 Fire classification Bfl-s1  
 Advantages + suitable for residential as well as soft contract  
 + any size and shape possible  
 + exclusive design  
 + special graphic 3D look  
 + choose your own color (mix or uni) out of 110 uni colors (see Mohair color box)

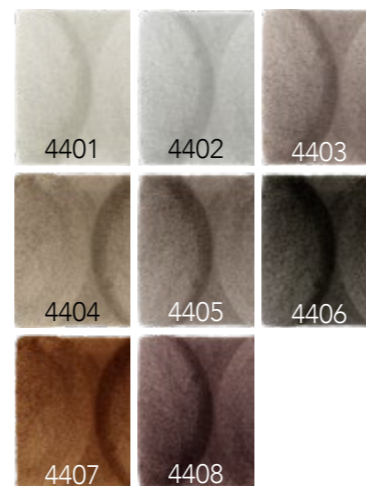

LAND MARK PRICE LIST

ARTICLE	ARTICLE CODE	COLOR	PRICE P/M <sup>2</sup>
Rug	LAM4401	4401	€ 975,-
	LAM4402	4402	€ 975,-
	LAM4403	4403	€ 975,-
	LAM4404	4404	€ 975,-
	LAM4405	4405	€ 975,-
	LAM4406	4406	€ 975,-
	LAM4407	4407	€ 975,-
	LAM4408	4408	€ 975,-

PLEASE NOTE! Prices shown are public prices including VAT. The price per m<sup>2</sup> does not include the shipping costs. Click here to see the overview of shipping costs per country (page 3).

Pattern example:

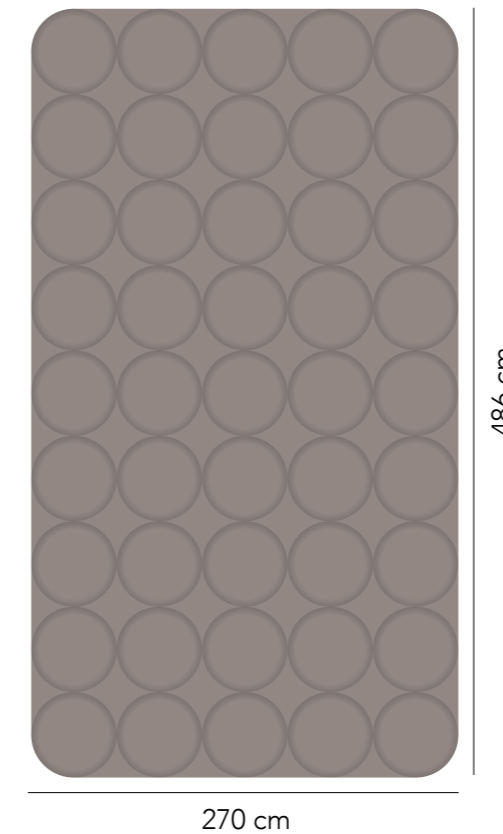

\* Rug size is always based on the size of the 54 x 54 cm circles



MOON PARTS

- Available as Rug
- Design Art in Return
- Size 170x255cm, 200x300cm, 235x350cm or 300x450cm or custom size in same ratio
- Weight 4000 gr/m<sup>2</sup>
- Height 12 - 45mm & 12 mm border
- Technique 3D Hand tufted with wool fringes on the short side
- Colors 1 standard color + any custom color
- Color design Art in Return
- Material 100% Wool
- Fire classification Bfl-s1
- Advantages
  - + any size possible within the same ratio.
  - + possibility to choose your own color out of 110 uni colors (see wool box)
  - + graphic design by Art in Return
  - + a strong and soft fiber
  - + naturally heat regulating, suitable in all seasons

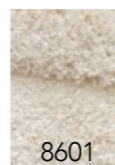

MOON PARTS PRICE LIST

ARTICLE	ARTICLE CODE	COLOR	PRICE P/M <sup>2</sup>
Rug	MOP8601	8601	€ 950,-

PLEASE NOTE! Prices shown are public prices including VAT. The price per m<sup>2</sup> does not include the shipping costs. Click here to see the overview of shipping costs per country (page 3).

Pattern in 200 x 300 cm





**MOVE SLOW**

Available as Rug, wall-to-wall, (stair)runner  
 Design Felix Diener & Frankly Amsterdam  
 Size Any size and shape possible  
 Weight 6000 gr/m<sup>2</sup>  
 Height 16 mm (standard) or custom height  
 Technique Hand tufted  
 Colors 8 Standard + 110 uni + any custom color  
 Color design Christiane Müller  
 Material 100% Eucalyptus  
 Fire classification Cfl-s1  
 Advantages  
 + any size, pattern and shape possible  
 + choose your own color (mix or uni) out of 110 uni colors (see Eucalyptus color box)  
 + custom colors can be lab-dyed on request (ask about the terms and possibilities)  
 + suitable for residential as well as soft contract



**MOVE SLOW PRICE LIST**

ARTICLE	ARTICLE CODE	COLOR	PRICE P/M <sup>2</sup>
Rug	MOS3501	3501	€ 649,-
	MOS3502	3502	€ 649,-
	MOS3503	3503	€ 649,-
	MOS3504	3504	€ 649,-
	MOS3505	3505	€ 649,-
	MOS3506	3506	€ 649,-
	MOS3507	3507	€ 649,-
	MOS3508	3508	€ 649,-

ARTICLE	ARTICLE CODE	PILE HEIGHT	PRICE P/M <sup>2</sup>
Rug	MOS-special (runner)	12mm	€ 649,-
	MOS-special	18-29 mm	€ 669,-
	MOS-special	30-39 mm	€ 719,-
	MOS-special	40-45 mm	€ 769,-

PLEASE NOTE! Prices shown are public prices including VAT. The price per m<sup>2</sup> does not include the shipping costs. Click here to see the overview of shipping costs per country (page 3).



**NEW START**

Available as Rug, wall-to-wall, (stair)runner  
 Design Frankly Amsterdam  
 Size Any size and shape possible  
 Weight 7.000 gr/m2  
 Height 12 mm (standard) or custom height up to 20 mm  
 Technique Hand tufted  
 Colors 35 standard + any custom color  
 Color design Frankly Amsterdam  
 Material 100% Biodegradable PET  
 Fire classification Bfl-s2  
 Advantages + any size, pattern and shape possible  
 + choose your own color (uni or mix up to 6 colors) out of 35 colors from our Biodegradable PET color box  
 + custom colors can be lab-dyed on request  
 + suitable for residential as well as contract



color box with 35 color options

**NEW START PRICE LIST**

ARTICLE	ARTICLE CODE	COLOR	PRICE P/M <sup>2</sup>
Rug	NST-1	1	€ 659,-
	NST-2	2	€ 659,-
	NST-3	3	€ 659,-
	NST-4	4	€ 659,-
	NST-5	5	€ 659,-
	up to NST-35	35	€ 659,-

ARTICLE	ARTICLE CODE	PILE HEIGHT	PRICE P/M <sup>2</sup>
Rug	NST-special (runner)	12mm	€ 659,-
	NST-special	10-16 mm	€ 659,-
	NST-special	17-20 mm*	€ 705,-

\* We recommend a maximum pile height of 20 mm due to the weight of the rug.

PLEASE NOTE! Prices shown are public prices including VAT. The price per m<sup>2</sup> does not include the shipping costs. Click here to see the overview of shipping costs per country (page 3).



**NEW START PATTERN A**

Available as	Rug, wall-to-wall, (stair)runner
Design	Frankly Amsterdam
Size	Any size and shape possible
Weight	4.800 gr/m <sup>2</sup>
Height	8 mm
Technique	Hand tufted
Colors	35 standard + any custom color
Color design	Frankly Amsterdam
Material	100% Biodegradable PET
Fire classification	Bfl-s2
Advantages	+ any size, pattern and shape possible + choose your own color (uni or mix up to 6 colors) out of 35 colors from our Biodegradable PET color box + custom colors can be lab-dyed on request + suitable for residential as well as contract



color box with 35 color options

**NEW START PATTERN A PRICE LIST**

ARTICLE	ARTICLE CODE	COLOR	PRICE P/M <sup>2</sup>
Rug	NST1-A	1	€ 675,-
	NST2-A	2	€ 675,-
	NST3-A	3	€ 675,-
	NST4-A	4	€ 675,-
	NST5-A	5	€ 675,-
	up to NST35-A	35	€ 675,-

PLEASE NOTE! Prices shown are public prices including VAT. The price per m<sup>2</sup> does not include the shipping costs. Click here to see the overview of shipping costs per country (page 3).



**NIGHT FIRE**

Available as Rug, wall-to-wall, (stair)runner  
 Design Nicemakers  
 Size Any size and shape possible  
 Weight 5500 gr/m<sup>2</sup>  
 Height 16 mm  
 Technique Hand tufted  
 Colors 8 Standard  
 Color design Nicemakers  
 Material 65% Eucalyptus, 35% Bamboo  
 Fire classification Cfl-s1  
 Advantages + any size and shape possible  
 + handtufted  
 + available in 8 standard colors or in pattern  
 + delivery time for the rug in pattern is 6 weeks



**NIGHT FIRE PRICE LIST**

ARTICLE	ARTICLE CODE	COLOR	PRICE P/M <sup>2</sup>
Rug	NIF5501	5501	€ 689,-
	NIF5502	5502	€ 689,-
	NIF5503	5503	€ 689,-
	NIF5504	5504	€ 689,-
	NIF5505	5505	€ 689,-
	NIF5506	5506	€ 689,-
	NIF5507	5507	€ 689,-
	NIF5508	5508	€ 689,-

PLEASE NOTE! Prices shown are public prices including VAT. The price per m<sup>2</sup> does not include the shipping costs. Click here to see the overview of shipping costs per country (page 3).





ON RETURN

- Available as Rug, wall-to-wall, (stair)runner
- Pile surface Tip-shear
- Pile composition 100% recycled plastic
- Shape Rectangular or circular
- Pile weight ± 1.900 g/m<sup>2</sup>
- Carpet weight ± 2.800 g/m<sup>2</sup>
- Pile height 9 mm
- Backing Jute & latex
- Roll width 2 or 4 meter
- Fire classification Cfl-s1
- Colors 12 standard, custom colors available on request from 200 m<sup>2</sup>
- Advantages
  - + suitable for residential as well as contract
  - + made from regenerated nylon
  - + environmentally friendly & sustainable
  - + long-lasting & fire retardant
  - + castor proof



ON RETURN PRICE LIST

ARTICLE	ARTICLE CODE	COLOR	PRICE P/M <sup>2</sup> WITH OVERLOCK EDGE*
Rug	ONR6001	6001	€ 345,-
	ONR6002	6002	€ 345,-
	ONR6003	6003	€ 345,-
	ONR6004	6004	€ 345,-
	ONR6005	6005	€ 345,-
	ONR6006	6006	€ 345,-
	ONR6007	6007	€ 345,-
	ONR6008	6008	€ 345,-
	ONR6009	6009	€ 345,-
	ONR6010	6010	€ 345,-
	ONR6011	6011	€ 345,-
	ONR6012	6012	€ 345,-

Your rug will be cut from a roll of 2 meters or 4 meters width. Please include the cutting loss in your order. If you need any help calculating this, we are glad to be of service. Rectangle, square and round shapes are possible. For prices and special shapes please contact us.

\* [Click here to see the overview of our edge finishing options and maximum rug sizes.](#)

PLEASE NOTE! Prices shown are public prices including VAT. The price per m<sup>2</sup> does not include the shipping costs. [Click here to see the overview of shipping costs per country \(page 3\).](#)

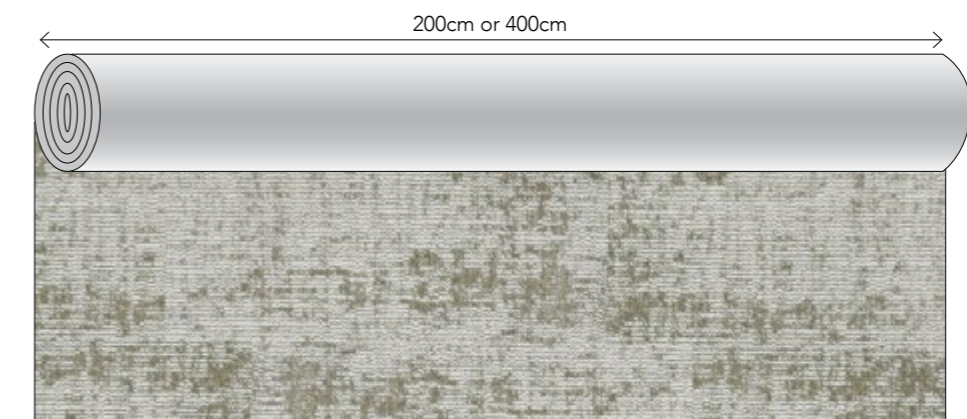

This pattern is not on scale, this image only shows the pattern direction



PERFECT MATCH PRICE LIST

ARTICLE	ARTICLE CODE	COLOR	PRICE P/M <sup>2</sup>
Rug	PEM2001	2001	€ 729,-
	PEM2002	2002	€ 729,-
	PEM2003	2003	€ 729,-
	PEM2004	2004	€ 729,-
	PEM2005	2005	€ 729,-
	PEM2006	2006	€ 729,-
	PEM2007	2007	€ 729,-
	PEM2008	2008	€ 729,-

PLEASE NOTE! Prices shown are public prices including VAT. The price per m<sup>2</sup> does not include the shipping costs. Click here to see the overview of shipping costs per country (page 3).

PERFECT MATCH

Available as Rug, wall-to-wall, (stair)runner  
 Design Ulf Moritz  
 Size Any size and shape possible  
 Weight 5000 gr/m<sup>2</sup>  
 Height 12 mm (standard)  
 Technique Hand tufted  
 Colors 8 Standard + 110 uni + any custom color  
 Color design Christiane Müller  
 Material 80% Eucalyptus, 20% Wool  
 Fire classification Eucalyptus Cfl-s1, Wool Bfl-s1  
 Advantages  
 + any size, pattern and shape possible  
 + choose your own color (mix or uni) out of 110 uni colors (see Eucalyptus color box)  
 + custom colors can be lab-dyed on request (ask about the terms and possibilities)  
 + suitable for residential as well as soft contract





SAINT CLOUD PRICE LIST

ARTICLE	ARTICLE CODE	COLOR	PRICE P/M <sup>2</sup>
Rug	SAC5801	5801	€ 919,-
	SAC5802	5802	€ 919,-
	SAC5803	5803	€ 919,-
	SAC5804	5804	€ 919,-
	SAC5805	5805	€ 919,-
	SAC5806	5806	€ 919,-
	SAC5807	5807	€ 919,-

PLEASE NOTE! Prices shown are public prices including VAT. The price per m<sup>2</sup> does not include the shipping costs. Click here to see the overview of shipping costs per country (page 3).

SAINT CLOUD

Available as Rug, wall-to-wall  
 Design Frankly Amsterdam  
 Size Any size and shape possible  
 Weight 3500 gr/m<sup>2</sup>  
 Height 18 mm, with shaven or unshaven finish  
 Technique Hand tufted  
 Colors 7 standard  
 Color design Christiane Müller  
 Material 100% Merino Wool  
 Advantages + any size and shape possible  
 + available with shaven or unshaven finish  
 + environmentally friendly & sustainable  
 + long-lasting & fire retardant





SECOND NATURE

Available as Rug  
 Design Els van Egmond  
 Size Any size possible  
 Weight 4200 gr/m<sup>2</sup>  
 Height 14 + 18 mm, or custom height  
 Technique Hand tufted  
 Colors 10 Standard + any custom color  
 Color design Christiane Müller  
 Material 100% Mohair  
 Fire classification Bfl-s1  
 Advantages + any size possible, 3 shapes possible  
 + choose your own color (mix or uni) out of 110 uni colors (see Mohair color box)  
 + custom colors can be lab-dyed on request (ask about the terms and possibilities)  
 + suitable for residential as well as soft contract



SECOND NATURE PRICE LIST

ARTICLE	ARTICLE CODE	COLOR	PRICE P/M <sup>2</sup>
Rug	SEN6401 A, B or C	6401	€ 825,-
	SEN6402 A, B or C	6402	€ 825,-
	SEN6403 A, B or C	6403	€ 825,-
	SEN6404 A, B or C	6404	€ 825,-
	SEN6405 A, B or C	6405	€ 825,-
	SEN6406 A, B or C	6406	€ 825,-
	SEN6407 A, B or C	6407	€ 825,-
	SEN6408 A, B or C	6408	€ 825,-
	SEN6409 A, B or C	6409	€ 825,-
	SEN6410 A, B or C	6410	€ 825,-

PLEASE NOTE! Prices shown are public prices including VAT. The price per m<sup>2</sup> does not include the shipping costs. Click here to see the overview of shipping costs per country (page 3).

Please see below example of the calculated m<sup>2</sup> per shape:

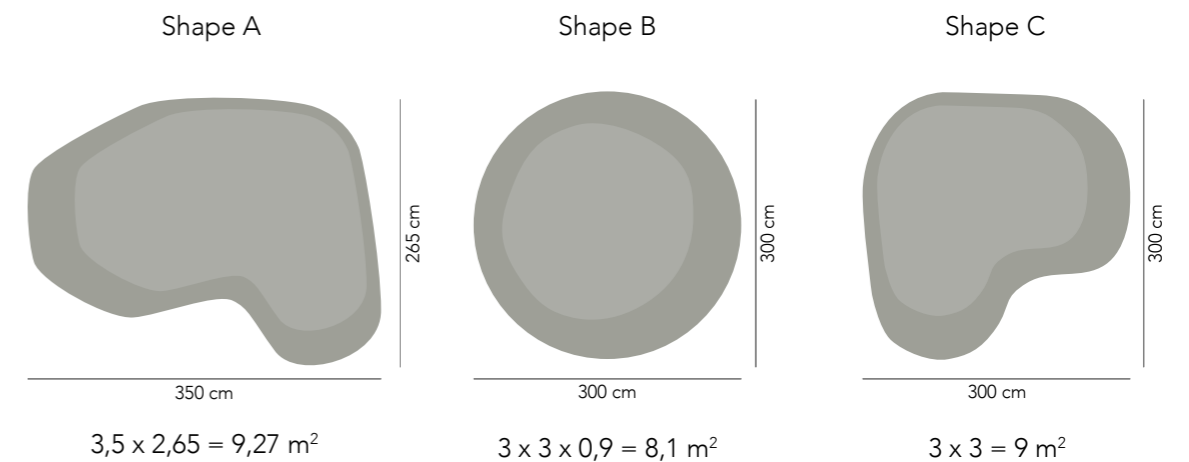



SHOW OFF

Available as Rug, wall-to-wall, runner  
 Design Frankly Amsterdam  
 Size Any size and shape possible  
 Weight 5700 gr/m<sup>2</sup>  
 Height 40 mm  
 Technique Hand tufted  
 Colors 9 Standard + any custom color  
 Color design Christiane Müller  
 Material 50% Mohair, 50% Bamboo  
 Fire classification Mohair Bfl-s1, Bamboo Cfl-s1  
 Advantages + suitable for residential as well as soft contract  
 + any size and shape possible  
 + choose your own color (see Mohair and Bamboo color box)  
 + environmentally friendly & sustainable  
 + extremely breathable



SHOW OFF PRICE LIST

ARTICLE	ARTICLE CODE	COLOR	PRICE P/M <sup>2</sup>
Rug	SHO5601	5601	€ 699,-
	SHO5602	5602	€ 699,-
	SHO5603	5603	€ 699,-
	SHO5604	5604	€ 699,-
	SHO5605	5605	€ 699,-
	SHO5606	5606	€ 699,-
	SHO5607	5607	€ 699,-
	SHO5608	5608	€ 699,-
	SHO5609	5609	€ 699,-

ARTICLE	ARTICLE CODE	PILE HEIGHT	PRICE P/M <sup>2</sup>
Rug	SHO-special	up to 18 mm	€ 655,-
	SHO-special	20-29 mm	€ 679,-
	SHO-special	30-39 mm	€ 690,-
	SHO-special	40-45 mm	€ 699,-

PLEASE NOTE! Prices shown are public prices including VAT. The price per m<sup>2</sup> does not include the shipping costs. Click here to see the overview of shipping costs per country (page 3).



SHOW OFF GRADIENT

Available as Rug, wall-to-wall, runner  
 Design Frankly Amsterdam  
 Size Any size and shape possible  
 Weight 5700 gr/m2  
 Height 40 mm  
 Technique Hand tufted  
 Colors 2 Standard + any custom color  
 Color design Frankly Amsterdam  
 Material 50% Mohair, 50% Bamboo  
 Fire classification Mohair Bfl-s1, Bamboo Cfl-s1  
 Advantages + suitable for residential as well as soft contract  
 + any size and shape possible  
 + choose your own color (see Mohair and Bamboo color box)  
 + environmentally friendly & sustainable  
 + extremely breathable

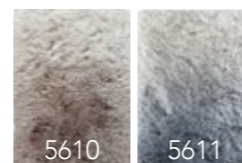

SHOW OFF GRADIENT PRICE LIST

ARTICLE	ARTICLE CODE	COLOR	PRICE P/M <sup>2</sup>
Rug	SHO5610	5610	€ 899,-
	SHO5611	5611	€ 899,-

Or request your custom color! [Click here to see our Gradients price list.](#)

PLEASE NOTE! Prices shown are public prices including VAT. The price per m<sup>2</sup> does not include the shipping costs. [Click here to see the overview of shipping costs per country \(page 3\).](#)



STEP UP 16

Available as Rug, wall-to-wall  
 Pile surface Cut Pile  
 Pile composition 100% Pure New Wool  
 Shape Rectangular or circular  
 Pile weight ± 2.525 g/m<sup>2</sup>  
 Carpet weight ± 4.025 g/m<sup>2</sup>  
 Pile height 14 mm  
 Backing Action Back P.P.  
 Roll width 2 or 4 meter  
 Fire classification Cfl-s1  
 Colors 9 standard colors, custom colors available on request from 100 m<sup>2</sup>  
 Advantages + suitable for residential as well as contract  
 + long-lasting & fire retardant  
 + VOC-emission label A+



STEP UP 16 PRICE LIST

ARTICLE	ARTICLE CODE	COLOR	RUG WITH SHAVEN EDGE*
Rug	STU6201	6201	€ 465,-
	STU6202	6202	€ 465,-
	STU6203	6203	€ 405,-
	STU6204	6204	€ 405,-
	STU6205	6205	€ 405,-
	STU6206	6206	€ 405,-
	STU6207	6207	€ 405,-
	STU6208	6208	€ 405,-
	STU6209	6209	€ 405,-

Your rug will be cut from a roll of 2 meters or 4 meters width. Please include the cutting loss in your order. If you need any help calculating this, we are glad to be of service.

\* [Click here to see the overview page with our edge finishing options..](#)

PLEASE NOTE! Prices shown are public prices including VAT. The price per m<sup>2</sup> does not include the shipping costs. [Click here to see the overview of shipping costs per country \(page 3\).](#)



STEP UP 9

Available as Rug, wall-to-wall  
 Pile surface Cut Pile  
 Pile composition 100% Pure New Wool  
 Shape Rectangular or circular  
 Pile weight ± 1.350 g/m<sup>2</sup>  
 Carpet weight ± 2.850 g/m<sup>2</sup>  
 Pile height 7,2 mm  
 Backing Action Back P.P.  
 Roll width 2 or 4 meter  
 Fire classification Bfl-s1  
 Colors 20 standard colors, custom colors available on request from 200 m<sup>2</sup>  
 Advantages + available as stair runner  
 + suitable for residential as well as contract  
 + long-lasting & fire retardant  
 + VOC-emission label A+

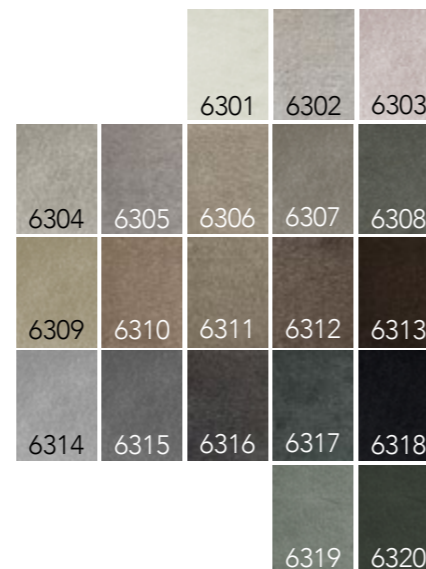

STEP UP 9 PRICE LIST

ARTICLE	ARTICLE CODE	COLOR	RUG WITH OVERLOCK EDGE*
Rug	STU6301	6301	€ 265,-
	STU6302	6302	€ 265,-
	STU6303	6303	€ 265,-
	STU6304	6304	€ 235,-
	STU6305	6305	€ 235,-
	STU6306	6306	€ 235,-
	STU6307	6307	€ 235,-
	STU6308	6308	€ 235,-
	STU6309	6309	€ 235,-
	STU6310	6310	€ 235,-
	STU6311	6311	€ 235,-
	STU6312	6312	€ 235,-
	STU6313	6313	€ 235,-
	STU6314	6314	€ 235,-
	STU6315	6315	€ 235,-
	STU6316	6316	€ 235,-
	STU6317	6317	€ 235,-
	STU6318	6318	€ 235,-
	STU6319	6319	€ 235,-
	STU6320	6320	€ 235,-

Your rug will be cut from a roll of 2 meters or 4 meters width. Please include the cutting loss in your order. If you need any help calculating this, we are glad to be of service.

\* [Click here to see the overview page with our edge finishing options.](#)

PLEASE NOTE! Prices shown are public prices including VAT. The price per m<sup>2</sup> does not include the shipping costs. [Click here to see the overview of shipping costs per country \(page 3\).](#)





**SUPER MOON**

Available as Rug, wall-to-wall, (stair)runner  
 Design Frankly Amsterdam  
 Size Any size and shape possible  
 Weight 5500 gr/m<sup>2</sup>  
 Height 18 mm (standard) or custom height  
 Technique Hand tufted  
 Colors 9 Standard + 110 uni + any custom color  
 Material 100% Mohair  
 Fire classification Bfl-s1  
 Advantages + any size, pattern and shape possible  
 + choose your own color (mix or uni) out of 110 uni colors (see Mohair color box)  
 + custom colors can be lab-dyed on request (ask about the terms and possibilities)  
 + suitable for residential as well as soft contract

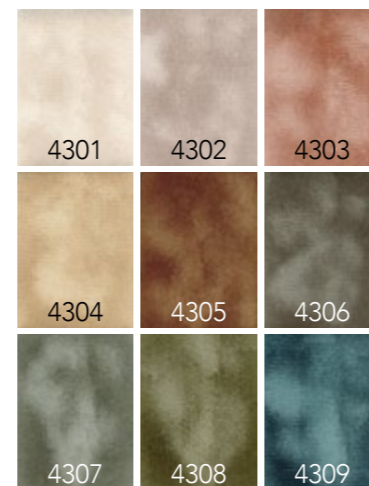

**SUPER MOON PRICE LIST**

ARTICLE	ARTICLE CODE	COLOR	PRICE P/M <sup>2</sup>
Rug	SUM4301	4301	€ 669,-
	SUM4302	4302	€ 669,-
	SUM4303	4303	€ 669,-
	SUM4304	4304	€ 669,-
	SUM4305	4305	€ 669,-
	SUM4306	4306	€ 669,-
	SUM4307	4307	€ 669,-
	SUM4308	4308	€ 669,-
	SUM4309	4309	€ 669,-

ARTICLE	ARTICLE CODE	PILE HEIGHT	PRICE P/M <sup>2</sup>
Rug	SUM-special (runner)	12mm	€ 669,-
	SUM-special	up to 18 mm	€ 669,-
	SUM-special	20-29 mm	€ 719,-
	SUM-special	30-39 mm	€ 759,-
	SUM-special	40-45 mm	€ 779,-

PLEASE NOTE! Prices shown are public prices including VAT. The price per m<sup>2</sup> does not include the shipping costs. Click here to see the overview of shipping costs per country (page 3).



**SUPER MOON 45**

Available as Rug, wall-to-wall, runner  
 Design Frankly Amsterdam  
 Size Any size and shape possible  
 Weight 6000 gr/m<sup>2</sup>  
 Height 45 mm (standard) or custom height  
 Technique Hand tufted  
 Colors 9 Standard + 110 uni + any custom color  
 Material 100% Mohair  
 Fire classification Bfl-s1  
 Advantages + any size, pattern and shape possible  
 + choose your own color (mix or uni) out of 110 uni colors (see Mohair color box)  
 + custom colors can be lab-dyed on request (ask about the terms and possibilities)  
 + suitable for residential as well as soft contract

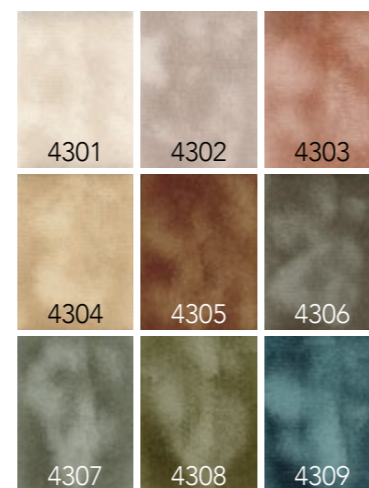

**SUPER MOON 45 PRICE LIST**

ARTICLE	ARTICLE CODE	COLOR	PRICE P/M <sup>2</sup>
Rug	SUM45 4301	4301	€ 779,-
	SUM45 4302	4302	€ 779,-
	SUM45 4303	4303	€ 779,-
	SUM45 4304	4304	€ 779,-
	SUM45 4305	4305	€ 779,-
	SUM45 4306	4306	€ 779,-
	SUM45 4307	4307	€ 779,-
	SUM45 4308	4308	€ 779,-
	SUM45 4309	4309	€ 779,-

PLEASE NOTE! Prices shown are public prices including VAT. The price per m<sup>2</sup> does not include the shipping costs. Click here to see the overview of shipping costs per country (page 3).



**THINK BIG**

Available as	Rug
Design	Frankly Amsterdam
Size	All sizes possible
Weight	5500 gr/m <sup>2</sup>
Height	12 mm + 45 mm
Technique	Handtufted
Colors	1 Standard, custom colors on request
Color design	Frankly Amsterdam
Material	Eucalyptus (center) & Mohair (border)
Fire classification	Eucalyptus Cf-s1, Mohair Bfl-s1
Advantages	+ delivery time for this rug is 6 weeks + all sizes possible + eye-catching higher border with rounded corners + high quality Mohair and Eucalyptus yarn + suitable for residential as well as soft contract



**THINK BIG PRICE LIST**

ARTICLE	ARTICLE CODE	COLOR	PRICE P/M <sup>2</sup>
Rug	THB6901	6901	€ 799,-

PLEASE NOTE! Prices shown are public prices including VAT. The price per m<sup>2</sup> does not include the shipping costs. Click here to see the overview of shipping costs per country (page 3).



UN FOLD PRICE LIST

ARTICLE	ARTICLE CODE	COLOR	PRICE P/M <sup>2</sup>
Rug	UNF8501	8501	€ 799,-
	UNF8502	8502	€ 799,-
	UNF8503	8503	€ 799,-
	UNF8504	8504	€ 799,-
	UNF8505	8505	€ 799,-
	UNF8506	8506	€ 799,-
	UNF8507	8507	€ 799,-

PLEASE NOTE! Prices shown are public prices including VAT. The price per m<sup>2</sup> does not include the shipping costs. Click here to see the overview of shipping costs per country (page 3).

UN FOLD

Available as Rug, wall-to-wall, runner  
 Design Frankly Amsterdam  
 Size Any size possible  
 Weight 4700 gr/m<sup>2</sup>  
 Height 14/20 mm  
 Technique Hand tufted  
 Colors 7 Standard + 110 uni + any custom color  
 Color design Christiane Müller  
 Material 100% Mohair  
 Fire classification Bfl-s1  
 Advantages  
 + any size and shape possible  
 + possibility to create your own color (mix or uni)  
 out of 110 uni colors from our Mohair colorbox  
 + custom colors can be lab-dyed on request  
 + suitable for residential as well as soft contract





GRADIENTS (MOVE SLOW, SUPER MOON AND SHOW OFF)

Available as	Rug, (stair)runner
Design	Frankly Amsterdam
Size	Any size and shape possible
Height and weight	Move Slow gradient 16 mm, 6000 gr/m <sup>2</sup> , Super Moon gradient 18 mm, 5000 gr/m <sup>2</sup> , Show Off gradient 40 mm, 5700 gr/m <sup>2</sup> , or request a custom height
Technique	Hand tufted
Colors	Select a start and end color for your custom gradient (minimum 2 colors)
Material	Move Slow gradient 100% Eucalyptus, Super Moon gradient Mohair Show Off gradient 50% Mohair, 50% Bamboo
Advantages	+ any size, pattern and shape possible + choose your own color from our color boxes + gradients can be linear, radial or organic + suitable for residential as well as soft contract

GRADIENT PRICE LIST FOR MOVE SLOW, SUPER MOON AND SHOW OFF

ARTICLE	ARTICLE CODE	COLOR	PRICE P/M <sup>2</sup>
Move Slow rug, (stair)runner	MOS gradient	choose 2 or more colors from our Eucalyptus colorbox	from € 899,- *
Super Moon rug, (stair)runner	SUM gradient	choose 2 or more colors from our Mohair colorbox	from € 899,- *
Show Off rug, runner	SHO gradient	choose 2 or more colors from our Bamboo or Mohair colorbox	from € 899,- *

\* Prices are based on a gradient with 2 colors in the similar color tone (as shown on the left page). For more complex gradients with multiple colors we will perform a color study with a custom price.

PLEASE NOTE! Prices shown are public prices including VAT. The price per m<sup>2</sup> does not include the shipping costs. Click here to see the overview of shipping costs per country (page 3).

FRANKLY  
AMSTERDAM

WOVEN RUGS



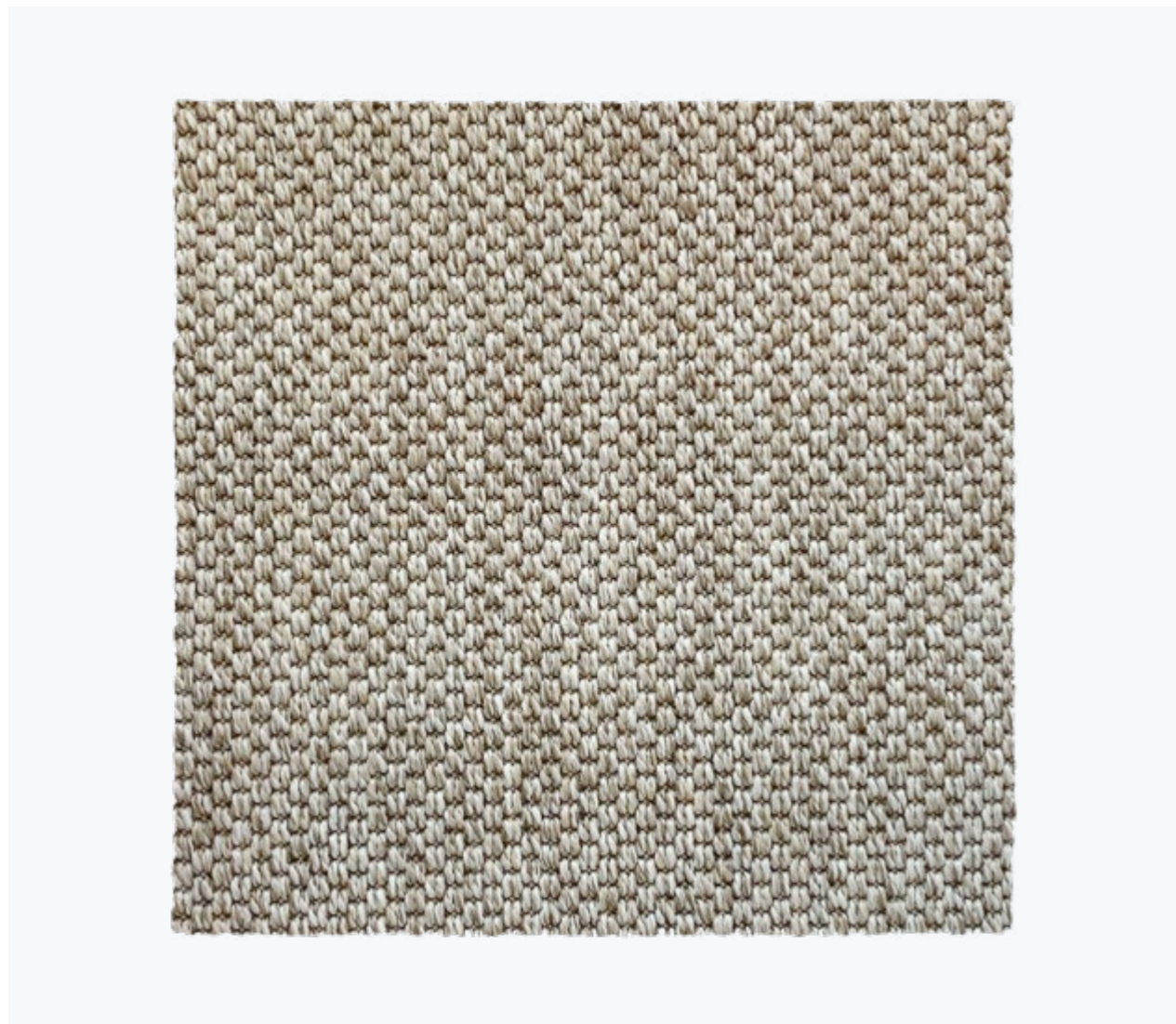

**ALL STAR**

Available as Rug, wall-to-wall, (stair)runner  
 Pile surface Loop pile  
 Pile composition 100% P.P.  
 Size 4m width, up to 30m length  
 Shape Rectangular or circular  
 Carpet weight ± 1.650 g/m<sup>2</sup>  
 Carpet thickness ± 5 mm  
 Backing Gel backing. Color 8801 and 8808 have a Precoat Latex backing  
 Roll width 4 meter  
 Fire classification Cfl-s1 / Efl for color 8801 and 8808  
 Colors 11 standard  
 Advantages + suitable for indoor and outdoor use  
 + suitable for residential and contract  
 + waterproof, UV proof and easy cleaning  
 + castor proof  
 Note Rubber underlayment is highly recommended for all wall-to-wall installations and area rugs



**ALL STAR PRICE LIST**

ARTICLE	ARTICLE CODE	COLOR	PRICE P/M <sup>2</sup> WITH OVERLOCK EDGE*	PRICE P/M <sup>2</sup> WITH PADDED FOLDED EDGE*
Rug	ALS8801	8801	€ 209,-	€ 333,-
	ALS8802	8802	€ 209,-	€ 333,-
	ALS8803	8803	€ 209,-	€ 333,-
	ALS8804	8804	€ 209,-	€ 333,-
	ALS8805	8805	€ 209,-	€ 333,-
	ALS8806	8806	€ 209,-	€ 333,-
	ALS8807	8807	€ 209,-	€ 333,-
	ALS8808	8808	€ 209,-	€ 333,-
	ALS8809	8809	€ 209,-	€ 333,-
	ALS8810	8810	€ 209,-	€ 333,-
	ALS8811	8811	€ 209,-	€ 333,-

Your rug will be cut from a roll of 4 meters width. Please include the cutting loss in your order. If you need any help calculating this, we are glad to be of service. Rectangle, square and round shapes are possible. For prices and special shapes please contact us.

\* [Click here to see the overview of our edge finishing options and maximum rug sizes.](#)

Rugs with a folded padded edge will have felted padding at the bottom, therefore they can only be used indoors and can not be used for stair runners. Please calculate a 10 cm margin around all edges for a rug with folded padded edge. Max. rug width for this finish is 380 cm.

PLEASE NOTE! Prices shown are public prices including VAT. The price per m<sup>2</sup> does not include the shipping costs. [Click here to see the overview of shipping costs per country \(page 3\).](#)

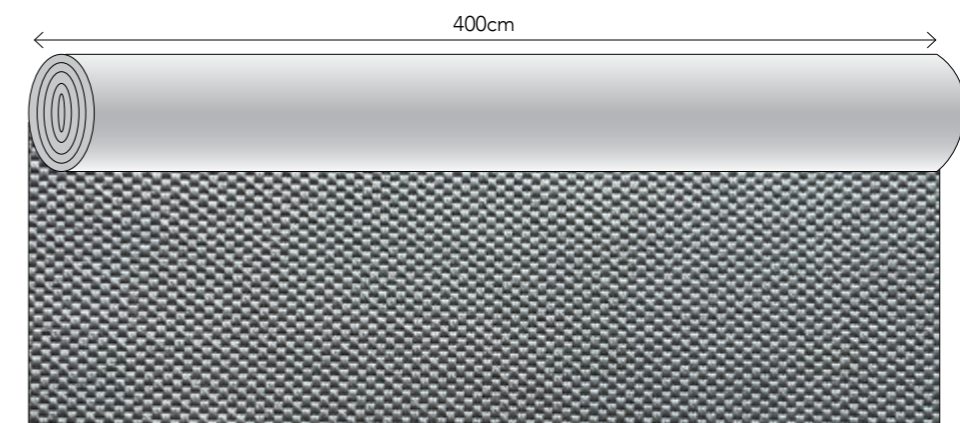

This pattern is not on scale, this image only shows the pattern direction



BOTTOM LINE PRICE LIST

ARTICLE	ARTICLE CODE	COLOR	PRICE P/M <sup>2</sup>
Rug	BOL5001	5001	€ 799,-
	BOL5002	5002	€ 799,-
	BOL5003	5003	€ 799,-
	BOL5004	5004	€ 799,-
	BOL5005	5005	€ 799,-
	BOL5006	5006	€ 799,-

PLEASE NOTE! Prices shown are public prices including VAT. The price per m<sup>2</sup> does not include the shipping costs. Click here to see the overview of shipping costs per country (page 3).

BOTTOM LINE

Available as Rug, runner  
 Design Frankly Amsterdam  
 Size Maximum width 5 meter, infinite length  
 Technique Handwoven  
 Colors 6 Standard + 161 uni  
 Color design Christiane Müller  
 Material 25% Eucalyptus, 75% Virgin Wool  
 Endings Plain ending: Blind ending:



Fire classification Eucalyptus Cfl-s1, Virgin Wool Bfl-s1  
 Advantages + European production  
 + any size possible  
 + maximum width 5 meters  
 + 110 Wool- and 51 Eucalyptus colors to choose from  
 + suitable for residential as well as soft contract





EAGLE EYE PRICE LIST

ARTICLE	ARTICLE CODE	COLOR	PRICE P/M <sup>2</sup>
Rug	EAE5101	5101	€ 829,-
	EAE5102	5102	€ 829,-
	EAE5103	5103	€ 829,-
	EAE5104	5104	€ 829,-
	EAE5105	5105	€ 829,-
	EAE5106	5106	€ 829,-
	EAE5107	5107	€ 829,-

PLEASE NOTE! Prices shown are public prices including VAT. The price per m<sup>2</sup> does not include the shipping costs. Click here to see the overview of shipping costs per country (page 3).

EAGLE EYE

Available as Rug, (stair)runner  
 Design Frankly Amsterdam  
 Size Maximum width 5 meter, infinite length  
 Technique Handwoven  
 Colors 7 Standard + 110 uni  
 Color design Christiane Müller  
 Material 100% Wool  
 Endings Plain ending: Blind ending:



Fire classification Bfl-s1  
 Advantages  
 + European production  
 + Any size possible  
 + maximum width 5 meters  
 + 110 Wool colors to choose from  
 + suitable for residential as well as soft contract



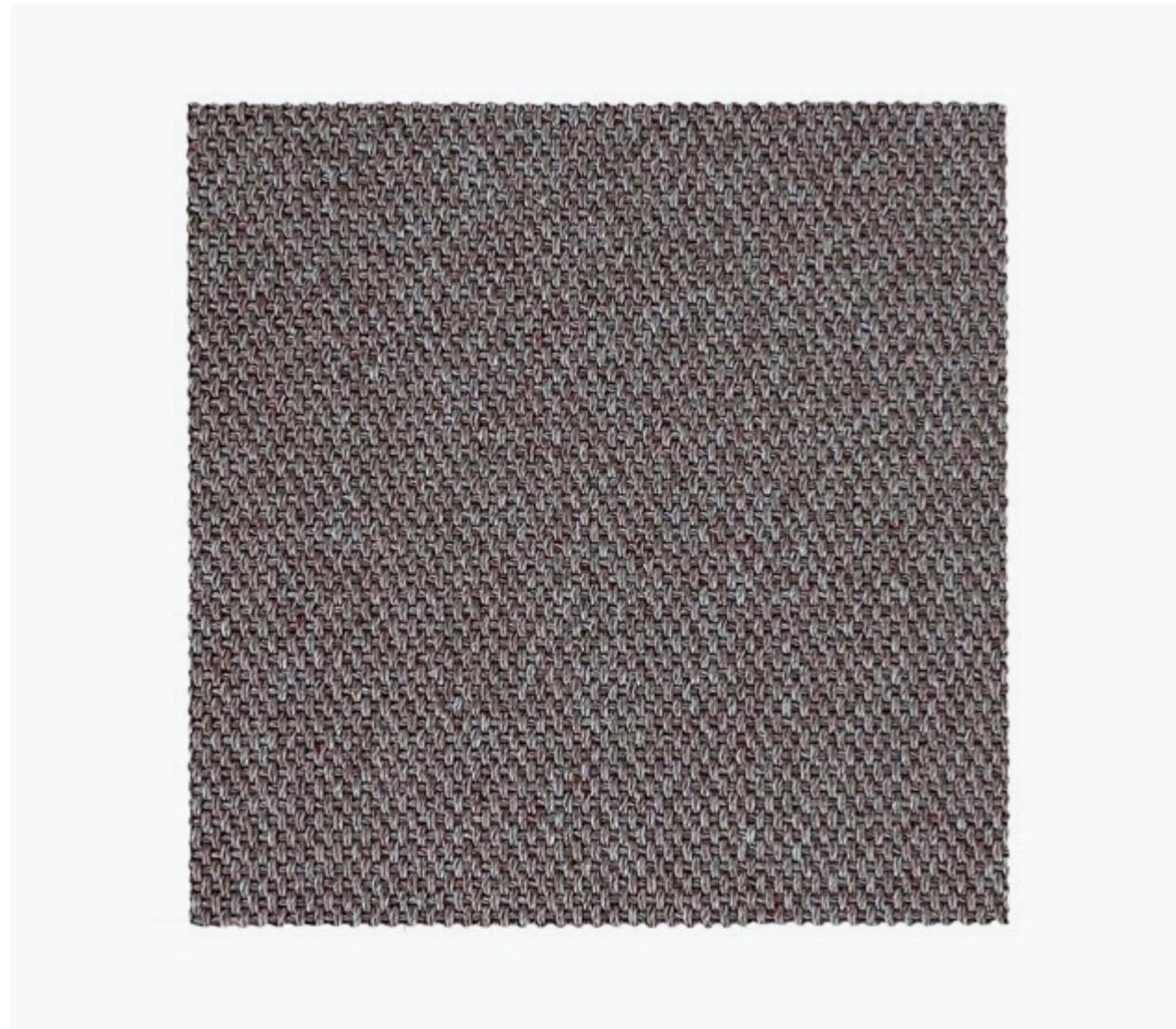

**EASY GOING**

Available as	Rug, wall-to-wall, (stair)runner
Pile surface	Loop pile
Pile composition	100% Recycled PET
Size	Maximum 4m width, up to 32m length
Shape	Rectangular or circular
Carpet weight	± 2.400 g/m <sup>2</sup>
Carpet thickness	± 4 mm
Backing	P.P. + Latex
Roll width	2 or 4 meter
Fire classification	Dfl-s1
Colors	6 standard
Advantages	+ suitable for indoor and outdoor use + suitable for residential and contract + waterproof and UV proof + easy cleaning, even with diluted bleach + castor proof
Note	Rubber underlayment is highly recommended for all wall-to-wall installations and area rugs



**EASY GOING PRICE LIST**

ARTICLE	ARTICLE CODE	COLOR	PRICE P/M <sup>2</sup> WITH OVERLOCK EDGE*	PRICE P/M <sup>2</sup> WITH BORDER*
Rug	EAG7401	7401	€ 235,-	€ 299,-
	EAG7402	7402	€ 235,-	€ 299,-
	EAG7403	7403	€ 235,-	€ 299,-
	EAG7404	7404	€ 235,-	€ 299,-
	EAG7405	7405	€ 235,-	€ 299,-
	EAG7406	7406	€ 235,-	€ 299,-

Your rug will be cut from a roll of 2 meters or 4 meters width. Please include the cutting loss in your order. If you need any help calculating this, we are glad to be of service. Rectangle, square and round shapes are possible. For prices and special shapes please contact us.

Depending on your requested size, a roll of 2 meters or 4 meters width will be selected for cutting. The roll width of 2 meters is available up to 7,5 linear meters maximum. All orders that require an amount of linear meters above 7,5 meter will be cut from a roll of 4 meters width.

\* [Click here to see the overview of our edge finishing options and maximum rug sizes.](#)

PLEASE NOTE! Prices shown are public prices including VAT and do not include the shipping costs. This product is always rolled in the roll width direction to maintain its structural integrity. Please note that this can affect the transportation costs, depending on the size of the rug. [Click here to see the overview of shipping costs per country \(page 3\).](#)

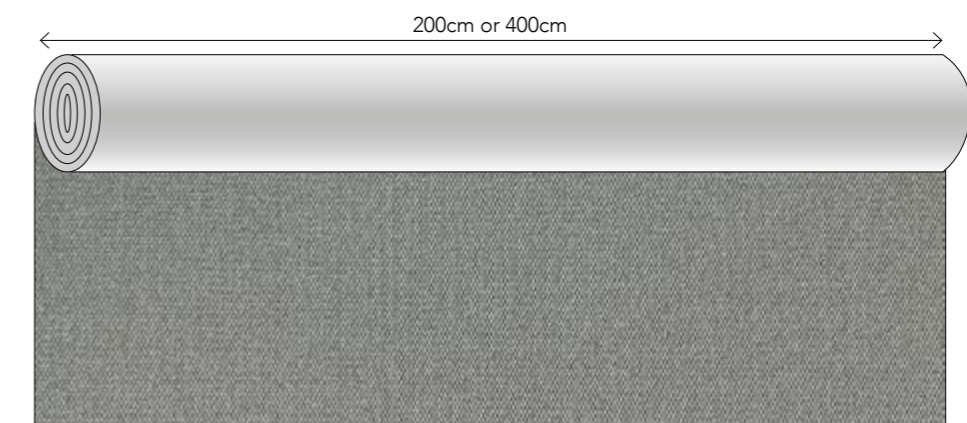

This pattern is not on scale, this image only shows the pattern direction



FRONT ROW

Available as Rug, wall-to-wall, (stair)runner  
 Pile surface Loop pile  
 Pile composition 100% P.P.  
 Size 4m width, up to 30m length  
 Shape Rectangular or circular  
 Carpet weight ± 1.650 g/m<sup>2</sup>  
 Carpet thickness ± 4 mm  
 Backing Gel backing  
 Roll width 4 meter  
 Fire classification Cfl-s1  
 Colors 8 standard  
 Advantages  
 + suitable for indoor and outdoor use  
 + suitable for residential and contract  
 + waterproof and UV proof  
 + easy cleaning  
 + castor proof

Note Rubber underlayment is highly recommended for all wall-to-wall installations and area rugs



FRONT ROW PRICE LIST

ARTICLE	ARTICLE CODE	COLOR	PRICE P/M <sup>2</sup> WITH OVERLOCK EDGE*	PRICE P/M <sup>2</sup> WITH PADDED FOLDED EDGE*
Rug	FRR8901	8901	€ 209,-	€ 333,-
	FRR8902	8902	€ 209,-	€ 333,-
	FRR8903	8903	€ 209,-	€ 333,-
	FRR8904	8904	€ 209,-	€ 333,-
	FRR8905	8905	€ 209,-	€ 333,-
	FRR8906	8906	€ 209,-	€ 333,-
	FRR8907	8907	€ 209,-	€ 333,-
	FRR8908	8908	€ 209,-	€ 333,-

Your rug will be cut from a roll of 4 meters width. Please include the cutting loss in your order. If you need any help calculating this, we are glad to be of service. Rectangle, square and round shapes are possible. For prices and special shapes please contact us.

\* Click here to see the overview of our edge finishing options and maximum rug sizes. Rugs with a folded padded edge will have felted padding at the bottom, therefore they can only be used indoors and can not be used for stair runners. Please calculate a 10 cm margin around all edges for a rug with folded padded edge. Max. rug width for this finish is 380 cm.

PLEASE NOTE! Prices shown are public prices including VAT. The price per m<sup>2</sup> does not include the shipping costs. Click here to see the overview of shipping costs per country (page 3).

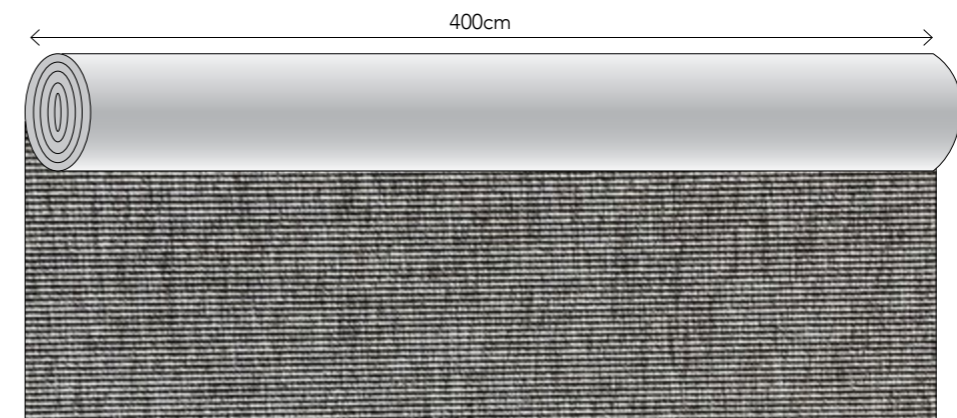

This pattern is not on scale, this image only shows the pattern direction



**GOOD LIFE**

Available as	Rug, wall-to-wall, (stair)runner
Pile surface	Loop pile
Pile composition	100% Recycled PET
Size	4m width, up to 32m length
Shape	Rectangular or circular
Carpet weight	± 2.300 g/m <sup>2</sup>
Carpet thickness	± 4 mm
Backing	P.P. + Latex
Roll width	2 or 4 meter
Fire classification	Dfl-s1
Colors	4 standard
Advantages	+ suitable for indoor and outdoor use + suitable for residential and contract + waterproof and UV proof + easy cleaning, even with diluted bleach + castor proof
Note	Rubber underlayment is highly recommended for all wall-to-wall installations and area rugs

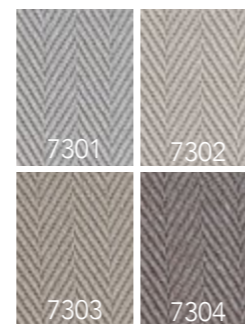

**GOOD LIFE PRICE LIST**

ARTICLE	ARTICLE CODE	COLOR	PRICE P/M <sup>2</sup> WITH OVERLOCK EDGE*	PRICE P/M <sup>2</sup> WITH BORDER*
Rug	GOL7301	7301	€ 235,-	€ 299,-
	GOL7302	7302	€ 235,-	€ 299,-
	GOL7303	7303	€ 235,-	€ 299,-
	GOL7304	7304	€ 235,-	€ 299,-

Your rug will be cut from a roll of 2 meters or 4 meters width. Please include the cutting loss in your order. If you need any help calculating this, we are glad to be of service. Rectangle, square and round shapes are possible. For prices and special shapes please contact us.

Depending on your requested size, a roll of 2 meters or 4 meters width will be selected for cutting. The roll width of 2 meters is available up to 7,5 linear meters maximum. All orders that require an amount of linear meters above 7,5 meter will be cut from a roll of 4 meters width.

\* [Click here to see the overview of our edge finishing options and maximum rug sizes.](#)

PLEASE NOTE! Prices shown are public prices including VAT and do not include the shipping costs. This product is always rolled in the roll width direction to maintain its structural integrity. Please note that this can affect the transportation costs, depending on the size of the rug. [Click here to see the overview of shipping costs per country \(page 3\).](#)

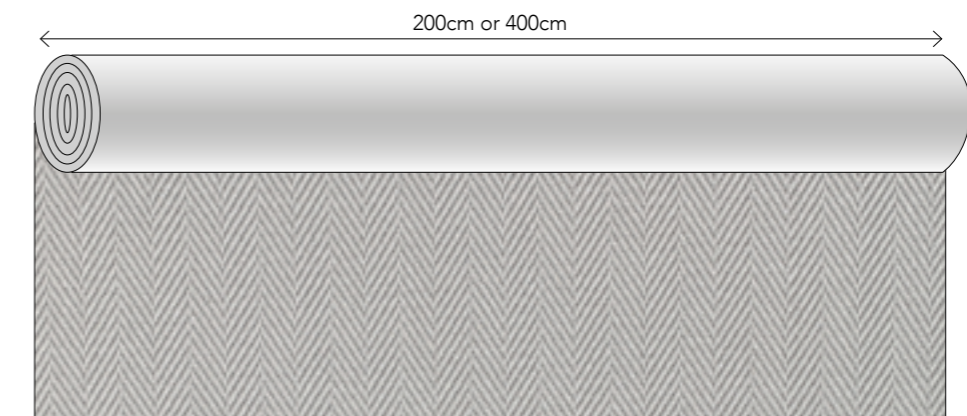

This pattern is not on scale, this image only shows the pattern direction



**HIGH TIDE**

- Available as Rug, wall-to-wall, (stair)runner
- Pile surface Loop pile
- Pile composition 100% Recycled PET
- Size Maximum 4m width, up to 32m length
- Shape Rectangular or circular
- Carpet weight ± 2.600 g/m<sup>2</sup>
- Carpet thickness ± 4 mm
- Backing P.P. + Latex
- Roll width 2 or 4 meter
- Fire classification Dfl-s1
- Colors 4 standard
- Advantages
  - + suitable for indoor and outdoor use
  - + suitable for residential and contract
  - + waterproof and UV proof
  - + easy cleaning, even with diluted bleach
  - + castor proof
- Note Rubber underlayment is highly recommended for all wall-to-wall installations and area rugs

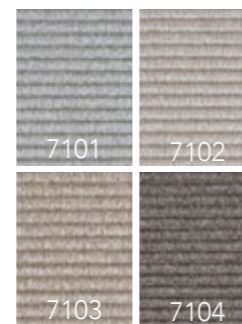

**HIGH TIDE PRICE LIST**

ARTICLE	ARTICLE CODE	COLOR	PRICE P/M <sup>2</sup> WITH OVERLOCK EDGE*	PRICE P/M <sup>2</sup> WITH BORDER*
Rug	HIT7101	7101	€ 235,-	€ 299,-
	HIT7102	7102	€ 235,-	€ 299,-
	HIT7103	7103	€ 235,-	€ 299,-
	HIT7104	7104	€ 235,-	€ 299,-

Your rug will be cut from a roll of 2 meters or 4 meters width. Please include the cutting loss in your order. If you need any help calculating this, we are glad to be of service. Rectangle, square and round shapes are possible. For prices and special shapes please contact us.

Depending on your requested size, a roll of 2 meters or 4 meters width will be selected for cutting. The roll width of 2 meters is available up to 7,5 linear meters maximum. All orders that require an amount of linear meters above 7,5 meter will be cut from a roll of 4 meters width.

\* [Click here to see the overview of our edge finishing options and maximum rug sizes.](#)

PLEASE NOTE! Prices shown are public prices including VAT and do not include the shipping costs. This product is always rolled in the roll width direction to maintain its structural integrity. Please note that this can affect the transportation costs, depending on the size of the rug. [Click here to see the overview of shipping costs per country \(page 3\).](#)

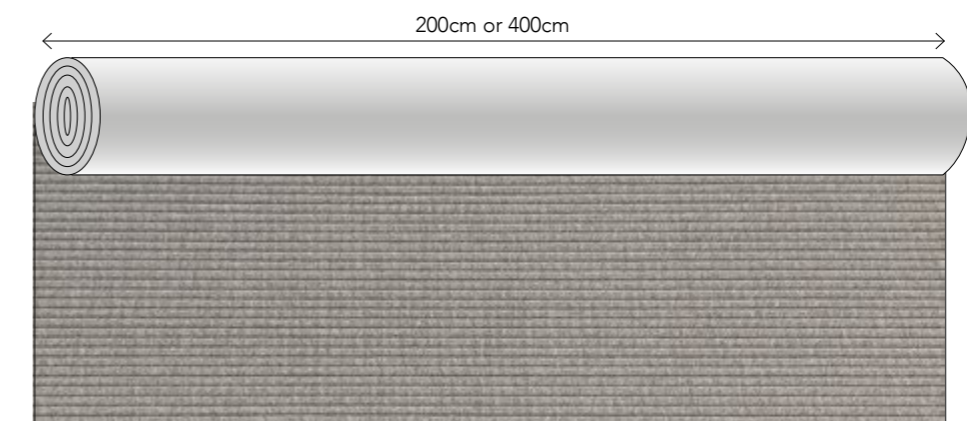

This pattern is not on scale, this image only shows the pattern direction



LAY OUT

Available as	Rug, runner
Pile surface	Loop pile
Pile composition	100% Wool
Size	Maximum 4m width, up to 32m length
Shape	Any shape possible
Carpet weight	± 2.700 g/m <sup>2</sup>
Carpet thickness	± 7 mm
Backing	Jute & cotton
Roll width	4 meters
Fire classification	Bfl-s1
Colors	4 standard colors
Advantages	+ suitable for heavy domestic use and soft contract + durable and hypoallergenic properties + natural backing with jute and cotton + custom shape possible
Note	Anti-slip underlayment is advised



LAY OUT PRICE LIST

ARTICLE	ARTICLE CODE	COLOR	PRICE P/M <sup>2</sup> WITH OVERLOCK EDGE*
Rug	LAO1601	1601	€ 335,-
	LAO1602	1602	€ 335,-
	LAO1603	1603	€ 335,-
	LAO1604	1604	€ 335,-

Your rug will be cut from a roll of 4 meters width. Please take cutting loss into account, in case the requested rug size is smaller than the width of the roll. If you need any help with calculations, we are glad to be of service. Rectangle, square, round and organic shapes are possible. For prices please contact us.

\* [Click here to see the overview of our edge finishing options and maximum rug sizes.](#)

PLEASE NOTE! Prices shown are public prices including VAT and do not include the shipping costs. [Click here to see the overview of shipping costs per country \(page 3\).](#) This product is always rolled in the roll width direction to maintain its structural integrity. Please note that this can affect the transportation costs, depending on the size of the rug.



This pattern is not on scale, this image only shows the pattern direction



LINE UP

Available as	Rug, runner
Pile surface	Loop pile
Pile composition	100% Wool
Size	Maximum 4m width, up to 32m length
Shape	Any shape possible
Carpet weight	± 2.700 g/m <sup>2</sup>
Carpet thickness	± 7 mm
Backing	Jute & cotton
Roll width	4 meters
Fire classification	Bfl-s1
Colors	4 standard colors
Advantages	+ suitable for heavy domestic use and soft contract + durable and hypoallergenic properties + natural backing with jute and cotton + custom shape possible
Note	Anti-slip underlayment is advised



LINE UP PRICE LIST

ARTICLE	ARTICLE CODE	COLOR	PRICE P/M <sup>2</sup> WITH OVERLOCK EDGE*
Rug	LIP1701	1701	€ 335,-
	LIP1702	1702	€ 335,-
	LIP1703	1703	€ 335,-
	LIP1704	1704	€ 335,-

Your rug will be cut from a roll of 4 meters width. Please take cutting loss into account, in case the requested rug size is smaller than the width of the roll. If you need any help with calculations, we are glad to be of service. Rectangle, square, round and organic shapes are possible. For prices please contact us.

\* [Click here to see the overview of our edge finishing options and maximum rug sizes.](#)

PLEASE NOTE! Prices shown are public prices including VAT and do not include the shipping costs. [Click here to see the overview of shipping costs per country \(page 3\).](#) This product is always rolled in the roll width direction to maintain its structural integrity. Please note that this can affect the transportation costs, depending on the size of the rug.

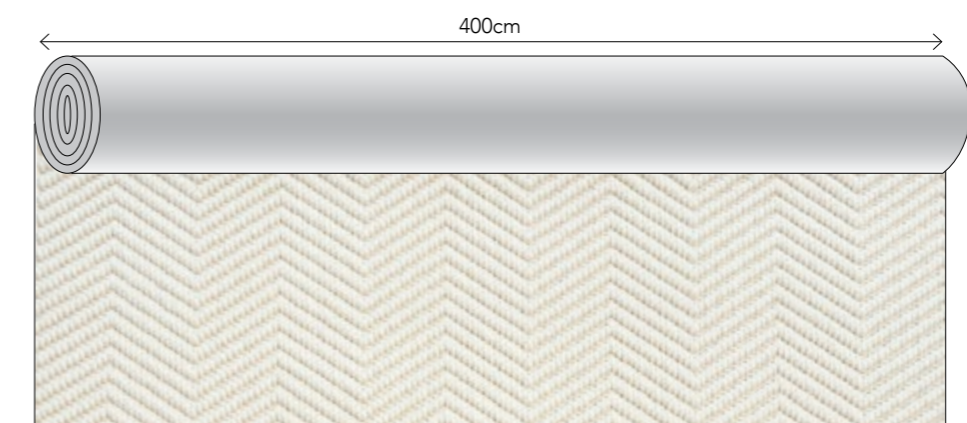

This pattern is not on scale, this image only shows the pattern direction



MILE STONE PRICE LIST

ARTICLE	ARTICLE CODE	COLOR	PRICE P/M <sup>2</sup>
Rug	MIS4901	4901	€ 775,-
	MIS4902	4902	€ 775,-
	MIS4903	4903	€ 775,-
	MIS4904	4904	€ 775,-
	MIS4905	4905	€ 775,-
	MIS4906	4906	€ 775,-

PLEASE NOTE! Prices shown are public prices including VAT. The price per m<sup>2</sup> does not include the shipping costs. Click here to see the overview of shipping costs per country (page 3).

MILE STONE

Available as Rug, runner  
 Design Frankly Amsterdam  
 Size Maximum width 5 meter, infinite length  
 Technique Handwoven  
 Colors 6 Standard + 161 uni  
 Color design Christiane Müller  
 Material 50% Eucalyptus, 50% Virgin Wool  
 Endings Plain ending: Blind ending:



Fire classification Eucalyptus Cfl-s1, Virgin Wool Bfl-s1  
 Advantages + European production  
 + any size possible  
 + maximum width 5 meters  
 + 110 Wool- and 51 Eucalyptus colors to choose from  
 + suitable for residential as well as soft contract





**NEXT STEP**

Available as	Rug, wall-to-wall, (stair)runner
Pile surface	Loop pile
Pile composition	100% P.P.
Size	4m width, up to 30m length
Shape	Rectangular or circular
Carpet weight	± 1.900 g/m <sup>2</sup>
Carpet thickness	± 5 mm
Backing	Gel backing
Roll width	4 meter
Fire classification	Cfl-s1
Colors	5 standard
Advantages	+ suitable for indoor and outdoor use + suitable for residential and contract + waterproof and UV proof + easy cleaning + castor proof
Note	Rubber underlayment is highly recommended for all wall-to-wall installations and area rugs



**NEXT STEP PRICE LIST**

ARTICLE	ARTICLE CODE	COLOR	PRICE P/M <sup>2</sup> WITH OVERLOCK EDGE*	PRICE P/M <sup>2</sup> WITH PADDED FOLDED EDGE*
Rug	NES9101	9101	€ 222,-	€ 339,-
	NES9102	9102	€ 222,-	€ 339,-
	NES9103	9103	€ 222,-	€ 339,-
	NES9104	9104	€ 222,-	€ 339,-
	NES9105	9105	€ 222,-	€ 339,-

Your rug will be cut from a roll of 4 meters width. Please include the cutting loss in your order. If you need any help calculating this, we are glad to be of service. Rectangle, square and round shapes are possible. For prices and special shapes please contact us.

\* [Click here to see the overview of our edge finishing options and maximum rug sizes.](#) Rugs with a folded padded edge will have felted padding at the bottom, therefore they can only be used indoors and can not be used for stair runners. Please calculate a 10 cm margin around all edges for a rug with folded padded edge. Max. rug width for this finish is 380 cm.

PLEASE NOTE! Prices shown are public prices including VAT. The price per m<sup>2</sup> does not include the shipping costs. [Click here to see the overview of shipping costs per country \(page 3\).](#)

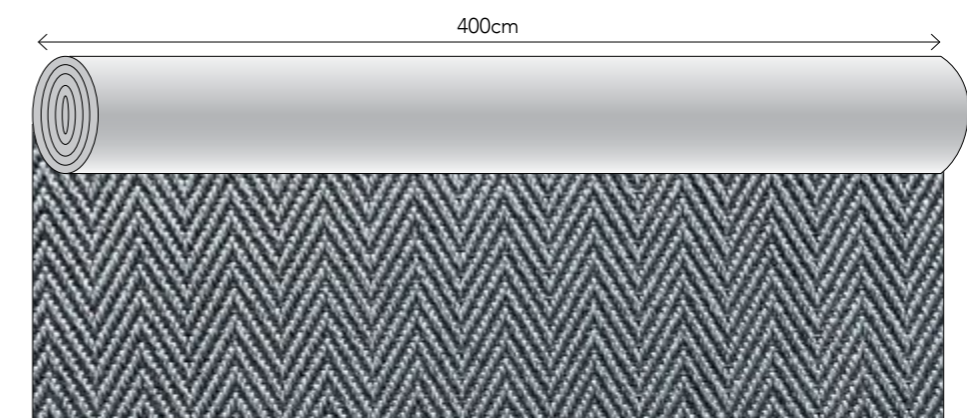

This pattern is not on scale, this image only shows the pattern direction



**NO DOUBT**

Available as Rug, wall-to-wall, (stair)runner  
 Pile surface Loop pile  
 Pile composition 100% P.P.  
 Size 4m width, up to 30m length  
 Shape Rectangular or circular  
 Carpet weight ± 1.950 g/m<sup>2</sup>  
 Carpet thickness ± 5 mm  
 Backing Gel backing  
 Roll width 4 meter  
 Fire classification Dfl-s1  
 Colors 5 standard  
 Advantages  
 + suitable for indoor and outdoor use  
 + suitable for residential and contract  
 + waterproof and UV proof  
 + easy cleaning  
 + castor proof

Note Rubber underlayment is highly recommended for all wall-to-wall installations and area rugs



**NO DOUBT PRICE LIST**

ARTICLE	ARTICLE CODE	COLOR	PRICE P/M <sup>2</sup> WITH OVERLOCK EDGE*	PRICE P/M <sup>2</sup> WITH PADDED FOLDED EDGE*
Rug	NOD9101	9001	€ 222,-	€ 339,-
	NOD9002	9002	€ 222,-	€ 339,-
	NOD9003	9003	€ 222,-	€ 339,-
	NOD9004	9004	€ 222,-	€ 339,-
	NOD9005	9005	€ 222,-	€ 339,-

Your rug will be cut from a roll of 4 meters width. Please include the cutting loss in your order. If you need any help calculating this, we are glad to be of service. Rectangle, square and round shapes are possible. For prices and special shapes please contact us.

\* [Click here to see the overview of our edge finishing options and maximum rug sizes.](#)  
 Rugs with a folded padded edge will have felted padding at the bottom, therefore they can only be used indoors and can not be used for stair runners. Please calculate a 10 cm margin around all edges for a rug with folded padded edge. Max. rug width for this finish is 380 cm.

PLEASE NOTE! Prices shown are public prices including VAT. The price per m<sup>2</sup> does not include the shipping costs. [Click here to see the overview of shipping costs per country \(page 3\).](#)

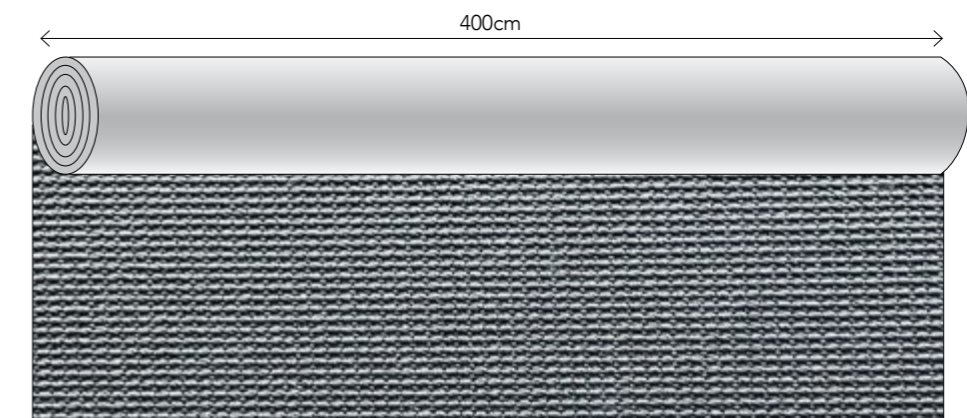

This pattern is not on scale, this image only shows the pattern direction



OUT LINE

Available as	Rug, runner
Pile surface	Loop pile
Pile composition	100% Wool
Size	4m width, up to 32m length
Shape	Any shape possible
Carpet weight	± 2.700 g/m <sup>2</sup>
Carpet thickness	± 7 mm
Backing	Jute & cotton
Roll width	4 meters
Fire classification	Bfl-s1
Colors	4 standard colors
Advantages	+ suitable for heavy domestic use and soft contract + durable and hypoallergenic properties + natural backing with jute and cotton + custom shape possible
Note	Anti-slip underlayment is advised



OUT LINE PRICE LIST

ARTICLE	ARTICLE CODE	COLOR	PRICE P/M <sup>2</sup> WITH OVERLOCK EDGE*
Rug	OUL1801	1801	€ 335,-
	OUL1802	1802	€ 335,-
	OUL1803	1803	€ 335,-
	OUL1804	1804	€ 335,-

Your rug will be cut from a roll of 4 meters width. Please take cutting loss into account, in case the requested rug size is smaller than the width of the roll. If you need any help with calculations, we are glad to be of service. Rectangle, square, round and organic shapes are possible. For prices please contact us.

\* [Click here to see the overview of our edge finishing options and maximum rug sizes.](#)

PLEASE NOTE! Prices shown are public prices including VAT and do not include the shipping costs. [Click here to see the overview of shipping costs per country \(page 3\).](#) This product is always rolled in the roll width direction to maintain its structural integrity. Please note that this can affect the transportation costs, depending on the size of the rug.



This pattern is not on scale, this image only shows the pattern direction



**ROLL OVER**

Available as Rug, wall-to-wall, (stair)runner  
 Pile surface Loop Pile  
 Pile composition 100% Wool  
 Size Maximum 4m width, up to 32m length  
 Shape Rectangular or circular  
 Pile weight ± 1.060 g/m<sup>2</sup>  
 Carpet weight ± 2.000 g/m<sup>2</sup>  
 Pile height ± 3,0 mm  
 Carpet thickness ± 4,0 mm  
 Backing P.P. & Latex  
 Roll width 2 or 4 meter  
 Fire classification Bfl-s1  
 Colors 6 standard  
 Advantages + suitable for residential as well as contract  
 + long-lasting & fire retardant  
 + castor proof  
 + VOC-emission label A+  
 Note Rubber underlayment is highly recommended for all wall-to-wall installations and area rugs

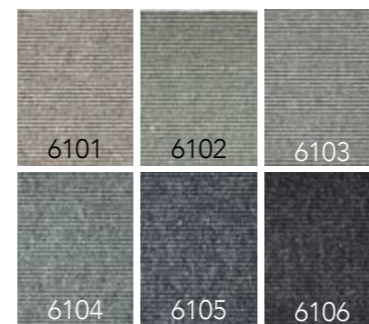

**ROLL OVER PRICE LIST**

ARTICLE	ARTICLE CODE	COLOR	PRICE P/M <sup>2</sup> WITH OVERLOCK EDGE*
Rug	ROO6101	6101	€ 215,-
	ROO6102	6102	€ 215,-
	ROO6103	6103	€ 215,-
	ROO6104	6104	€ 215,-
	ROO6105	6105	€ 215,-
	ROO6106	6106	€ 215,-

Your rug will be cut from a roll of 2 meters or 4 meters width. Please include the cutting loss in your order. If you need any help calculating this, we are glad to be of service. Rectangle, square and round shapes are possible. For prices and special shapes please contact us.

Depending on your requested size, a roll of 2 meters or 4 meters width will be selected for cutting. The roll width of 2 meters is available up to 7,5 linear meters maximum. All orders that require an amount of linear meters above 7,5 meter will be cut from a roll of 4 meters width.

\* [Click here to see the overview of our edge finishing options and maximum rug sizes.](#)

PLEASE NOTE! Prices shown are public prices including VAT. The price per m<sup>2</sup> does not include the shipping costs. [Click here to see the overview of shipping costs per country \(page 3\).](#)

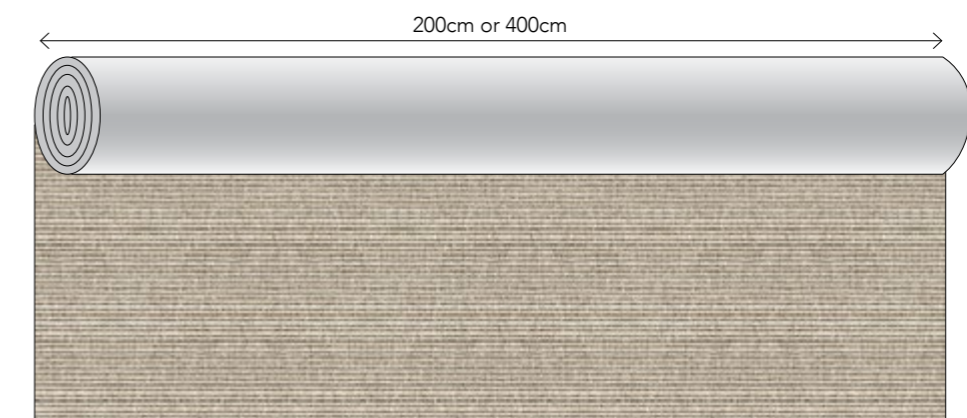

This pattern is not on scale, this image only shows the pattern direction

FRANKLY  
AMSTERDAM

OUTDOOR RUGS



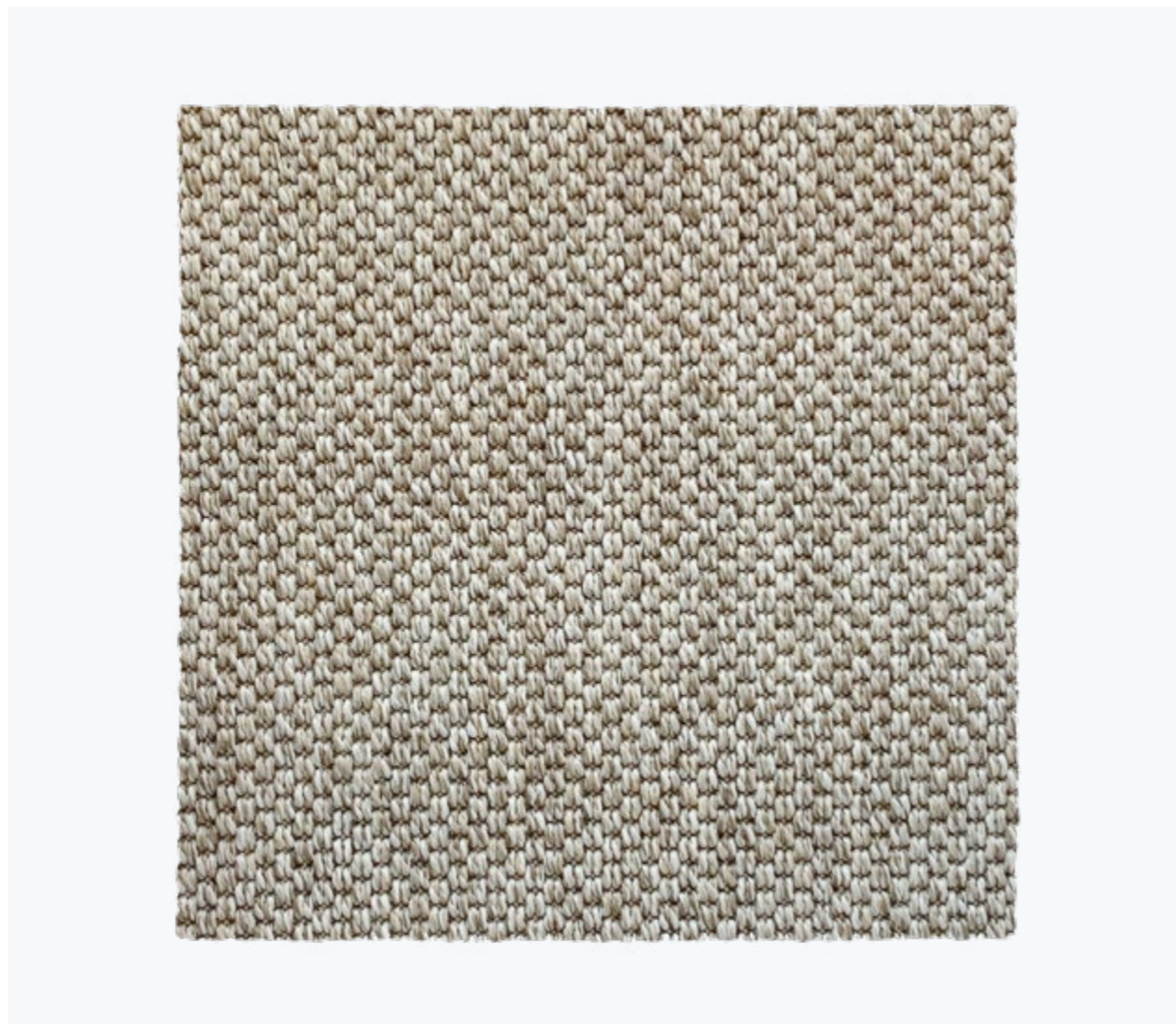

**ALL STAR**

Available as Rug, wall-to-wall, (stair)runner  
 Pile surface Loop pile  
 Pile composition 100% P.P.  
 Size 4m width, up to 30m length  
 Shape Rectangular or circular  
 Carpet weight ± 1.650 g/m<sup>2</sup>  
 Carpet thickness ± 5 mm  
 Backing Gel backing. Color 8801 and 8808 have a Precoat Latex backing  
 Roll width 4 meter  
 Fire classification Cfl-s1 / Efl for color 8801 and 8808  
 Colors 11 standard  
 Advantages + suitable for indoor and outdoor use  
 + suitable for residential and contract  
 + waterproof, UV proof and easy cleaning  
 + castor proof  
 Note Rubber underlayment is highly recommended for all wall-to-wall installations and area rugs



**ALL STAR PRICE LIST**

ARTICLE	ARTICLE CODE	COLOR	PRICE P/M <sup>2</sup> WITH OVERLOCK EDGE*	PRICE P/M <sup>2</sup> WITH PADDED FOLDED EDGE*
Rug	ALS8801	8801	€ 209,-	€ 333,-
	ALS8802	8802	€ 209,-	€ 333,-
	ALS8803	8803	€ 209,-	€ 333,-
	ALS8804	8804	€ 209,-	€ 333,-
	ALS8805	8805	€ 209,-	€ 333,-
	ALS8806	8806	€ 209,-	€ 333,-
	ALS8807	8807	€ 209,-	€ 333,-
	ALS8808	8808	€ 209,-	€ 333,-
	ALS8809	8809	€ 209,-	€ 333,-
	ALS8810	8810	€ 209,-	€ 333,-
	ALS8811	8811	€ 209,-	€ 333,-

Your rug will be cut from a roll of 4 meters width. Please include the cutting loss in your order. If you need any help calculating this, we are glad to be of service. Rectangle, square and round shapes are possible. For prices and special shapes please contact us.

\* **Click here to see the overview of our edge finishing options and maximum rug sizes.** Rugs with a folded padded edge will have felted padding at the bottom, therefore they can only be used indoors and can not be used for stair runners. Please calculate a 10 cm margin around all edges for a rug with folded padded edge. Max. rug width for this finish is 380 cm.

PLEASE NOTE! Prices shown are public prices including VAT. The price per m<sup>2</sup> does not include the shipping costs. Click here to see the overview of shipping costs per country (page 3).

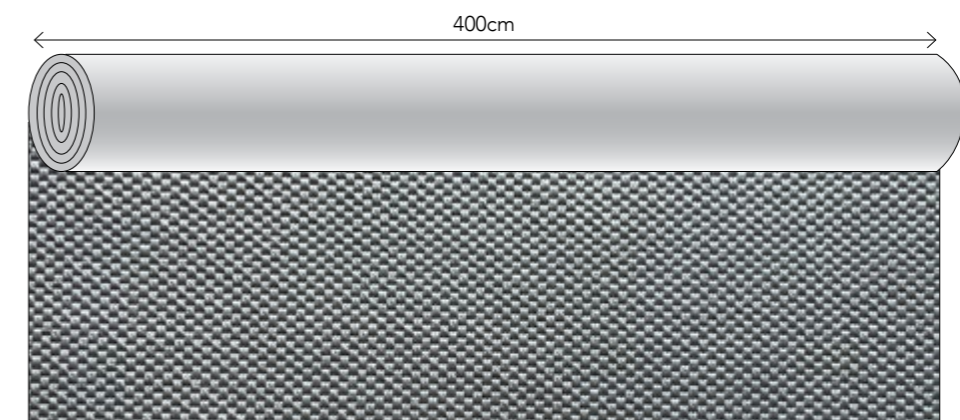

This pattern is not on scale, this image only shows the pattern direction

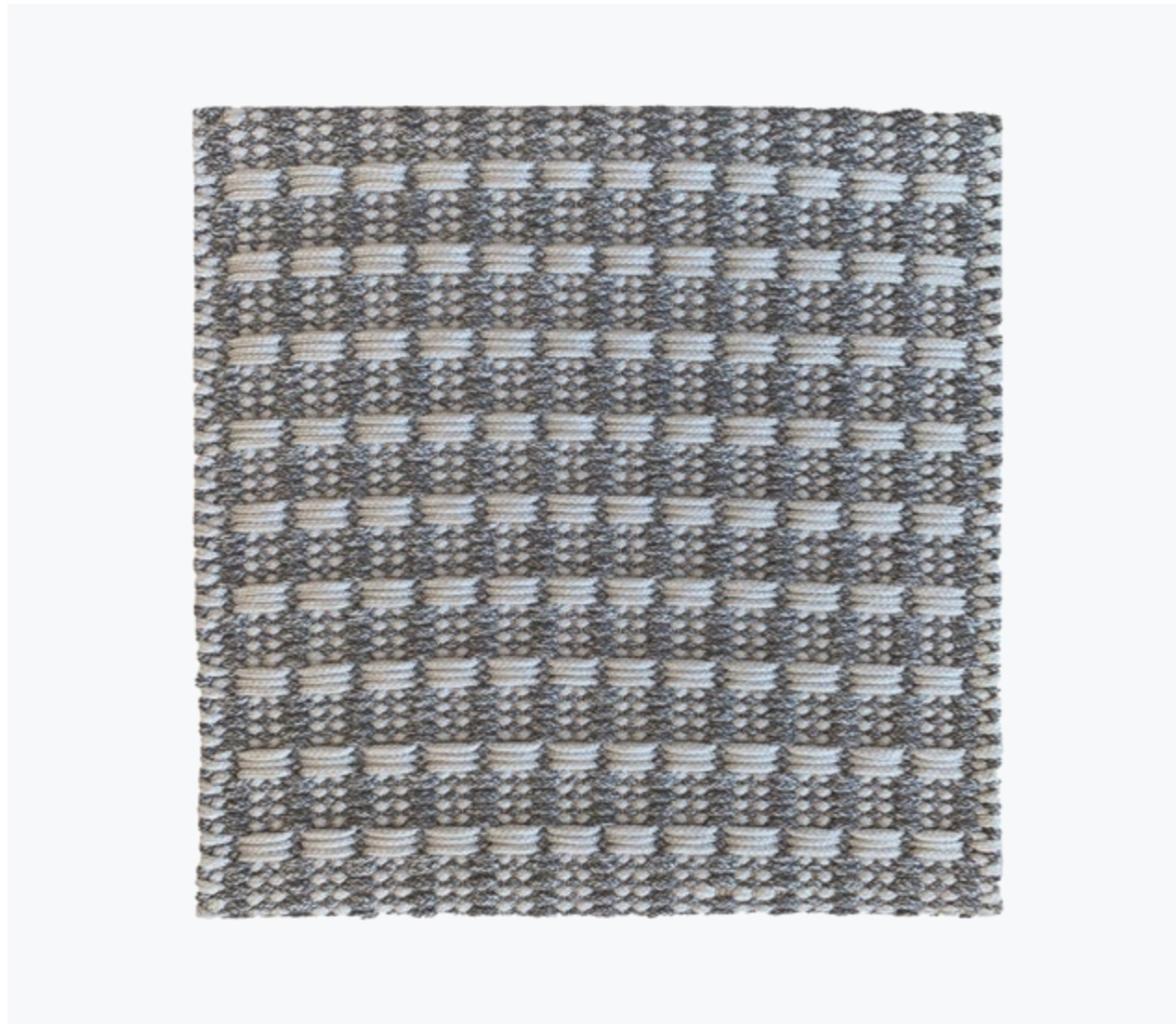

BOTTOM LINE OUTDOOR PRICE LIST

ARTICLE	ARTICLE CODE	COLOR	PRICE P/M <sup>2</sup>
Rug	BOL6601	6601	€ 939,-
	BOL6602	6602	€ 939,-
	BOL6603	6603	€ 939,-
	BOL6604	6604	€ 939,-
	BOL6605	6605	€ 939,-

PLEASE NOTE! Prices shown are public prices including VAT. The price per m<sup>2</sup> does not include the shipping costs. Click here to see the overview of shipping costs per country (page 3).

BOTTOM LINE OUTDOOR

Available as Rug, outdoor rug  
 Design Frankly Amsterdam  
 Size Maximum width 5 meter, infinite length  
 Technique Handwoven  
 Colors 6 Standard, 25 uni for custom colormix  
 Color design Frankly Amsterdam  
 Material 100% Polypropylene  
 Endings Blind ending (as photo above)  
 Advantages + suitable for outdoor use  
 + European production  
 + maximum width 5 meters  
 + suitable for residential as well as soft contract

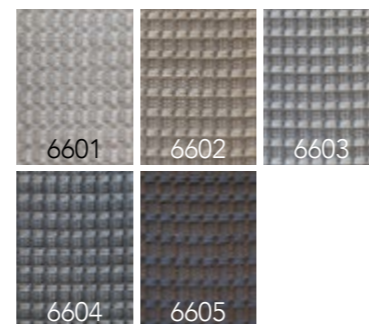

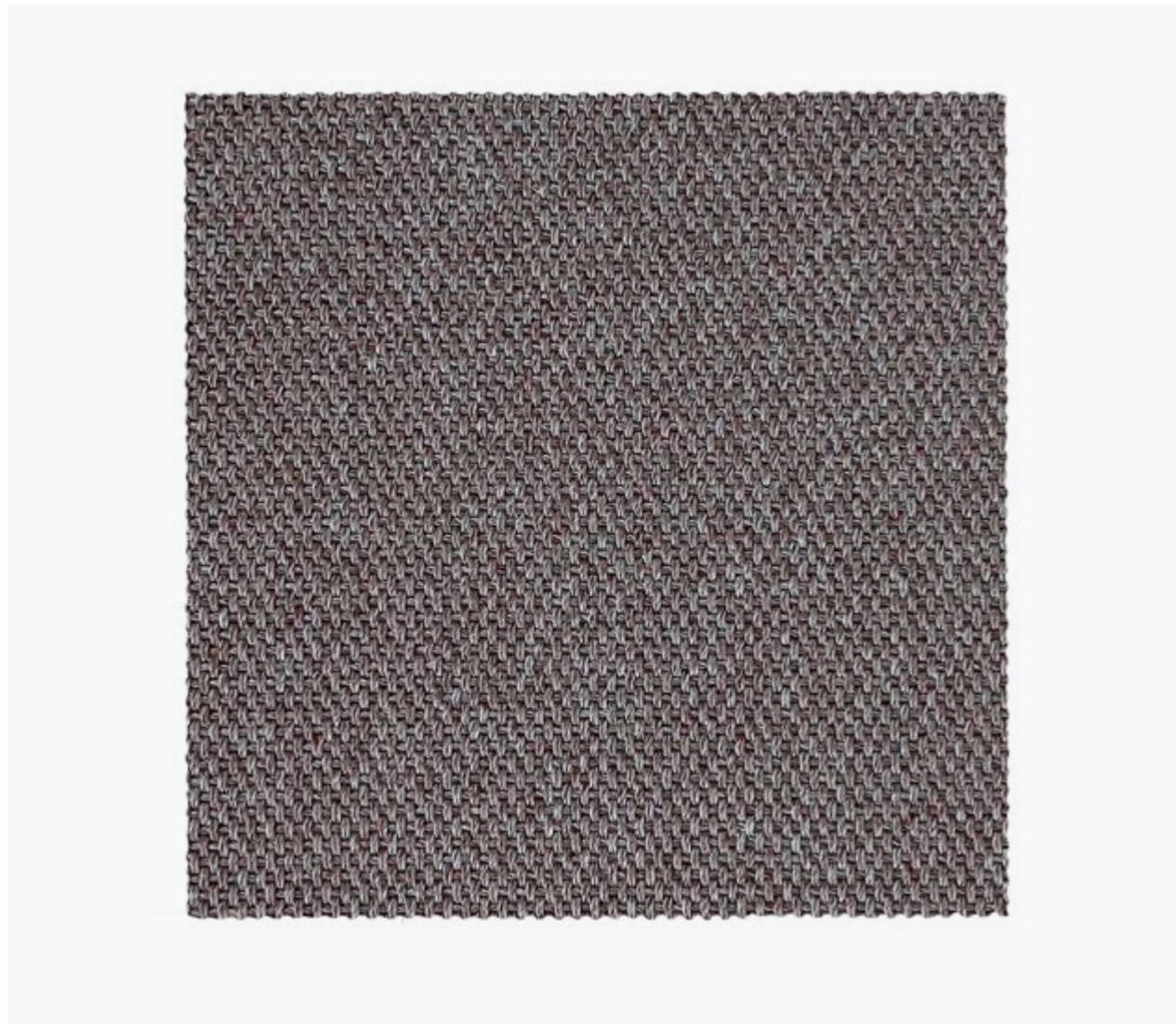

**EASY GOING**

Available as Rug, wall-to-wall, (stair)runner  
 Pile surface Loop pile  
 Pile composition 100% Recycled PET  
 Size Maximum 4m width, up to 32m length  
 Shape Rectangular or circular  
 Carpet weight ± 2.400 g/m<sup>2</sup>  
 Carpet thickness ± 4 mm  
 Backing P.P. + Latex  
 Roll width 2 or 4 meter  
 Fire classification Dfl-s1  
 Colors 6 standard  
 Advantages  
 + suitable for indoor and outdoor use  
 + suitable for residential and contract  
 + waterproof and UV proof  
 + easy cleaning, even with diluted bleach  
 + castor proof

Note Rubber underlayment is highly recommended for all wall-to-wall installations and area rugs



**EASY GOING PRICE LIST**

ARTICLE	ARTICLE CODE	COLOR	PRICE P/M <sup>2</sup> WITH OVERLOCK EDGE*	PRICE P/M <sup>2</sup> WITH BORDER*
Rug	EAG7401	7401	€ 235,-	€ 299,-
	EAG7402	7402	€ 235,-	€ 299,-
	EAG7403	7403	€ 235,-	€ 299,-
	EAG7404	7404	€ 235,-	€ 299,-
	EAG7405	7405	€ 235,-	€ 299,-
	EAG7406	7406	€ 235,-	€ 299,-

Your rug will be cut from a roll of 2 meters or 4 meters width. Please include the cutting loss in your order. If you need any help calculating this, we are glad to be of service. Rectangle, square and round shapes are possible. For prices and special shapes please contact us.

Depending on your requested size, a roll of 2 meters or 4 meters width will be selected for cutting. The roll width of 2 meters is available up to 7,5 linear meters maximum. All orders that require an amount of linear meters above 7,5 meter will be cut from a roll of 4 meters width.

\* [Click here to see the overview of our edge finishing options and maximum rug sizes.](#)

PLEASE NOTE! Prices shown are public prices including VAT and do not include the shipping costs. This product is always rolled in the roll width direction to maintain its structural integrity. Please note that this can affect the transportation costs, depending on the size of the rug. [Click here to see the overview of shipping costs per country \(page 3\).](#)

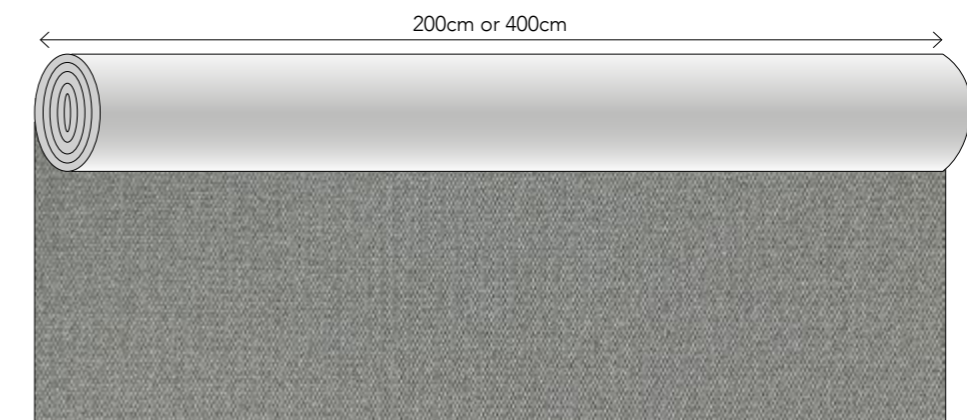

This pattern is not on scale, this image only shows the pattern direction





FRONT ROW

Available as Rug, wall-to-wall, (stair)runner  
 Pile surface Loop pile  
 Pile composition 100% P.P.  
 Size 4m width, up to 30m length  
 Shape Rectangular or circular  
 Carpet weight ± 1.650 g/m<sup>2</sup>  
 Carpet thickness ± 4 mm  
 Backing Gel backing  
 Roll width 4 meter  
 Fire classification Cfl-s1  
 Colors 8 standard  
 Advantages  
 + suitable for indoor and outdoor use  
 + suitable for residential and contract  
 + waterproof and UV proof  
 + easy cleaning  
 + castor proof



Note Rubber underlayment is highly recommended for all wall-to-wall installations and area rugs

FRONT ROW PRICE LIST

ARTICLE	ARTICLE CODE	COLOR	PRICE P/M <sup>2</sup> WITH OVERLOCK EDGE*	PRICE P/M <sup>2</sup> WITH PADDED FOLDED EDGE*
Rug	FRR8901	8901	€ 209,-	€ 333,-
	FRR8902	8902	€ 209,-	€ 333,-
	FRR8903	8903	€ 209,-	€ 333,-
	FRR8904	8904	€ 209,-	€ 333,-
	FRR8905	8905	€ 209,-	€ 333,-
	FRR8906	8906	€ 209,-	€ 333,-
	FRR8907	8907	€ 209,-	€ 333,-
	FRR8908	8908	€ 209,-	€ 333,-

Your rug will be cut from a roll of 4 meters width. Please include the cutting loss in your order. If you need any help calculating this, we are glad to be of service. Rectangle, square and round shapes are possible. For prices and special shapes please contact us.

\* Click here to see the overview of our edge finishing options and maximum rug sizes. Rugs with a folded padded edge will have felted padding at the bottom, therefore they can only be used indoors and can not be used for stair runners. Please calculate a 10 cm margin around all edges for a rug with folded padded edge. Max. rug width for this finish is 380 cm.

PLEASE NOTE! Prices shown are public prices including VAT. The price per m<sup>2</sup> does not include the shipping costs. Click here to see the overview of shipping costs per country (page 3).

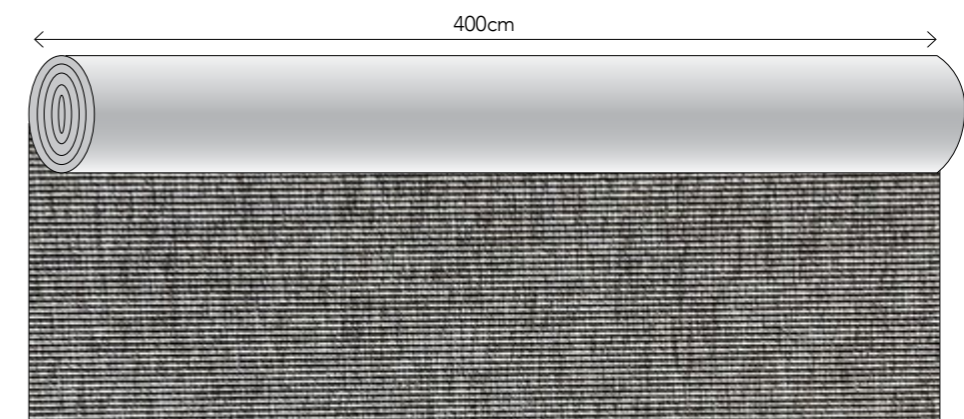

This pattern is not on scale, this image only shows the pattern direction



**GOOD LIFE**

Available as	Rug, wall-to-wall, (stair)runner
Pile surface	Loop pile
Pile composition	100% Recycled PET
Size	4m width, up to 32m length
Shape	Rectangular or circular
Carpet weight	± 2.300 g/m <sup>2</sup>
Carpet thickness	± 4 mm
Backing	P.P. + Latex
Roll width	2 or 4 meter
Fire classification	Dfl-s1
Colors	4 standard
Advantages	+ suitable for indoor and outdoor use + suitable for residential and contract + waterproof and UV proof + easy cleaning, even with diluted bleach + castor proof
Note	Rubber underlayment is highly recommended for all wall-to-wall installations and area rugs

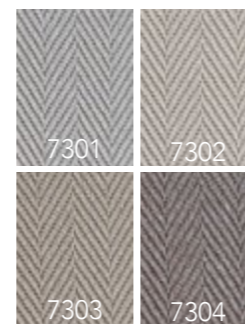

**GOOD LIFE PRICE LIST**

ARTICLE	ARTICLE CODE	COLOR	PRICE P/M <sup>2</sup> WITH OVERLOCK EDGE*	PRICE P/M <sup>2</sup> WITH BORDER*
Rug	GOL7301	7301	€ 235,-	€ 299,-
	GOL7302	7302	€ 235,-	€ 299,-
	GOL7303	7303	€ 235,-	€ 299,-
	GOL7304	7304	€ 235,-	€ 299,-

Your rug will be cut from a roll of 2 meters or 4 meters width. Please include the cutting loss in your order. If you need any help calculating this, we are glad to be of service. Rectangle, square and round shapes are possible. For prices and special shapes please contact us.

Depending on your requested size, a roll of 2 meters or 4 meters width will be selected for cutting. The roll width of 2 meters is available up to 7,5 linear meters maximum. All orders that require an amount of linear meters above 7,5 meter will be cut from a roll of 4 meters width.

\* [Click here to see the overview of our edge finishing options and maximum rug sizes.](#)

PLEASE NOTE! Prices shown are public prices including VAT and do not include the shipping costs. This product is always rolled in the roll width direction to maintain its structural integrity. Please note that this can affect the transportation costs, depending on the size of the rug. [Click here to see the overview of shipping costs per country \(page 3\).](#)

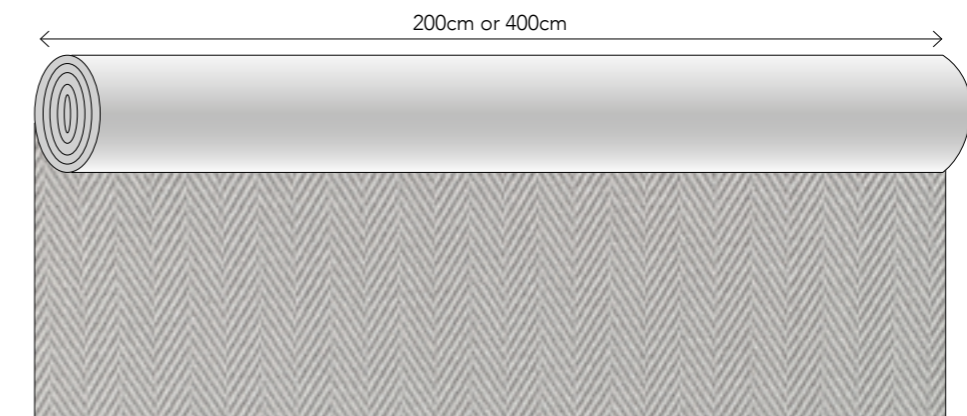

This pattern is not on scale, this image only shows the pattern direction



**HIGH TIDE**

Available as	Rug, wall-to-wall, (stair)runner
Pile surface	Loop pile
Pile composition	100% Recycled PET
Size	Maximum 4m width, up to 32m length
Shape	Rectangular or circular
Carpet weight	± 2.600 g/m <sup>2</sup>
Carpet thickness	± 4 mm
Backing	P.P. + Latex
Roll width	2 or 4 meter
Fire classification	Dfl-s1
Colors	4 standard
Advantages	+ suitable for indoor and outdoor use + suitable for residential and contract + waterproof and UV proof + easy cleaning, even with diluted bleach + castor proof
Note	Rubber underlayment is highly recommended for all wall-to-wall installations and area rugs

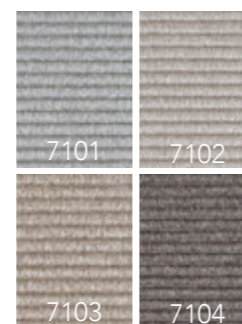

**HIGH TIDE PRICE LIST**

ARTICLE	ARTICLE CODE	COLOR	PRICE P/M <sup>2</sup> WITH OVERLOCK EDGE*	PRICE P/M <sup>2</sup> WITH BORDER*
Rug	HIT7101	7101	€ 235,-	€ 299,-
	HIT7102	7102	€ 235,-	€ 299,-
	HIT7103	7103	€ 235,-	€ 299,-
	HIT7104	7104	€ 235,-	€ 299,-

Your rug will be cut from a roll of 2 meters or 4 meters width. Please include the cutting loss in your order. If you need any help calculating this, we are glad to be of service. Rectangle, square and round shapes are possible. For prices and special shapes please contact us.

Depending on your requested size, a roll of 2 meters or 4 meters width will be selected for cutting. The roll width of 2 meters is available up to 7,5 linear meters maximum. All orders that require an amount of linear meters above 7,5 meter will be cut from a roll of 4 meters width.

\* [Click here to see the overview of our edge finishing options and maximum rug sizes.](#)

PLEASE NOTE! Prices shown are public prices including VAT and do not include the shipping costs. This product is always rolled in the roll width direction to maintain its structural integrity. Please note that this can affect the transportation costs, depending on the size of the rug. [Click here to see the overview of shipping costs per country \(page 3\).](#)

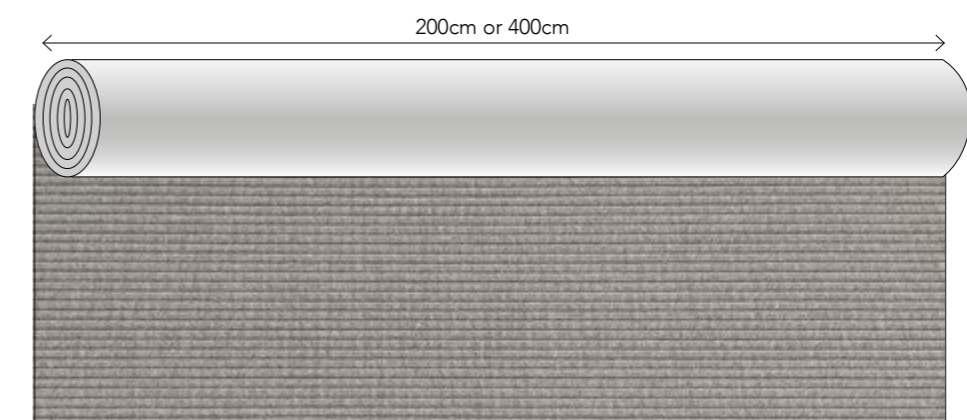

This pattern is not on scale, this image only shows the pattern direction



**NEXT STEP**

Available as Rug, wall-to-wall, (stair)runner  
 Pile surface Loop pile  
 Pile composition 100% P.P.  
 Size 4m width, up to 30m length  
 Shape Rectangular or circular  
 Carpet weight ± 1.900 g/m<sup>2</sup>  
 Carpet thickness ± 5 mm  
 Backing Gel backing  
 Roll width 4 meter  
 Fire classification Cfl-s1  
 Colors 5 standard  
 Advantages  
 + suitable for indoor and outdoor use  
 + suitable for residential and contract  
 + waterproof and UV proof  
 + easy cleaning  
 + castor proof

Note Rubber underlayment is highly recommended for all wall-to-wall installations and area rugs

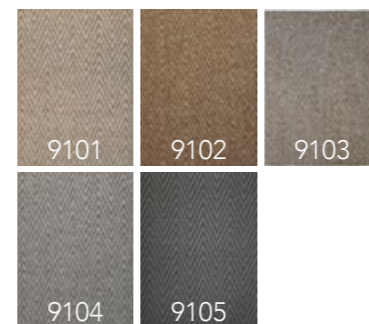

**NEXT STEP PRICE LIST**

ARTICLE	ARTICLE CODE	COLOR	PRICE P/M <sup>2</sup> WITH OVERLOCK EDGE*	PRICE P/M <sup>2</sup> WITH PADDED FOLDED EDGE*
Rug	NES9101	9101	€ 222,-	€ 339,-
	NES9102	9102	€ 222,-	€ 339,-
	NES9103	9103	€ 222,-	€ 339,-
	NES9104	9104	€ 222,-	€ 339,-
	NES9105	9105	€ 222,-	€ 339,-

Your rug will be cut from a roll of 4 meters width. Please include the cutting loss in your order. If you need any help calculating this, we are glad to be of service. Rectangle, square and round shapes are possible. For prices and special shapes please contact us.

\* [Click here to see the overview of our edge finishing options and maximum rug sizes.](#)  
 Rugs with a folded padded edge will have felted padding at the bottom, therefore they can only be used indoors and can not be used for stair runners. Please calculate a 10 cm margin around all edges for a rug with folded padded edge. Max. rug width for this finish is 380 cm.

PLEASE NOTE! Prices shown are public prices including VAT. The price per m<sup>2</sup> does not include the shipping costs. [Click here to see the overview of shipping costs per country \(page 3\).](#)

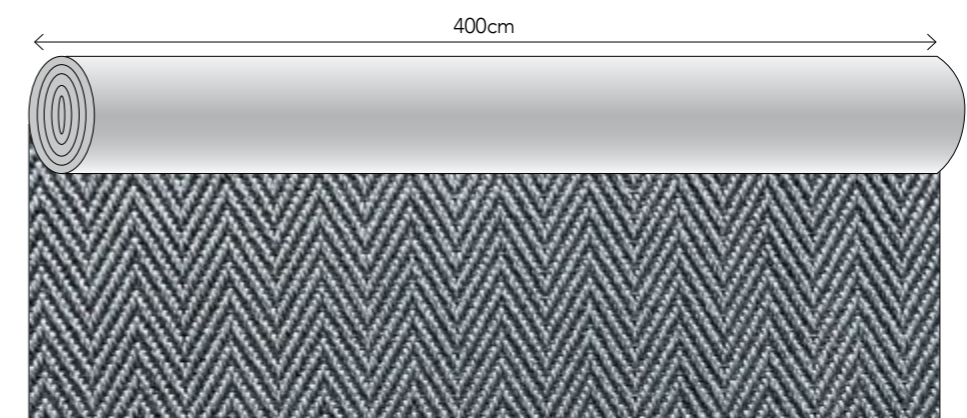

This pattern is not on scale, this image only shows the pattern direction



**NO DOUBT**

Available as Rug, wall-to-wall, (stair)runner  
 Pile surface Loop pile  
 Pile composition 100% P.P.  
 Size 4m width, up to 30m length  
 Shape Rectangular or circular  
 Carpet weight ± 1.950 g/m<sup>2</sup>  
 Carpet thickness ± 5 mm  
 Backing Gel backing  
 Roll width 4 meter  
 Fire classification Dfl-s1  
 Colors 5 standard  
 Advantages  
 + suitable for indoor and outdoor use  
 + suitable for residential and contract  
 + waterproof and UV proof  
 + easy cleaning  
 + castor proof

Note Rubber underlayment is highly recommended for all wall-to-wall installations and area rugs



**NO DOUBT PRICE LIST**

ARTICLE	ARTICLE CODE	COLOR	PRICE P/M <sup>2</sup> WITH OVERLOCK EDGE*	PRICE P/M <sup>2</sup> WITH PADDED FOLDED EDGE*
Rug	NOD9101	9001	€ 222,-	€ 339,-
	NOD9002	9002	€ 222,-	€ 339,-
	NOD9003	9003	€ 222,-	€ 339,-
	NOD9004	9004	€ 222,-	€ 339,-
	NOD9005	9005	€ 222,-	€ 339,-

Your rug will be cut from a roll of 4 meters width. Please include the cutting loss in your order. If you need any help calculating this, we are glad to be of service. Rectangle, square and round shapes are possible. For prices and special shapes please contact us.

\* Click here to see the overview of our edge finishing options and maximum rug sizes. Rugs with a folded padded edge will have felted padding at the bottom, therefore they can only be used indoors and can not be used for stair runners. Please calculate a 10 cm margin around all edges for a rug with folded padded edge. Max. rug width for this finish is 380 cm.

PLEASE NOTE! Prices shown are public prices including VAT. The price per m<sup>2</sup> does not include the shipping costs. Click here to see the overview of shipping costs per country (page 3).

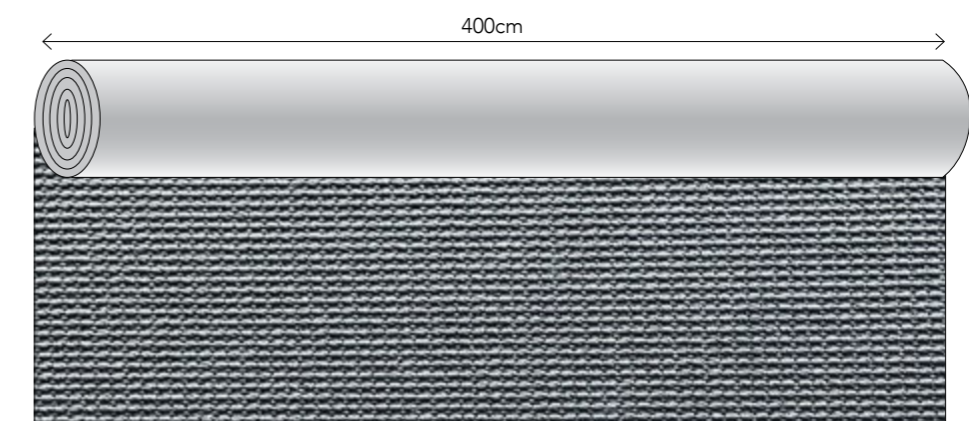

This pattern is not on scale, this image only shows the pattern direction



OFF SHORE PRICE LIST

ARTICLE	ARTICLE CODE	COLOR	PRICE P/M <sup>2</sup>
Rug	OFS5401	5401	€ 949,-
	OFS5402	5402	€ 949,-
	OFS5403	5403	€ 949,-
	OFS5404	5404	€ 949,-
	OFS5405	5405	€ 949,-
	OFS5406	5406	€ 949,-

PLEASE NOTE! Prices shown are public prices including VAT. The price per m<sup>2</sup> does not include the shipping costs. Click here to see the overview of shipping costs per country (page 3).

OFF SHORE

Available as  
Design  
Size  
Technique  
Colors  
Color design  
Material  
Endings  
Advantages

Rug, outdoor rug  
Frankly Amsterdam  
Maximum width 5 meter, infinite length  
Handwoven  
6 standard, 19 uni  
Christiane Müller  
100% Polypropylene  
Blind ending (as photo above)  
+ suitable for outdoor use  
+ European production  
+ Any size possible  
+ maximum width 5 meters  
+ suitable for residential as well as soft contract





OVER SEAS PRICE LIST

ARTICLE	ARTICLE CODE	COLOR	PRICE P/M <sup>2</sup>
Rug	OVS6501	6501	€ 665,-
	OVS6502	6502	€ 665,-
	OVS6504	6504	€ 665,-
	OVS6505	6505	€ 665,-
	OVS6506	6506	€ 665,-
	OVS6507	6507	€ 665,-
	OVS6508	6508	€ 665,-
	OVS6509	6509	€ 665,-
	OVS6510	6510	€ 665,-
	OVS6511	6511	€ 665,-

PLEASE NOTE! Prices shown are public prices including VAT. The price per m<sup>2</sup> does not include the shipping costs. Click here to see the overview of shipping costs per country (page 3).

OVER SEAS

Available as Rug, outdoor rug  
 Design Frankly Amsterdam  
 Size Any size and shape possible  
 Technique Hand tufted  
 Colors 10 standard  
 Color design Frankly Amsterdam  
 Material 100% Polypropylene  
 Advantages + suitable for indoor and outdoor use  
 + European production  
 + any size and shape possible  
 + suitable for residential as well as soft contract

Note In areas with regular rainfall or high humidity, woven rugs are recommended instead of tufted rugs



RUG EDGE FINISHING OPTIONS



**Overlock edge finish (1 cm)**

This edge finish is available for:

- All Star
- Easy Going
- Front Row
- Good Life
- High Tide
- Next Step
- No Doubt
- On Return (straight or rounded corner)
- Step up 9 (straight or rounded corner)



**Wool overlock edge finish**

This edge finish is available for:

- Lay Out
- Line Up
- Out Line



**Border finish (3cm)**

This edge finish is available for:

- All Star
- Easy Going
- Front Row
- Good Life
- High Tide
- Next Step
- No Doubt



**Hand shaven edge finish**

This edge finish is available for:

- Step Up 16.



**Folded edge finish \***

This edge finish is available for:

- Roll Over

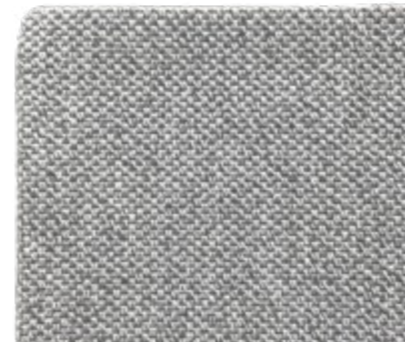

**Folded padded edge finish \***

This edge finish is available for:

- All Star
- Front Row
- Next Step
- No Doubt

\* Please calculate a 10 cm margin around all edges for a rug with folded edge. Maximum rug width for this finish is 380 cm. Rugs with a folded padded edge will have felted padding at the bottom, therefore they can only be used indoors and can not be used for stair runners.

MAXIMUM RUG SIZES WITH EDGE FINISHING

ARTICLE	OVERLOCK EDGE
All Star	400 x 2000 cm
Easy Going	400 x 700 cm, 300 x 700 cm, 200 x 800 cm
Front Row	400 x 2000 cm
Good Life	400 x 700 cm, 300 x 700 cm, 200 x 800 cm
High Tide	400 x 700 cm, 300 x 700 cm, 200 x 800 cm
Lay Out	400 x 2000 cm
Line Up	400 x 2000 cm
Next Step	400 x 2000 cm
No Doubt	400 x 2000 cm
On Return	400 x 700 cm, 300x 7 00 cm, 200 x 800 cm
Out Line	400 x 2000 cm
Step Up 9	400 x 600 cm, 300 x 700 cm, 200 x 800 cm

ARTICLE	BORDER FINISH
All Star	400 x 2000 cm
Easy Going	400 x 600 cm, 300 x 600 cm, 200 x 700 cm
Front Row	400 x 2000 cm
Good Life	400 x 600 cm, 300 x 600 cm, 200 x 700 cm
High Tide	400 x 600 cm, 300 x 600 cm, 200 x 700 cm
Next Step	400 x 2000 cm
No Doubt	400 x 2000 cm

ARTICLE	HAND SHAVEN EDGE FINISH
Step Up 16	400 x 600 cm, 300 x 600 cm, 200 x 700 cm

ARTICLE	FOLDED EDGE FINISH
All Star	380 x 380 cm (final rug size, actual order size is 400 x 400 cm)
Front Row	380 x 380 cm (final rug size, actual order size is 400 x 400 cm)
Next Step	380 x 380 cm (final rug size, actual order size is 400 x 400 cm)
No Doubt	380 x 380 cm (final rug size, actual order size is 400 x 400 cm)
Roll Over	390 x 750 cm



RUG SAMPLE PRICE LIST

ARTICLE	SAMPLE TYPE	SIZE	PRICE P/PIECE
Sample	Tufted/woven sample	15x15cm	€ 25,- *
	Tufted/woven sample	20x20cm	€ 30,- *
	Tufted/woven sample	30x30cm	€ 40,- *
Color box	Eucalyptus color box	110 colors	€ 125,-
	Wool color box	110 colors	€ 125,-
	Mohair color box	110 colors	€ 125,-
	Bamboo color box	77 colors	€ 125,-
	Cotton color box	55 colors + 2 samples	€ 125,-
	Biodegradable PET color box	35 colors + 2 samples	€ 125,-
Sample box	At Ease	10 colors	€ 125,-
	At Random	8 colors	€ 100,-
	Chasing Light	6 colors	€ 100,-
	Colour Me	9 colors	€ 100,-
	Day Light + Pattern	9 colors + 4 patterns	€ 175,-
	Night Fire	8 colors	€ 100,-
	Move Slow	8 colors	€ 100,-
	Saint Cloud	7 colors	€ 125,-
	Perfect Match	8 colors	€ 100,-
	Second Nature	10 colors	€ 125,-
	Super Moon	10 colors	€ 125,-
	Show Off	9 colors	€ 125,-
	Show Off gradient	1 color	€ 50,-
	Un Fold	7 colors	€ 100,-
	Un Fold + big sample	7 colors + big sample	€ 125,-
	Outdoor box	22 colors	€ 175,-
Handwoven box	19 colors	€ 250,-	
Architect box (overview total collection)	all qualities in 2 boxes	€ 450,-	
Sample box	Gradient color poms	Custom	€ 100,- *



\* The price of the sample will be reimbursed via a credit note after placing the order of the corresponding rug.

FRANKLY  
AMSTERDAM

FRANKLY STUDIO RUGS



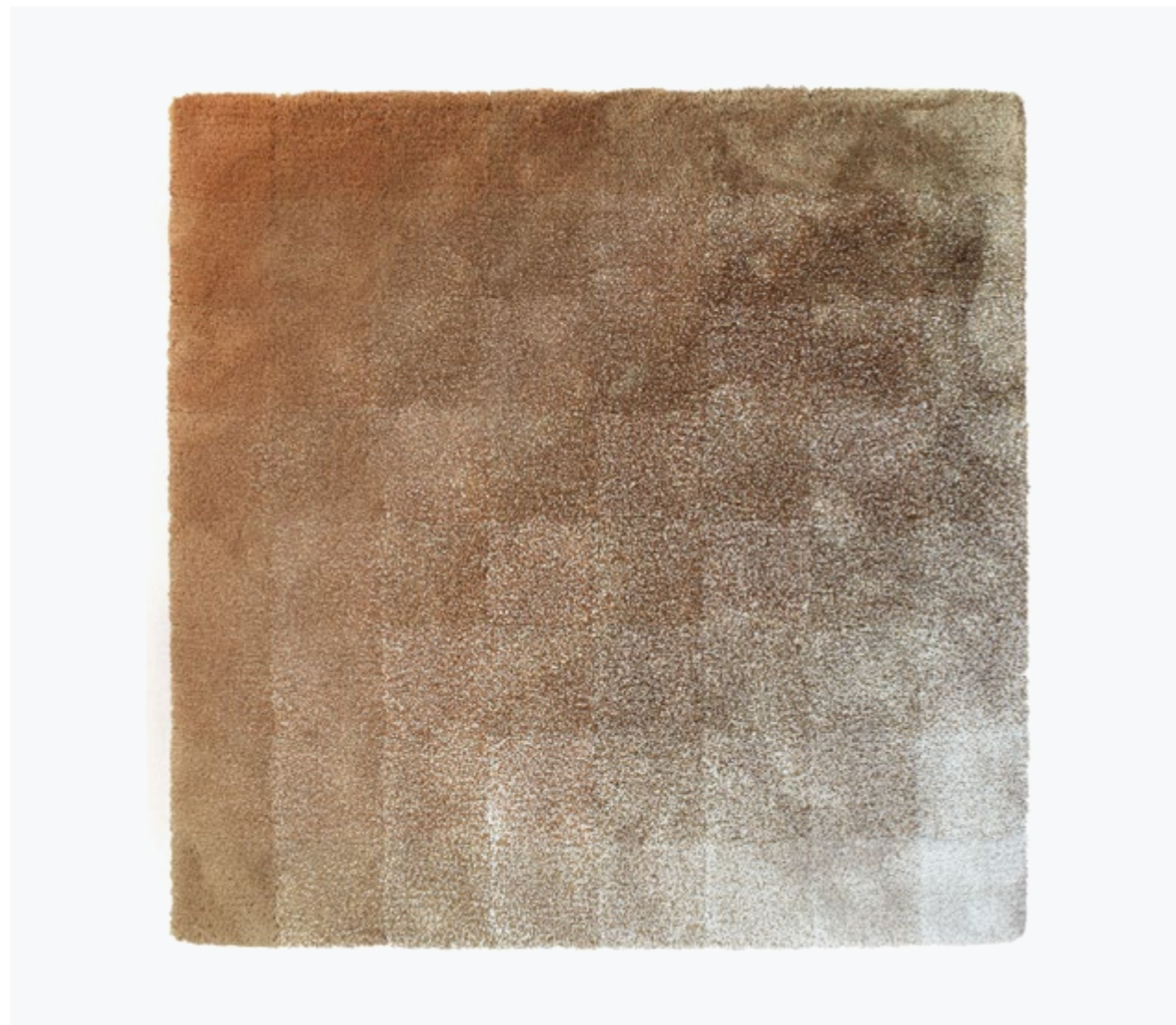

AFTER GLOW

Available as Rug  
 Design Nicemakers  
 Size All sizes possible, if bigger than 250 x 350 cm  
 Weight 5500 gr/m<sup>2</sup>  
 Height 16 mm  
 Technique Handtufted  
 Colors 4 Standard  
 Color design Nicemakers  
 Material 50% Eucalyptus, 50% Mohair  
 Fire classification Eucalyptus Cfl-s1, Mohair Bfl-s1  
 Advantages  
 + delivery time for this rug is 6 weeks  
 + exclusive design  
 + special graphic look  
 + extremely high quality Mohair and Eucalyptus yarn  
 + pattern scales along with the size of the rug  
 + suitable for residential as well as soft contract

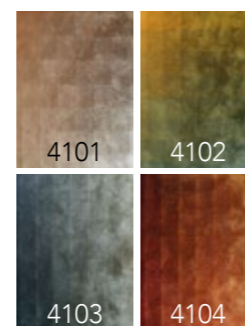

AFTER GLOW PRICE LIST

ARTICLE	ARTICLE CODE	COLOR	PRICE P/M <sup>2</sup>
Rug	AFG4101	4101	€ 1.039,-
	AFG4102	4102	€ 1.039,-
	AFG4103	4103	€ 1.039,-
	AFG4104	4104	€ 1.039,-

PLEASE NOTE! Prices shown are public prices including VAT. The price per m<sup>2</sup> does not include the shipping costs. Click here to see the overview of shipping costs per country (page 3).



CAPITAL CITY

Available as Rug, wall rug  
 Design Els van Egmond  
 Size All sizes possible, from 200x300cm  
 Weight 5000 gr/m<sup>2</sup>  
 Height 10 mm & 14 mm  
 Technique Handtufted and hand carved  
 Colors 6 Standard  
 Color design Els van Egmond  
 Material 100% New Zealand Wool  
 Fire classification Bfl-s1  
 Advantages  
 + delivery time for this rug is 4-6 weeks  
 + exclusive design  
 + special graphic look  
 + extremely high quality New Zealand Wool  
 + pattern scales along with the size of the rug

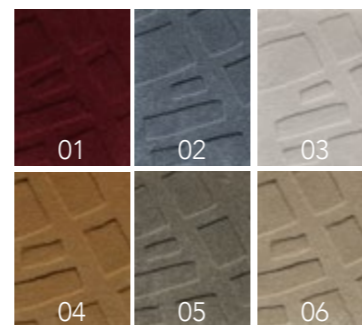

CAPITAL CITY PRICE LIST

ARTICLE	ARTICLE CODE	COLOR	PRICE P/M <sup>2</sup>
Rug	CAC01	01	€ 1.099,-
	CAC02	02	€ 1.099,-
	CAC03	03	€ 1.099,-
	CAC04	04	€ 1.099,-
	CAC05	05	€ 1.099,-
	CAC06	06	€ 1.099,-

PLEASE NOTE! Prices shown are public prices including VAT. The price per m<sup>2</sup> does not include the shipping costs. Click here to see the overview of shipping costs per country (page 3).

Pattern example 200 x 300 cm

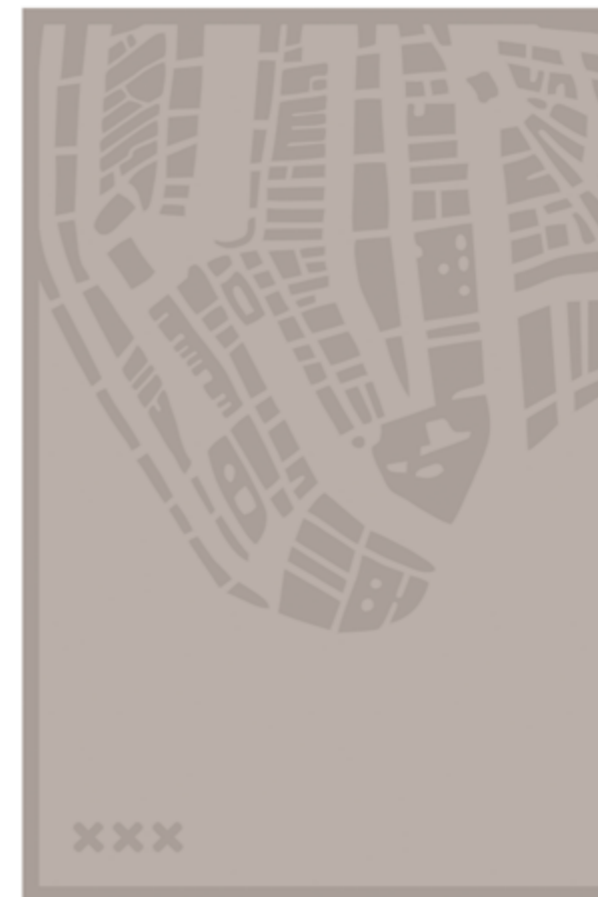



EN SUITE PRICE LIST

ARTICLE	ARTICLE CODE	COLOR	PRICE P/M <sup>2</sup>
Rug	ENS3201	3201	€ 1.066,-
	ENS3202	3202	€ 1.066,-
	ENS3203	3203	€ 1.066,-
	ENS3204	3204	€ 1.066,-
	ENS3205	3205	€ 1.066,-
	ENS3206	3206	€ 1.066,-

PLEASE NOTE! Prices shown are public prices including VAT. The price per m<sup>2</sup> does not include the shipping costs. Click here to see the overview of shipping costs per country (page 3).

EN SUITE

Available as Rug  
 Design Mae Engelgeer  
 Size Any size possible, based on squares of 50 x 50 cm  
 Weight 6500 gr/m<sup>2</sup>  
 Height 8 mm (loop), 15 mm (degrade), 35 mm (high pile)  
 Technique Hand tufted  
 Colors 6 Standard  
 Color design Mae Engelgeer  
 Material 70% Eucalyptus, 30% Wool  
 Fire classification Eucalyptus Cfl-s1, Wool Bfl-s1  
 Advantages + unlimited size, if dividable by 50 cm in both width and length  
 + exclusive design  
 + special, graphic look  
 + dynamic 3D effect





**FULL CIRCLE**

Available as Rug  
 Design Mae Engelgeer  
 Size All sizes possible  
 Weight 5500 gr/m<sup>2</sup>  
 Height 8mm (loop), 10mm (low pile), 24mm (high pile)  
 Technique Hand tufted  
 Colors 9 Standard  
 Color design Mae Engelgeer  
 Material 99% Mohair (details of Wool and Eucalyptus)  
 Fire classification Mohair Bfl-s1 (Wool Bfl-s1, Eucalyptus Cfl-s1)  
 Advantages  
 + unlimited size  
 + exclusive design  
 + special graphic look  
 + dynamic 3D effect  
 + extremely high quality Mohair yarn



**FULL CIRCLE PRICE LIST**

ARTICLE	ARTICLE CODE	COLOR	PRICE P/M <sup>2</sup>
Rug	FUC3601	3601	€ 875,-
	FUC3602	3602	€ 875,-
	FUC3603	3603	€ 875,-
	FUC3604	3604	€ 875,-
	FUC3605	3605	€ 875,-
	FUC3606	3606	€ 875,-
	FUC3607	3607	€ 875,-
	FUC3608	3608	€ 875,-
	FUC3609	3609	€ 875,-

PLEASE NOTE! Prices shown are public prices including VAT. The price per m<sup>2</sup> does not include the shipping costs. Click here to see the overview of shipping costs per country (page 3).



**NIGHT FIRE PATTERN**

Available as	Rug
Design	Nicemakers
Size	Any size possible, if bigger than 200 x 300 cm
Weight	5500 gr/m <sup>2</sup>
Height	16 mm
Technique	Hand tufted
Colors	1 Standard, with 19 color mixes
Color design	Nicemakers
Material	100% Eucalyptus
Fire classification	Cfl-s1
Advantages	+ any size possible (bigger than 200 x 300 cm) + soft and suitable for sensitive skin + suitable for residential as well as soft contract + delivery time in 6 weeks



**NIGHT FIRE PATTERN PRICE LIST**

ARTICLE	ARTICLE CODE	COLOR	PRICE P/M <sup>2</sup>
Rug	NIF5509	5509	€ 919,-

PLEASE NOTE! Prices shown are public prices including VAT. The price per m<sup>2</sup> does not include the shipping costs. Click here to see the overview of shipping costs per country (page 3).

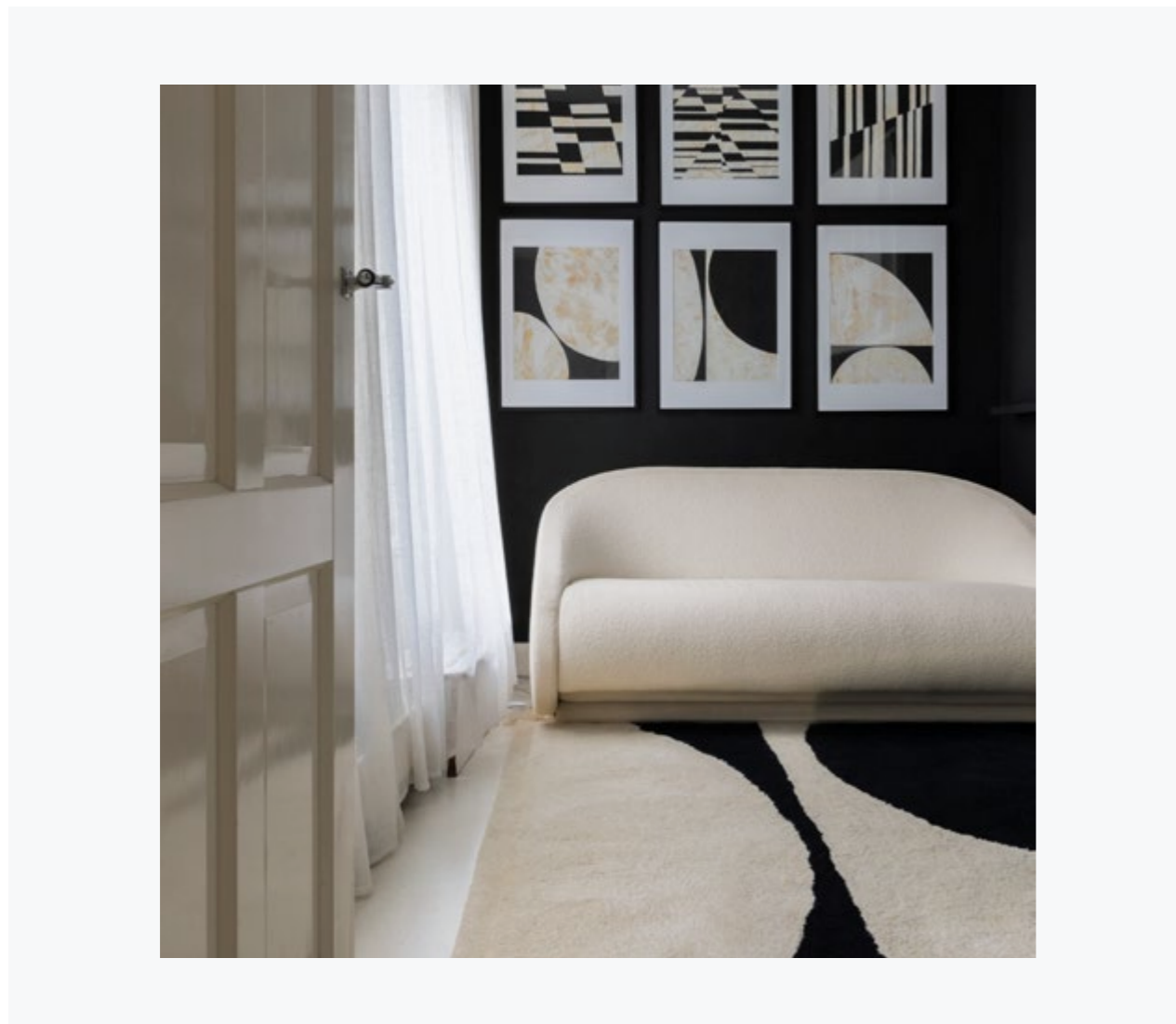

THE MOON PRICE LIST

ARTICLE	ARTICLE CODE	COLOR	PRICE P/M <sup>2</sup>
Rug	THM8701	8701	€ 950,-

PLEASE NOTE! Prices shown are public prices including VAT. The price per m<sup>2</sup> does not include the shipping costs. Click here to see the overview of shipping costs per country (page 3).

THE MOON

Available as	Rug
Design	Art in Return
Size	170x240cm, 210x300cm, 250x350cm, 320x450cm
Weight	3500 gr/m <sup>2</sup>
Height	12 mm + 35 mm
Technique	Hand tufted
Colors	2 standard colors + any custom color
Material	100% Wool
Fire classification	Bfl-s1
Advantages	<ul style="list-style-type: none"> <li>+ any size possible within the same ratio.</li> <li>+ possibility to create your own mix color out of 110 uni colors (see wool box)</li> <li>+ graphic design by Art in Return</li> <li>+ a strong and soft fiber</li> <li>+ naturally heat regulating, suitable in all seasons</li> </ul>

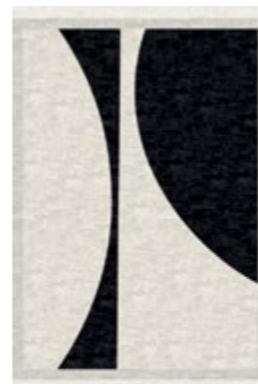





VERTICAL TRANSFORMATION WALL RUG PRICE LIST

ARTICLE	ARTICLE CODE	SIZE	PRICE P/PIECE
Wall rug	VET5901	140 x 140 cm	€ 7.575,-
	VET5902	140 x 140 cm	€ 9.999,-

A hanging system can be ordered separately. Read the information on the next page or contact us for more info.

PLEASE NOTE! Prices shown are public prices including VAT. The price per m<sup>2</sup> does not include the shipping costs. Click here to see the overview of shipping costs per country (page 3).

VERTICAL TRANSFORMATION

Available as Wall rug  
 Design Claes Iversen  
 Size 140 x 140 cm, contact our studio for special sizes  
 Height 10 - 30 mm  
 Technique Hand tufted and hand knotted  
 Colors 1 Standard, custom color block available for VET5902 (see right side)  
 Color design Claes Iversen  
 Material Eucalyptus, Wool, Mohair, Wool fringes  
 Fire classification Eucalyptus Cfl-s1, Mohair + Wool Bfl-s1  
 Advantages + home couture  
 + European production  
 + improves acoustics  
 + functional and pretty to watch



Adjust color 107 to one of these pre-selected colors, or any other color from our Eucalyptus colorbox.

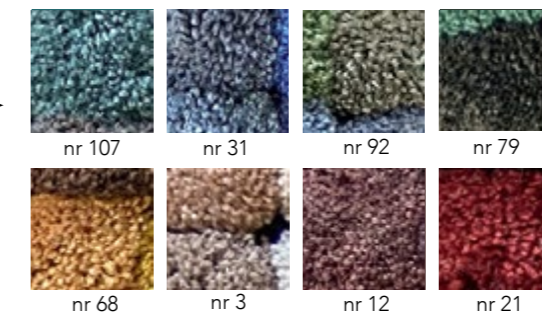



**HANGING SYSTEM**

Applicable to	Wall rugs
Size	Standard up to 150 cm, please contact us for sizes above 150 cm
Technique	French cleat system
Material	Wood of aluminium
Content	2 pre-drilled slats including screws and plugs



**HANGING SYSTEM PRICE LIST**

ARTICLE	ARTICLE CODE	SIZE	PRICE P/PIECE
-	Hanging system wood	up to 150 cm	€ 99,-*
-	Hanging system aluminium	up to 150 cm	€ 199,-*

\* Purchase price excluding VAT, not consumer price including VAT.

Please contact us for more information regarding hanging systems above 150 cm.



#### EUCALYPTUS COLOR BOX

##### WHY EUCALYPTUS?

Eucalyptus has a number of great advantages:

- + its smooth surface and soft touch
- + longlasting shine
- + amazing moisture management
- + naturally antibacterial
- + suitable to sensitive skin

Eucalyptus is also a responsible material in many ways:

- + the wood for this fibre comes from sustainable European forests
- + 99,5% of production solvents are recovered and re-used
- + requires only 2,8% of the water needed to produce cotton
- + the fibre is completely biodegradable
- + we have a responsible dyeing process

##### OUR COLOR OPTIONS

We have an extensive range of color options for our Eucalyptus yarn:

- + 110 uni colors for Move Slow, Perfect Match & Chasing Light qualities
- + 51 uni colors for At Random and Colour Me qualities
- + a possibility to mix your own color out of these uni colors
- + a possibility to have custom colors lab-dyed (contact us for more info)



#### WOOL COLOR BOX

##### WHY WOOL?

- + stainresistant and naturally anti-bacterial
- + natural and effective moisture management
- + excellent natural elasticity
- + a strong and soft fiber
- + highly wear-resistant
- + naturally heat regulating, suitable in all seasons

Wool is also a responsible material in many ways:

- + our Wool comes strictly from sheep living in Europe
- + the Wool fiber is completely biodegradable
- + Wool is a renewable product
- + our processes are all animal friendly
- + the dyeing of our Wool yarn is 100% ecological

##### OUR COLOR OPTIONS

We have an extensive range of color options for our Wool yarn:

- + 110 uni colors for the thicker Wool yarn (100% virgin Wool)
- + 81 colors for thin Wool yarn (a mix of 20% Mohair and 80% virgin Wool), used in En Suite
- + a possibility to mix your own color out of these uni colors
- + a possibility to have custom colors lab-dyed (contact us for more info)



**MOHAIR COLOR BOX**

**WHY MOHAIR?**

- + a strong and soft fiber
- + deep and brilliant colors
- + stainresistant and naturally anti-bacterial
- + natural and effective moisture management
- + excellent natural elasticity
- + highly wear-resistant

Mohair is also a responsible material in many ways:

- + the Mohair fiber is completely biodegradable
- + Mohair is a renewable product
- + our processes are all animal friendly
- + the dyeing of our Wool yarn is 100% ecological

**OUR COLOR OPTIONS**

We have an extensive range of color options for our Mohair yarn:

- + 110 uni colors for all Mohair qualities, like Super Moon, En Suite and Full Circle
- + a possibility to mix your own color out of these uni colors
- + a possibility to have custom colors lab-dyed (contact us for more info)



**BAMBOO COLOR BOX**

**WHY BAMBOO?**

- + soft to the skin
- + velvet look with a luxurious appearance
- + vibrant coloring with a melange look
- + anti-bacterial and suitable for people with allergies
- + smell resistant

Bamboo is also a responsible material in many ways:

- + Bamboo yarn is environmental friendly
- + it comes from a natural and sustainable source
- + it is a renewable source and the fastest growing woody plant on our planet
- + it releases abundant oxygen into the atmosphere
- + the dyeing of our Bamboo yarn is eco-friendly

**OUR COLOR OPTIONS**

We have an extensive range of color options for our Bamboo yarn:

- + 77 uni colors for Bamboo qualities like Day Light and Show Off
- + a possibility to mix your own color up to 6 colors from the color box
- + a possibility to have custom colors lab-dyed (contact us for more info)



#### BIODEGRADABLE PET COLOR BOX

##### WHY BIODEGRADABLE PET?

- + thanks to its PET characteristics, this yarn is exceptionally strong, making it an excellent choice for high-traffic areas
- + the transformation process of post-consumer PET bottles into yarns results in a wool-like softness
- + this non-absorbent yarn is effortless to maintain
- + incredibly easy to clean
- + hypoallergenic, making it a suitable option for individuals with allergies

Biodegradable PET is a responsible material in many ways:

- + made from post-consumer recycled plastic bottles
- + recycling a single PET bottle can conserve enough energy to light a 60 watt bulb for up to 6 hours
- + under the correct circumstances this yarn is 100% biodegradable within 12 months in landfill and/or sea water

- + Soil left behind from the degradation process contains no plastic and remains perfectly suitable for plant growth
- + It is important to note that this PET is only biodegradable under the correct circumstances and should not be mixed with regular plastic waste.

##### OUR COLOR OPTIONS

- + 35 uni colors
- + a possibility to mix your own color up to 6 colors from the color box
- + a possibility to have custom colors lab-dyed (contact us for more info)



#### COTTON COLOR BOX

##### WHY COTTON?

- + an exceptionally soft and fluffy texture
- + a fiber that can be easily washed and cleaned
- + it offers a dense appearance with a remarkably soft touch
- + hypoallergenic, making it a suitable option for individuals with allergies
- + due to its natural characteristic, Cotton yarn is highly absorbent, preventing electrostatic charging
- + resilient yarn which can recover into its original shape

Cotton is also a responsible material in many ways:

- + the OKO-TEX STANDARD 100 GMO guarantees every component of this product has undergone rigorous testing to eradicate any harmful substances

- + made out of organic cotton, meaning only natural methods and no toxic chemicals have been used during the farming process
- + the seeds to produce organic cotton are non-GMO (free of contaminations)
- + a renewable resource that is 100% natural and therefore biodegradable

##### OUR COLOR OPTIONS

- + 55 uni colors
- + a possibility to mix your own color up to 10 colors from the color box
- + a possibility to have custom colors lab-dyed (contact us for more info)

#### CARE INSTRUCTIONS INDOOR RUGS

All our products are made with care and attention. In order to keep them as beautiful as they are, please mind the following care instructions:

- We advise you to vacuum the rug once or twice a week with a normal (upright or cylinder) vacuum cleaner but without the brush or beater bar engaged. Rugs with a high pile need to be vacuumed more often.
- Do not use a vacuumer with a rotating brush, this will damage the yarn.
- Rugs made from natural materials are subject to some pilling during the first few months. This is a common characteristic of natural cut fibers and will disappear after 3 or 4 months of normal use.
- A dry environment can result in extra pilling of the yarn. A humidity between 50-70% will benefit the lifecycle of your rug.
- In order to avoid 'regular use marks', we advise you to turn the rug every once in a while.
- Wet stains need to be removed immediately, before the yarn absorbs the fluid. Absorb the stain using a strong absorbing paper (like kitchen paper). Do not, in any case, rub or put pressure on the rug when wet. This can damage the fibers and the structure of the rug.
- Light stains can safely be treated with JAMES cleaning agents, which have been successfully tested on our products. Please follow the instructions of the JAMES staindisc, also shown on our site. We can not guarantee safe use of cleaning agents by any other brand, since they have not been tested.
- Please do not use highly acidic cleaning agents to remove stains from your rug. This will cause discoloration of the yarn.
- In case of heavy staining or transferred dirt, we advise you to always have your rug drycleaned by a specialist in rug cleaning. Please state clearly that this rug needs to be cleaned without using water.
- When in doubt, please don't hesitate to contact us, or take a look on our website, [www.frankly.amsterdam/careinstructions](http://www.frankly.amsterdam/careinstructions), for more information.

#### CARE INSTRUCTIONS OUTDOOR RUGS

- We recommend regular (monthly) cleaning of the outdoor rug.
- Vacuum the rug with a normal (upright or cylinder) vacuum cleaner without the brush or beater bar engaged. Avoid vacuuming over 1200W.
- After vacuuming, you can use cold water with a pH neutral soap or a non-ionic detergent to remove all dirt on both sides of the rug. Dry the rug in the sun afterwards.
- Stains need to be removed as soon as possible. Absorb the stain using a strong absorbing paper (like kitchen paper) or a clean cloth.
- Remove stains using pH neutral soap or dish soap and scrub it gently with warm water.
- Do not use highly acidic cleaning agents to remove stains from your rug. This can cause discoloration of the yarn.
- In case of heavy staining we advise you to always have your rug cleaned by a specialist in rug cleaning.
- To avoid the rug getting moldy hang or lay down the rug in sunlight on a clean surface. For the rug to be completely dry, alternate the sides.
- If there's no drainage under the rug, move it to sunlight to air dry properly.
- In areas with regular rainfall or high humidity, woven rugs are recommended instead of tufted rugs.
- If you would like to storage your outdoor rug you need to clean it properly first. Make sure you never fold your rug. You have to roll it up, wrap it in plastic and secure it with tape for example.
- When in doubt, please don't hesitate to contact us, or take a look on our website, [www.frankly.amsterdam/careinstructions](http://www.frankly.amsterdam/careinstructions), for more information.

#### WARRANTY

- Frankly Amsterdam guarantees its rugs for 2 years of normal use.
- All our products are made with care. In case a manufacturing defect escaped our attention, please inform us within 14 days after delivery and leave the product unused.
- Small differences or irregularities in color, weft or size may occur. This is inherent to the use of natural fibers and has to be accepted when within normal commercial tolerances.
- Frankly Amsterdam will not accept any complaint if shading is concerned.

