

viewlite^x

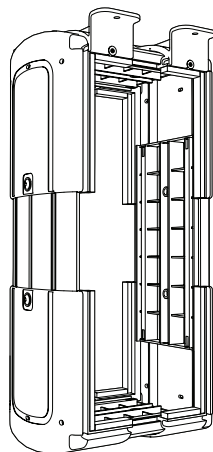

35.200

35.203

v1.0

Installation manual/Installatie handleiding
Installations-handbuch/Manuel d'installation
Manuale d'installazione/Manual de instalación
Copyright © 2015 – Dataflex International BV

T +31 180 515444
F +31 180 518540
info@dataflex-int.com
www.dataflex-int.com



horizontal
vertical



156 - 205 mm
(6,1 - 8,0")



390 - 570 mm
(15,3 - 22,4")



30 kg

Parts/Onderdelen/Teile/Pièces/Parti/Partes

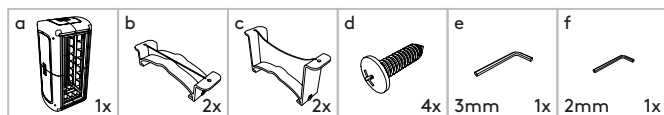

Required tools/Benodigd gereedschap/Benötigtes Werkzeug/Outils requis/Strumenti necessari/Herramientas necesarias

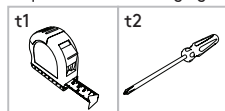

dataflex

feeling at work

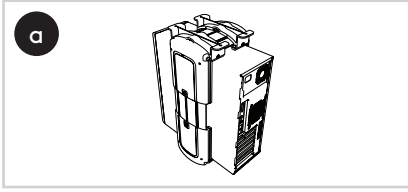

or/of/oder/o

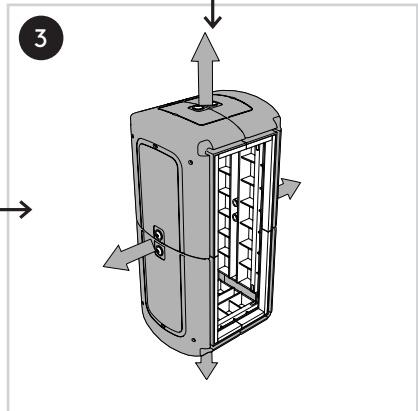
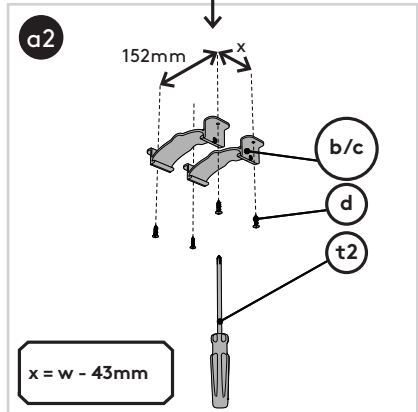
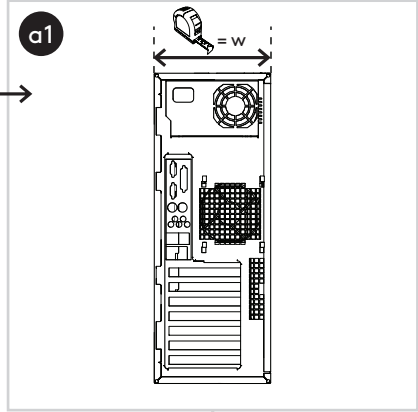
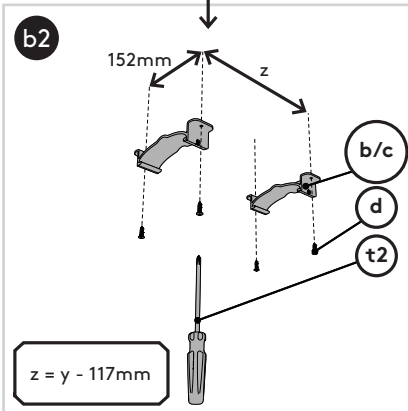
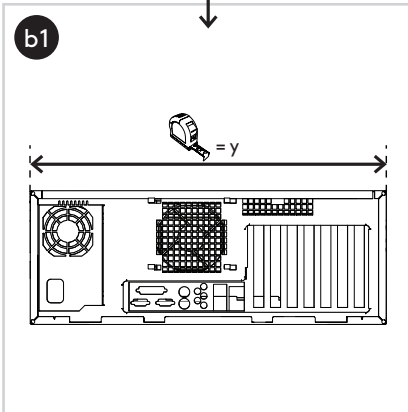
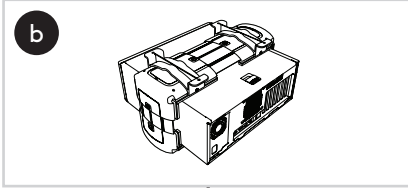

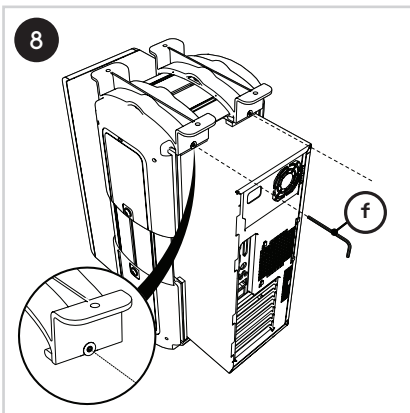
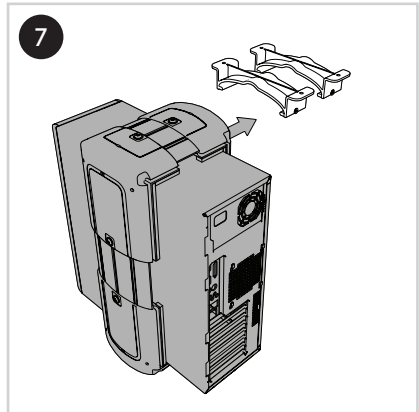
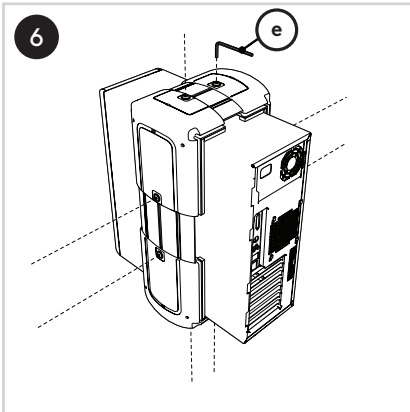
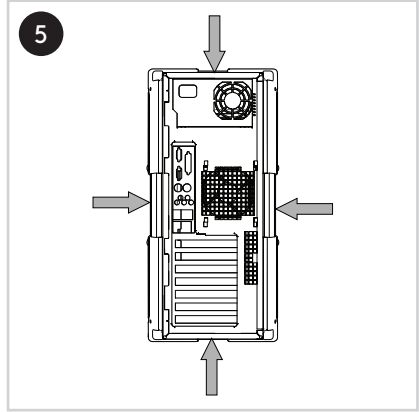
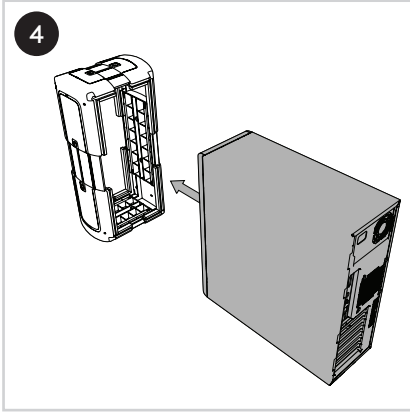

No rights can be derived from this publication/
Aan deze uitgave kunnen geen rechten worden
ontleend/Aus dieser Ausgabe können keine
Rechte abgeleitet werden/Aucun droit ne peut
découler de cette publication/Dal presente
documento non deriva alcun diritto/Del
contenido de esta publicación no podrá
derivarse ningún derecho