

digitalSTROM

dS-DinClip200

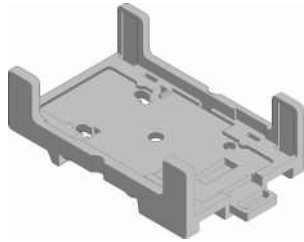

digitalSTROM AG
www.digitalstrom.com
A14224B001V001

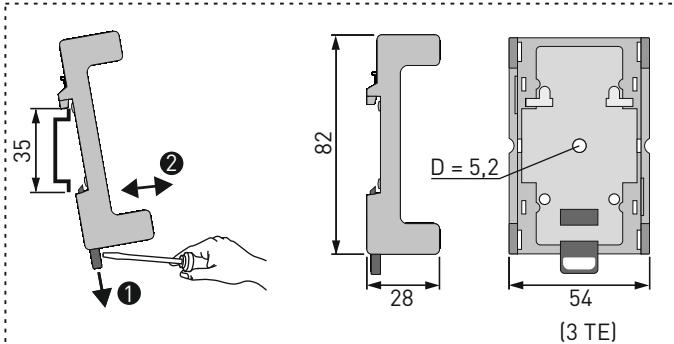

°C -20 °C ... +60 °C

% < 80 % rH

0.5 Nm

3 mm (mm)

TECHNICAL DATA

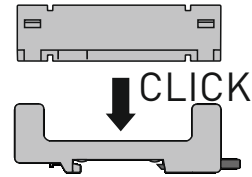

dS-DinClip200 + 1x UMx

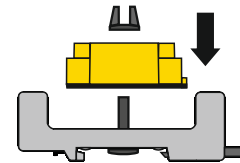

dS-DinClip200 + 1x KL

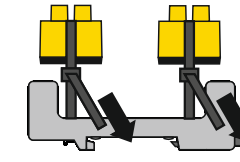

dS-DinClip200 + 2x KM/TKM/AKM

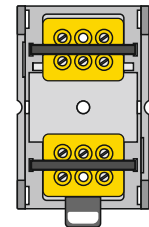
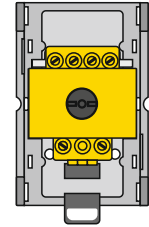
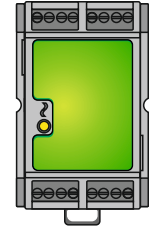

Subject to technical changes.

Further information can be found on our website.

www.digitalstrom.com/products/mta/A14224B001V001