

HSG Panini Service manual

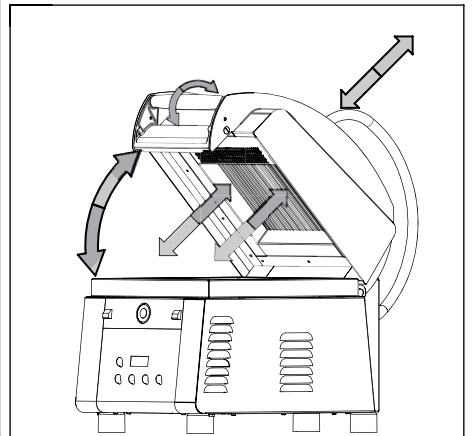

CE

DIMENSIONS (inch)	A	27 - (686 mm)	
	B	14,2 - (361 mm)	
	C1	24,8 - (630 mm)	
	C2	31,5 - (800 mm)	
	D	19,2 - (488 mm)	
WEIGHT (lb)	KG	36	
ELECTRICAL	V	USA 208	EUROPE 400
	W	5000	5000
	HZ	60	50
	A	26	8
	PH	1	3+N

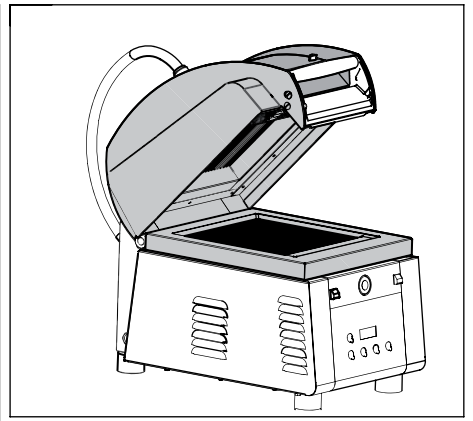

2 inch (50mm)

2 inch (50mm)

7,5 inch (190mm)

9 inch (250mm)

5 inch (130mm)

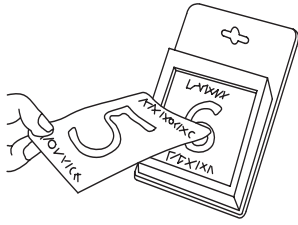

DAILY 7/7

A

1

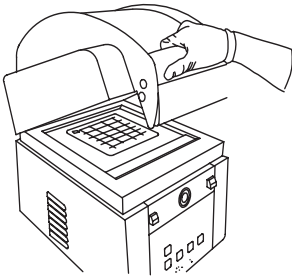

2

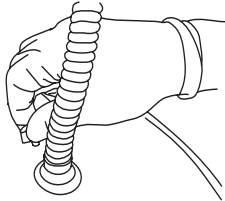

3

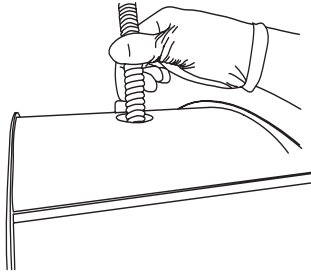

4

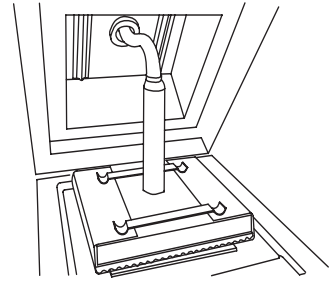

5

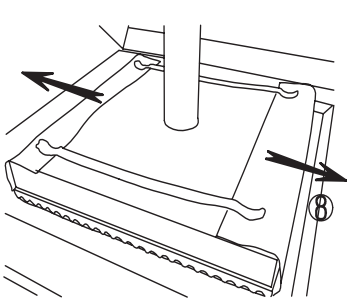

6

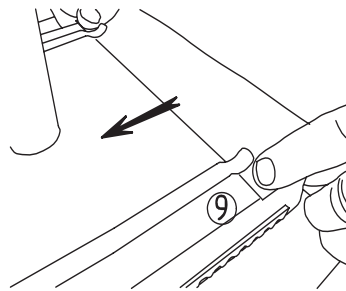

7

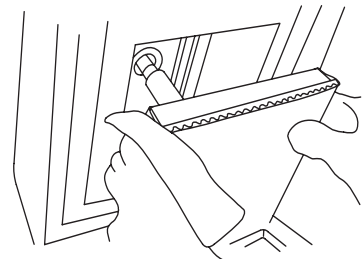

B

1

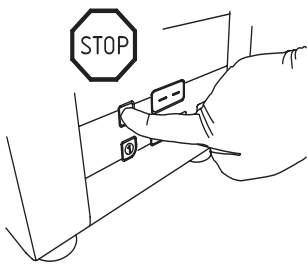

2

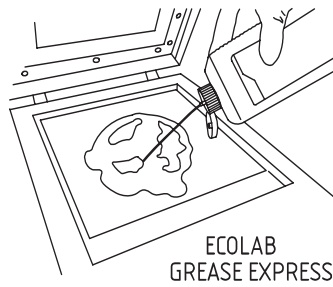

3

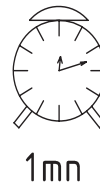

4

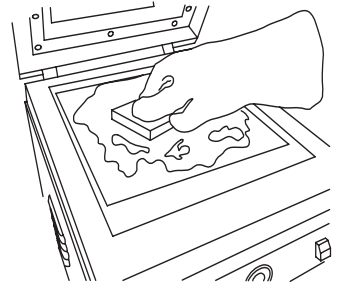

5

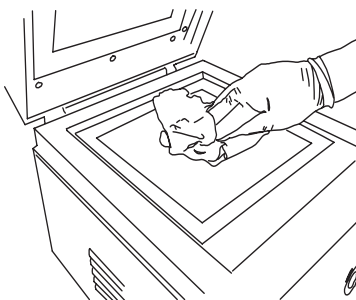

6



7

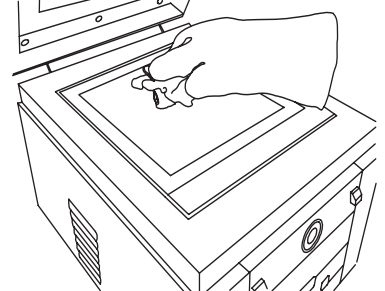

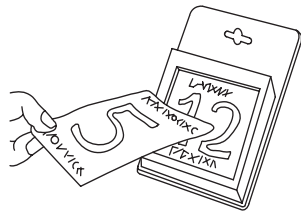

WEEKLY 1/7

A

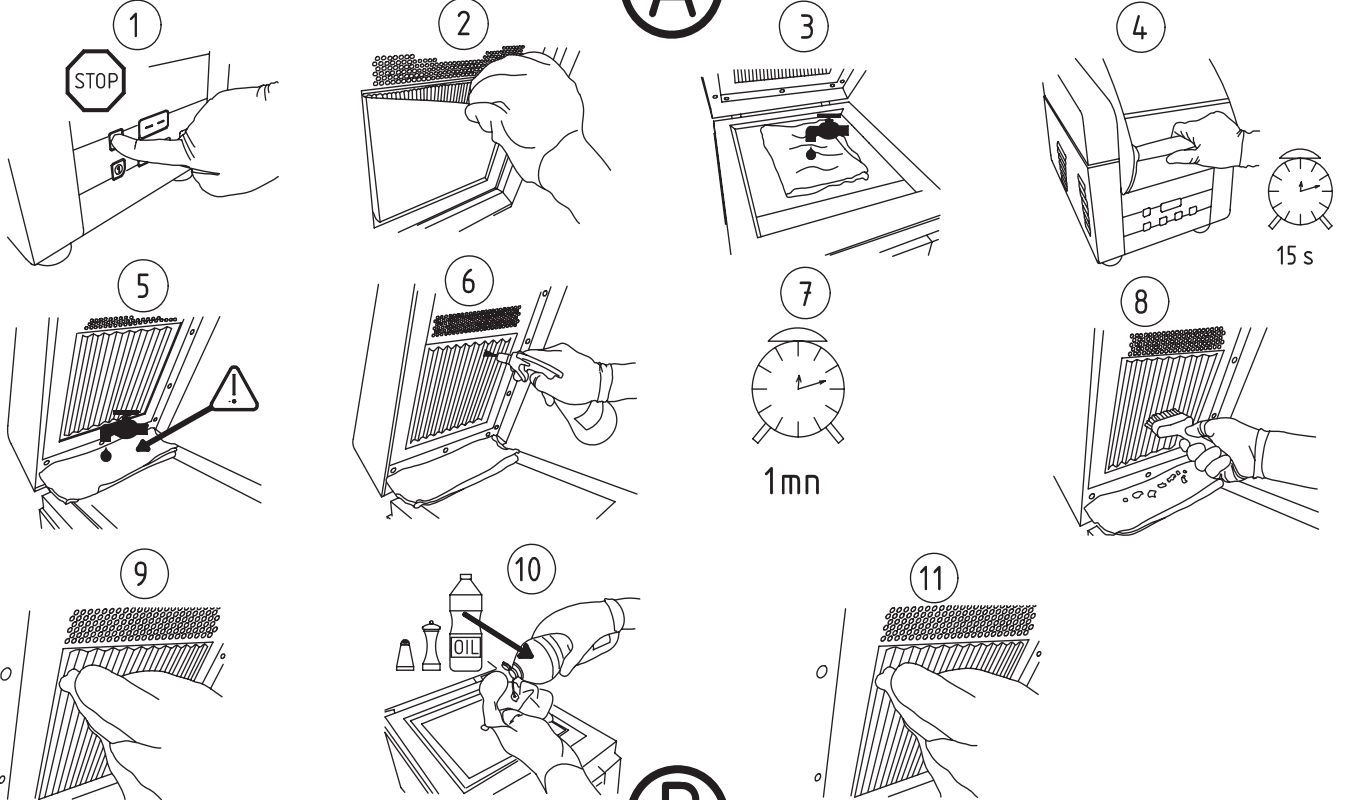

B

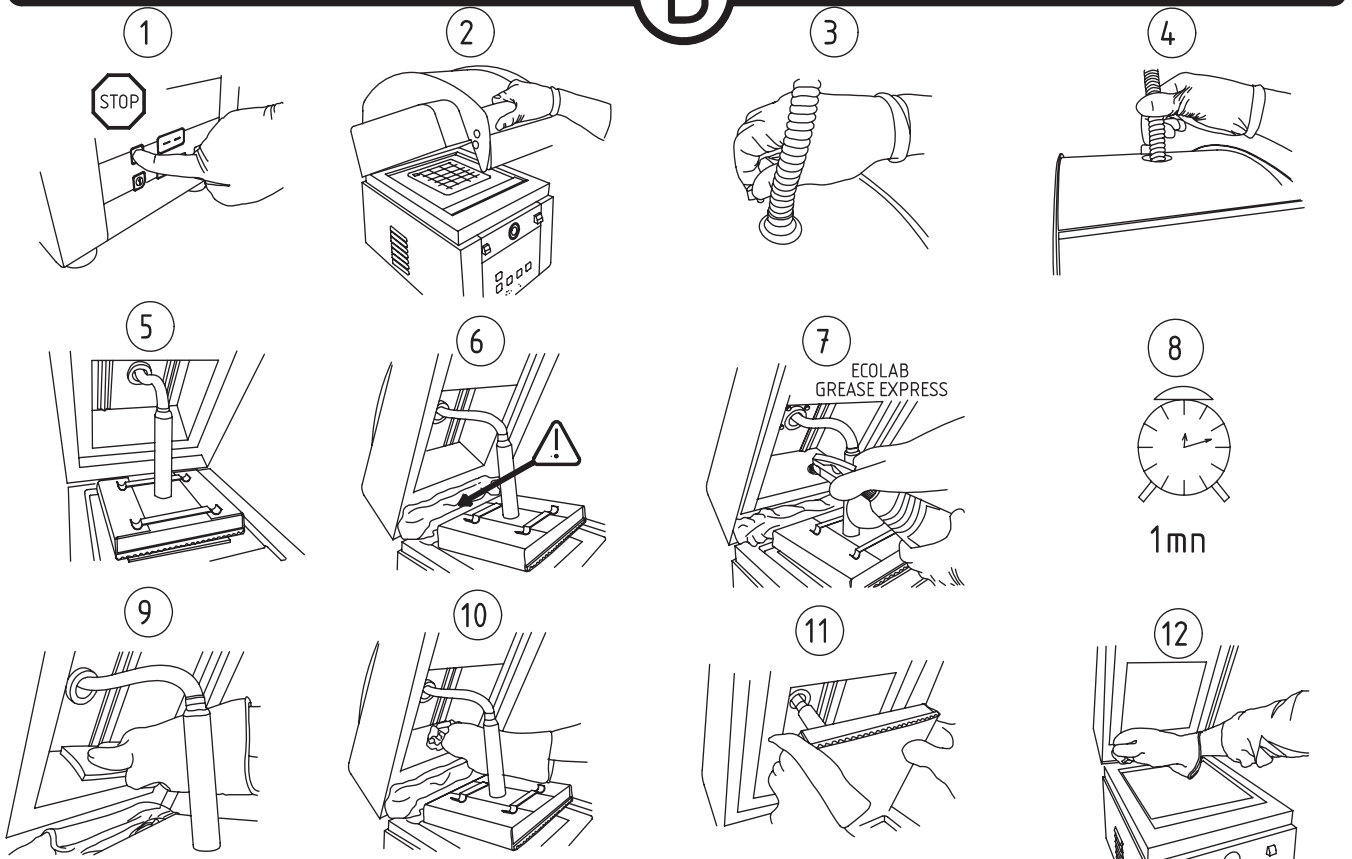



This document is to be used in conjunction with the original manufacturer's manual.
The symbols correspond with the numbered drawings of the original manual

GB
07/2009

Service Manual

Index

Short explanation of the appliance	1	Explanation on software settings (logigram)	7
List of required instruments for maintenance & repair	4	Settings table	8
Check list for each intervention on the machine	4	Parameters	10
Troubleshooting	5	Repair section	20
Error codes	6	Exploded View	A
How to enter the Program mode	6		

1. Explanation of the appliance

1-1 IMPORTANT SAFETY INSTRUCTIONS

Carefully read this booklet as it gives important information concerning safe maintenance.

Install or locate this appliance only in accordance with the provided installation instructions

The following terms given in the service manual indicate a potentially hazardous condition for the operator, service personnel or for the appliance.

- **Danger!** This term warns of an immediate danger that could lead to considerable damage or death.
- **Warning!** This term indicates the potential risk of considerable damage or death following improper use or service of the appliance.
- **Important!** This term indicates information that must be thoroughly understood, although not indicating danger.

Warning! Danger of fire.

For your safety, do not keep gasoline or other flammable liquid or gaseous materials in the vicinity of this or other appliances. Keep the area around the appliance clear and free of combustibles. Do not use this appliance in an explosive atmosphere.



Warning!

Only install the appliance in a well-ventilated place. Inadequate ventilation causes asphyxia. Do not obstruct the ventilation system of the place where the appliance is installed. Do not obstruct the vent holes located at the sides and back of this appliance.



Important!

-  - Appliance installation and any maintenance work must be carried out only by specialized personnel authorized by the manufacturer. Install or locate this appliance in a well-lit place.

- Place emergency telephone numbers in a visible position.
- For assistance, contact an authorized technical centre. Demand original spare parts.
- This appliance is designed for cooking food. It is intended for industrial use. Any other use is to be considered improper
- The appliance can't be used by handicapped people or children but only by responsible and trained operators.
- Do not leave the appliance unattended when operating.
- Unplug the appliance in case of a fault or poor operation.
- Do not use products (even if diluted) containing chlorine (sodium hypochlorite, hydrochloric or muriatic acid, etc.) to clean the appliance. Do not use metal tools to clean steel parts or the glass surface (wire brushes or Scotch Brite type scouring pads).
- Do not allow dirt, fat, food or other residue to form deposits on the appliance.
- Do not wash the appliance with direct jets of water.

Failure to observe the above can compromise the safety of the appliance.

Failure to observe the above invalidates the warranty.

WARNING

TO REDUCE THE RISK OF BURNS, ELECTRIC SHOCK, FIRE, INJURY TO PERSONS, OR EXPOSURE TO EXCESSIVE MICROWAVE ENERGY:

- 1) Do not use the appliance empty
- 2) Read and follow the specific «PRECAUTIONS TO AVOID POSSIBLE EXPOSURE TO EXCESSIVE MICROWAVE ENERGY» found in chapter 3 of the user manual
- 3) This appliance must be grounded. Connect only to properly grounded outlet. See «GROUNDING INSTRUCTIONS» found on chapter 2-9 of the user manual
- 4) Install or locate this appliance only in accordance with the provided installation instructions
- 5) Some products such as whole eggs and sealed containers - for example, closed glass jars - are able to explode and could not be heated in this appliance.
- 6) Use this appliance only for its intended use as described in the user manual. Do not use corrosive chemicals or vapours in this appliance. This type of appliance is specifically designed to heat or cook FOOD. It is not designed for laboratory use.
- 7) As with any professional appliance, it can not be used by handicapped people or children.
- 8) Do not operate this appliance if it has a damaged cord or plug, if it is not working properly, or if it has been damaged or dropped.
- 9) This appliance should be serviced only by qualified service personnel. Contact nearest authorized service facility for examination, repair, or adjustment.
- 10) Do not cover or block any openings on the appliance.
- 11) Do not store this appliance outdoors. Do not use this product near water - for example, near a kitchen sink, in a wet basement, near a swimming pool, or similar locations.
- 12) Do not immerse the appliance, the upper heating plate, cord or plug in water.
- 13) Keep cord away from heated surfaces.
- 14) Do not let the cord hang over the edge of a table or counter.
- 16) To reduce the risk of fire in the heating cavity:
 - I) Do not overcook food. DO NOT place plastic, or other combustible materials, cooking utensils or other item in all materials it could be inside the appliance. ONLY FOOD, with the designated specific baking paper.
 - II) If materials inside the appliance ignite, turn appliance off, and disconnect the power cord.
 - III) Do not leave things on the glass, do not use the cooking chamber for storage purposes. Do not leave paper products, cooking utensils, or food in the cavity when not in use.
 - IV) Do not put metallic recipient or any kind of kitchenware, tools.
 - V) Clean regularly the glass and the upper heating plate. Carbon deposit could overheat the food.
- 18) The maximum height of the food to be cooked must not overpass 3"/75mm.
- 19) In use and after use the appliance risks to have hot surfaces, be aware of touching the appliances (especially all the lid and its heating plate, the glass...).
- 20) As in any Microwave appliance, it can occur to have sparks inside the cooking chamber. These sparks do not influence the safety of the user nor the appliance nor the quality of the food. If, as a consequence of the sparking, a dark mark on the metal parts is visible, this can be cleaned with a damp cloth.

SAVE THESE INSTRUCTIONS CAREFULLY FOR FURTHER CONSULTATION BY THE VARIOUS OPERATORS

**PRECAUTIONS TO BE OBSERVED BEFORE AND DURING SERVICING TO
AVOID POSSIBLE EXPOSURE TO EXCESSIVE MICROWAVE ENERGY**

- (a) Do not operate or allow the appliance to be operated with the lid open.**
- (b) Make the following safety checks on all appliances to be serviced before activating the magnetron or other microwave source, and make repairs as necessary: (1) interlock operation, (2) proper lid closing, (3) contact surfaces (arcing, wear, and other damage), (4) damage to or loosening of hinges and latches, (5) evidence of dropping or abuse.**
- (c) Before turning on microwave power for any service test or inspection within the microwave generating compartments, check the magnetron, wave guide or transmission line, and cavity for proper alignment, integrity, and connection.**
- (d) Any defective or misadjusted components in the interlock, user interface, contact surfaces, and microwave generation and transmission systems shall be repaired, replaced, or adjusted by procedures described in this manual before the appliance is released to the owner**
- (e) A microwave leakage check to verify compliance with the standards should be performed on each appliance prior to release to the owner.**

1-2 EXPLANATION OF THE APPLIANCE:

The appliance is a product specifically designed for Hot Sandwich Outlets, with the following main characteristics:

- Great tasting, hot, toasted Sandwich in about less than 60" (depending on the sandwich), in a one-step-solution;
- Combining the quality of latest Panini Grill technology with the speed of Micro-Wave Technology;
- The HSG has been designed to be installed in many different kinds of environment, even outside a real professional kitchen or when the cooking activity is done in front of the customers (or at least in the same room);

1-3 PICTURE OF THE APPLIANCE



2. List of required equipment for maintenance & repair

The following instruments and tools must be available for servicing the appliance additionally to the regular equipment:

- MW leakage detector suitable for UL requirements (sensitivity 0.1mW/cm2). => 0D6887
- Multimeter => 0S0479
- Torx screw drivers sizes 18, 20 and 25.
- Surface contact temperature probe (min 300°C/572F).

In case of repair the following materials may be necessary:

- Conductive paste (for min 280 °C) => 049196 (100gr)
- Silicone RTV 102 color white. => 0D6886
- Silicone RTV 108 color transparent. => 0D1250

- Acetona.
- Glue: Loctite (Strong version).
- Test load for MW leakage: 1 quart/1 liter of tap water in a high temperature and MW proof container . (Note the height of the container cannot be more than 3"/75mm).
- Specific Glass cutting device. => 0D6888
- Cutter.
- Tool for smoothening a silicon rod.
- Positioning Jig (only on demand for Authorized Repair Centres).

3. Check list for each intervention on the appliances

Important!



- Appliance installation and any maintenance work must be carried out only by specialized personnel authorized by the manufacturer. Microwave leakage must be checked every time you do service to the machine.

For the safe and efficient use of the appliance it is recommended to check at each intervention the following issues.

- General integrity and cleanliness of the appliance
- Microwave leakage
- Right Functioning of the appliance

The following check list can be used also as guideline for every preventive maintenance. Please refer to the after sales dealer policy for more information.

General integrity and cleanliness

Unplug the appliance!

Verify that the machine is cooled down!

As in any Microwave appliance, it can occur to have sparks inside the cooking chamber. These sparks do not influence the safety of the user nor the safety of the appliance nor the quality of the food. If, as a consequence of the sparking, a dark mark on the metal parts is visible, this can be cleaned with a damp cloth.

If it is necessary to train the user on the cleaning, refer to the cleaning instructions on pages 3 and 4 and chapter 5 in this handbook.

a) Check the location (see installation diagram in page 15)

- Distances to other machines, walls and combustible parts
- Obstacles for the opening and closing action
- Obstacles on vent holes of the appliance
- Overall cleanliness of the surroundings of the appliance
- Check the used tools for cleaning . If not OK, advise the user.

b) Check the mechanical condition of the appliance

Glass:

- Cracks of the glass.
- State of the silicone sealing around the glass.
- Good position of the insulating parts inside the launching chamber.
- Check the glass for heavy dirt.

Upper heating plate:

- Smooth movement of the upper heating plate, no noise.
- Easy removal of the upper heating plate.
- Check the presence and tightness of the screws of the cover of the upper heating plate.
- Check the state of the upper plate cable and the tightness of the connector to the column of the upper heating plate.
- Cleanliness of the upper cooking chamber.
- Easy plug-in of the upper heating plate with easily locking it
- Cleanliness of the upper heating plate, especially carbon deposits and damages of the coating.

Upper lid:

- Easy closing and opening of the lid, no noise and no unusual forces.
- Open the front cover and check the cleanliness of the steam evacuation chamber.

Remove all particles stuck the grid.

Handle:

- Easy movement of the handle. Limiter screw must be in place.
- Easy movement of the 2 pins in the handle and its automatic repositioning.
- Check the tightness of the 2 pin blockers.
- Easy movement of the electromagnet washer.
- Cleanliness of electromagnet washer.

Front of the appliance:

- Cleanliness of the electromagnet.
- Good and tight position of the flat panel (membrane).
- Check for a big gap between front panel and electro magnet support.
- Repair or renew the parts, if necessary.

Sides of the appliance

- No blocking of the ventilation holes.

Back of the appliance.

- No blocking of the exhaust holes.
- Check the silicone sealing on the top of the tilting box.

Cable connections (unplugged).

- Check the main power supply cord concerning damages, burnings etc.

Microwave leakage

Go to this test only if the above described "General integrity and cleanliness" test was passed!

Prepare and switch on your Microwave Detector (see "List of required instruments for maintenance & repair" in chapter 2 of this manual).

Press the two outer program buttons in the same time you plug in the machine until that you see P1 on the display. (This testing mode give the possibility to start the microwave cycle without waiting the end of the preheating mode).

Put the specified load (see  "List of required instruments for maintenance & repair" in chapter 2 of this manual) onto the glass and close the lid.

Start the leakage test immediately (the detector probe must be at 5cm from the tested part perpendicular to it, verify the position of your probe inside the detector):

- In front of the appliance horizontally along the gap between lid and front panel.
- On both sides of the appliance horizontally along the gap between lid and lateral covers.
- On the back of the appliance horizontally along the gap between lid and tilting box.
- On the top of the appliance all around the column and the upper plate cable.
- Inside the steam evacuation chamber (front cover removed!)



Warning: If the limit of 1.0 mW/cm² or 60V/m in the North America and 5,0 mW/cm² or 300V/m in Europe is exceeded for more than 3sec at the same position, the appliance has a microwave leakage and has to be stopped immediately. (see "Repair section" in chapter 5 of this manual).

Functioning of the appliance

As the appliance is still in the testing mode and might have not the right temperature, the appliance has to be switched off and disconnected from the power supply.

The functioning test has to be executed as follows:

Connection to power supply.

- Verify the version of the User Interface.

Switch on and preheating

- Switch on the appliance.
- Check the temperatures on the glass and on the upper heating plate.
- Try to push the program buttons (they should not be operational during preheating).

During operation mode

- Start a cycle with the defined load.
- Check correct lid latching.
- Check automatic lid opening.
- Check cooking results (grilling of top and bottom as well as core temperature in accordance with the chosen program if using real load.
- Check all other programs.

For all findings please refer to the "troubleshooting" or the "repair section" in chapter 4 resp. 5 in this manual.

4. HSG troubleshooting

For a fast and efficient, but also safe elimination of a potential problem with the appliance, the trained service personnel can use the following troubleshooting guide.

See the important safety information in Chapter 1 of this service manual before any intervention on the appliance.

The troubleshooting guide has been set up in such a way that the real cause behind the problem identified can be found by going through the troubleshooting guide step by step from the beginning.

Important!



- Appliance installation and any maintenance work must be carried out only by specialized personnel authorized by the manufacturer. Microwave leakage must be checked every time you do service to the machine.

Error codes

ERROR CODES	DESIGNATION
Err 1	Bottom probe
Err 2	Top probe
Err 3	Overheating HV transformer
Err 4	Front magnetron circuit problem
Err 5	Rear magnetron circuit problem
Err 6	Both magnetrons circuit problem

How to enter the Program mode

Unplug the machine. Plug the machine and simultaneously press buttons 2 and 3 to enter the program mode. (BASI for EU model and PRO for US model)

See the program mode diagram for the details.

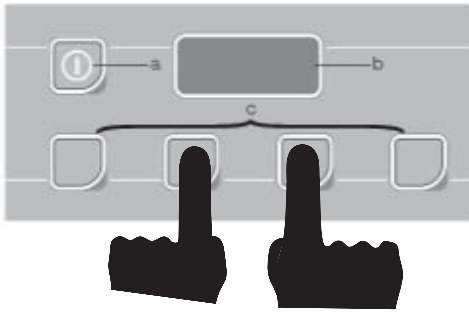

List of settings :

Temp: temperature in C° or F°.

trt : temperature of the upper heating plate

trb : temperature of the bottom plate

tCYx: times corresponding to cycle x (1 2 3/4 S)

tt : total time of the cycle

tw: time of micro wave during the cycle

Action on buttons :

A : enter in the setting

B : decrease the value of the setting

C : increase the value of the setting

D : skip to the following parameter

Explanation on software settings US Version (U202-U208)

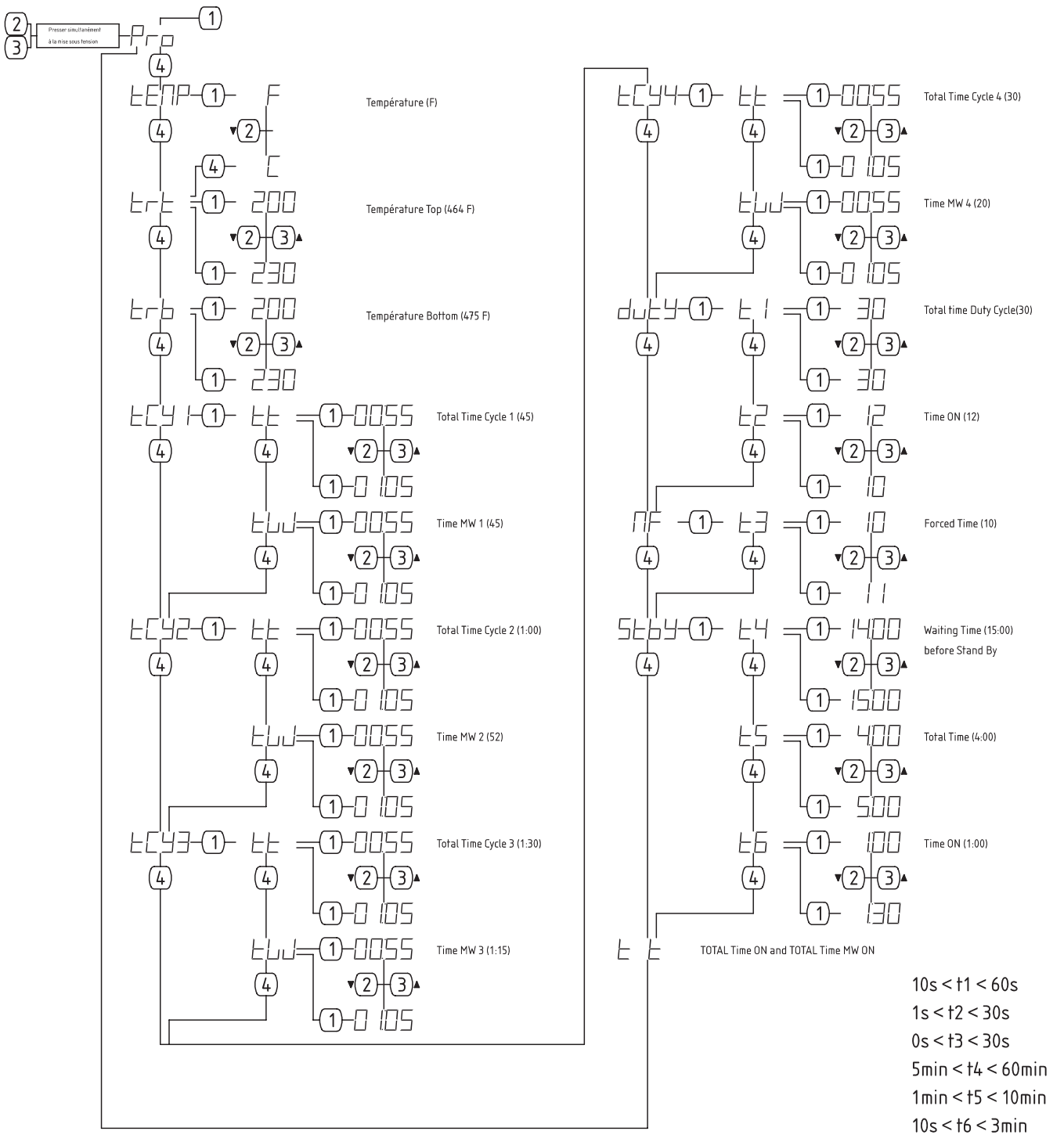

Settings Table For US Version U202

Since 09061 - Until 09122

	Parameters	Range	Default	New Parameters
Duty	t1	10s - 60s	30	
	t2	1s - 30s	12	
MF	t3	0s - 30 s	10	
Stby	t4	5 min - 60 min	60	
	t5	1 min - 10 min	240	
	t6	10s - 3 min	60	
Temp	trt	150°C - 250 °C / 300°F - 482°F	240°C / 464°F	
	trb	150°C - 280°C / 300°F - 536°F	246°C / 475°F	
Tcy1	tt	1s - 5 min	45	
	Tw	0s - 5 min	45	
Tcy2	tt	1s - 5 min	60	
	tW	0s - 5 min	52	
Tcy3	tt	1s - 5 min	90	
	tW	0s - 5 min	75	
Tcy4	tt	1s - 5 min	30	
	tW	0s - 5 min	20	

Settings Table For US Version U208

Since 09061

	Parameters	Range	Default	New Parameters
Duty	t1	10s - 60s	30	
	t2	1s - 30s	12	
MF	t3	0s - 30 s	0	
Stby	t4	5 min - 60 min	60	
	t5	1 min - 10 min	240	
	t6	10s - 3 min	60	
Temp	trt	150°C - 250 °C / 300°F - 482°F	240°C / 464°F	
	trb	150°C - 280°C / 300°F - 536°F	233°C / 451°F	
Tcy1	tt	1s - 5 min	45	
	Tw	0s - 5 min	45	
Tcy2	tt	1s - 5 min	60	
	tW	0s - 5 min	52	
Tcy3	tt	1s - 5 min	90	
	tW	0s - 5 min	75	
Tcy4	tt	1s - 5 min	30	
	tW	0s - 5 min	20	

Settings Table For EU Version U206 Since 09131 - Until 09191

	Parameters	Range	Default	New Parameters
Duty	t1	10s - 60s	30	
	t2	1s - 30s	12	
MF	t3	0s - 30 s	10	
Stby	t4	5 min - 60 min	60	
	t5	1 min - 10 min	240	
	t6	10s - 3 min	60	
Temp	trt	150°C - 250 °C / 300°F - 482°F	250	
	trb	150°C - 280°C / 300°F - 536°F	230	
Tcy1	tt	1s - 5 min	30	
	Tw	0s - 5 min	20	
Tcy2	tt	1s - 5 min	40	
	tW	0s - 5 min	30	
Tcy3	tt	1s - 5 min	50	
	tW	0s - 5 min	40	
Tcy4	tt	1s - 5 min	59	
	tW	0s - 5 min	0	

Settings Table For EU Version U207 Since 09131

	Parameters	Range	Default	New Parameters
Duty	t1	10s - 60s	30	
	t2	1s - 30s	12	
MF	t3	0s - 30 s	10	
Stby	t4	5 min - 60 min	60	
	t5	1 min - 10 min	240	
	t6	10s - 3 min	60	
Temp	trt	150°C - 250 °C / 300°F - 482°F	250	
	trb	150°C - 280°C / 300°F - 536°F	230	
Tcy1	tt	1s - 5 min	30	
	Tw	0s - 5 min	20	
Tcy2	tt	1s - 5 min	40	
	tW	0s - 5 min	30	
Tcy3	tt	1s - 5 min	50	
	tW	0s - 5 min	40	
Tcy4	tt	1s - 5 min	59	
	tW	0s - 5 min	0	

Comments : The modification between U206 and U207 concern only the display for the Program 4.
PS is now replace by P4

Parameters details HSG Panini

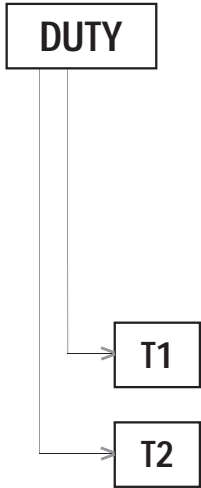

Regulation of the temperature of the bottom plate except during standard cycle (a cooking program is selected, the display shows Px, the upper lid is open, the machine is not in Std By).
The temperature regulation is not in this cycle managed by probe but by time (on/off).

⚠ The Upper Plate T° is regulated by a probe.
💡 info → the maxi temperature of cut of the probe is 250°C.

T1: Total time of a period in the duty cycle (in seconds).

T2: Time where the resistance of the bottom plate is switched on during the period T1 (in seconds).

- 💡 T2 = 12 with T1 = 30 → T° bottom ≈ 250°C / 482 F
- 💡 T2 = 11 with T1 = 30 → T° bottom ≈ 235°C / 455 F
- 💡 T2 = 10 with T1 = 30 → T° bottom ≈ 220°C / 428 F

Duty cycle chronogram :

Management of the temperature of the bottom plate except during the cooking cycle or Std By mode

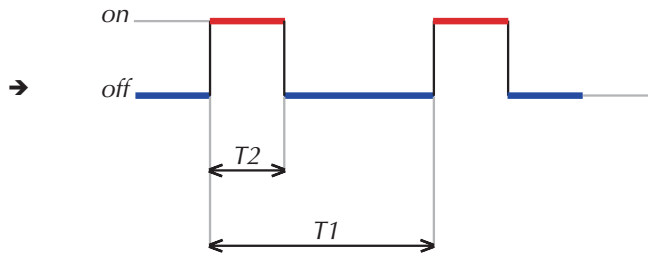

Forcing time
Time at the beginning of each cooking cycle during which the resistance of the bottom plate is in forced on time to decrease the impact of the temperature drop of the glass because of a panino being placed on it.

⚠ If too much high, risk of dark bottom of the panino.

T3: Time of forcing time (in seconds).

Std By

Energy save mode

Mode in which the machine can be set to decrease the electrical consumption. In this mode, the energy save mode is made by a control of temperature by time on/off of the lower resistance

T4

Time before Std By (in minutes)

T5

Total time of a Std By period (in minutes)

T6

Time where the bottom plate resistance is switched on during T5 (in minutes).

Std By cycle chronogram :

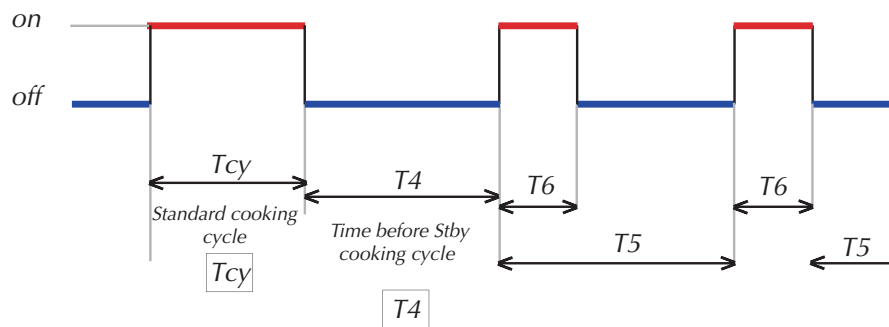

Temp

Temperature regulation of the lower and upper resistances

Trt

Temperature regulation of the resistance and the upper plate

Trb

Temperature regulation of the resistance and the lower plate

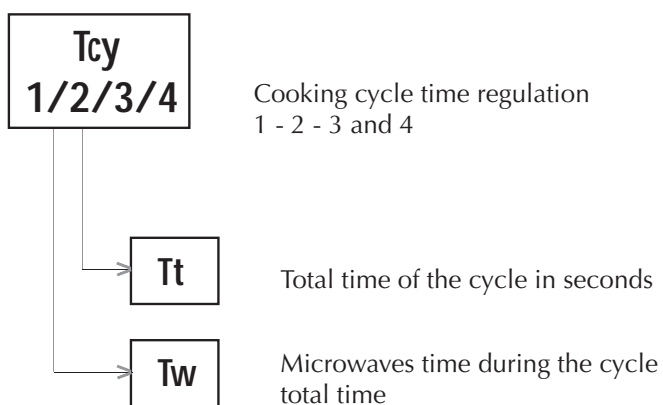

Tcy cycle chronogram :

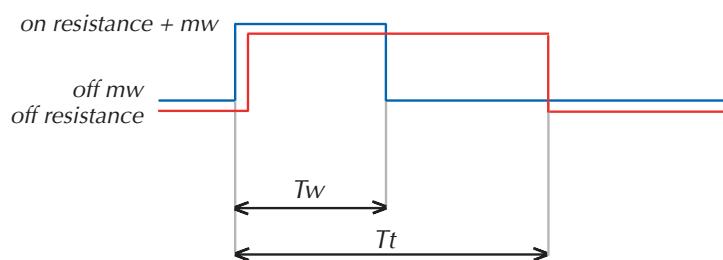

Problem		Check if ...	If not, action to do
The unit doesn't power up	<p>Yes</p> <p>no LED light on beside the ON/OFF switch button</p> <p>No</p>	Yes: Check ...	
		plug is inside the socket	plug in
		circuit breaker is on	re-engage
		voltage arrives to the outlet	problem not related to the unit
		voltage arrives to the terminal block : US version: 208V between L and N CE version: 400V between all phases and 230V between L3 and N on the filter	replace the cable and cord
		wires are hooked in the terminal block	fix the wires following the electrical diagram
		voltage is coming into the PCB with a voltmeter : 208V between 121 and 122 on the connector 12 on the board - CE version : 230V between 121 and 122 on the connector 12 on the board	reconnect or replace the cable if damaged
		the LED doesn't work	replace the board
	no initial display of "init" and "Ulxx"		replace the board
The unit doesn't go in preheating	<p>Yes</p> <p>On/off button is blocked (no «click»)</p> <p>No</p> <p>No preheating mode indication in the display</p> <p>Indicates Error Codes Err1</p> <p>Indicates Error Codes Err2</p>	Yes: Check ...	
		membrane is in place and not damaged	change the membrane
		button is not damaged	change board
		position between the board and the membrane is OK	reposition the board or the membrane
		KM1 is working by visually checking if the indicator moves from the initial position and the power coming in	reconnect the wires or replace the contactor
		the bottom probe is well connected	reconnect the probe
		The value of the resistance of the probe is approximately 1,1KOhm at room temperature (1,074 Kohm at 25°C/77°F)	replace the probe
		the top probe is well connected	reconnect the probe
		the wiring extension of the top plate probe is well connected	reconnect the wires
		The value of the resistance of the probe is approximately 1,1KOhm at room temperature (1,074 Kohm at 25°C/77°F)	replace the probe
The unit never reaches operating mode	<p>Yes</p> <p>The top plate temperature is not reaching the temperature setting</p> <p>No</p>	Yes: Check ...	
		cabling of the upper plate to the terminal block, is connected, check also connection between terminal block and power board => connector 5 on position 5 on the board + continuity test between terminal block and board	connect the wires in the good position on terminal block and on the board.
		the probe connector SUP is connected in position SUP on the board (lumberg black connector).	connect the connector SUP on the board

Problem		Check if ...	If not, action to do	
<p style="text-align: center;">No</p> <p style="text-align: center;">↓</p>	<p style="text-align: center;">No</p>	the top heating element is absorbing current with the Multimeter (approx. 4amps)	replace the upper plate kit	
		cabling between terminal block and the board (connector 5) is connected	connect the wires	
		the board is not giving power to the heating elements through the relay (voltmeter in connector 5 of the board, 208 V - 230V for CE version)	replace the board	
	The bottom plate temperature is not reaching the temperature setting	<p style="text-align: center;">No</p> <p style="text-align: center;">↓</p>	cabling of the bottom plate to the board, connector 4 is connected on position 4 on the power board.	connect the wires
	the probe connector INF is connected in position INF on the board (lumberg black connector.		Connect the connector INF on the board	
	the bottom heating element is absorbing current with the Multimeter (approx. 4amps)		replace the heating element of the bottom plate	
	the board is not giving power to the heating elements through the relay (voltmeter in connector 4 of the board)		replace the board	
<p>The lid doesn't latch</p> <p style="text-align: center;">No</p>	<p style="text-align: center;">Yes</p> <p style="text-align: center;">↓</p> <p style="text-align: center;">The lid never latch</p> <p style="text-align: center;">No</p>	<p>Yes: Check ...</p> <p style="text-align: center;">↓</p> <p>the handle reaches the right position to the electromagnet</p> <p>the electromagnet and/or the washer are dirty</p> <p>if the handle magnets are in place</p> <p>the handle pins are blocked</p> <p>screw of the washer is tight</p> <p>cables of the electromagnet and magnetic detectors are connected (Connector 10)</p> <p>electromagnet is working by a continuity test from the connector 10</p> <p>from connector 10 there is nominal voltage when closing the lid</p> <p>magnetic detectors are working by a continuity test from the connectors 14/15 (by closing the lid)</p> <p>the bimetallic sensors (CLK1 and CLK2) are working by a continuity test from the pins of the connector 3 (from the two left and the two right contacts)</p> <p>KS1 is working by visually checking if the indicator move from the initial position and the power coming in</p> <p>there is enough free clearance for the airflow from the exhaust pipes in the rear of the machine</p>	<p></p> <p>remove all obstacles and/or check for mechanical frictions</p> <p>make a proper cleaning</p> <p>replace the handle</p> <p>try to unblock or replace the handle</p> <p>readjust the latching system</p> <p>connect the wires</p> <p>change the electromagnet</p> <p>replace the board if the power supply is suitable</p> <p>readjust or change the magnetic detectors</p> <p>change the bimetallic sensor failed</p> <p>reconnect the wires or replace the contactor</p> <p>give the clearance according to the installation diagram</p>	

Problem		Check if ...	If not, action to do	
<p>No</p> <p>↓</p>	<p>No</p> <p>↓</p>	there is an airflow from the exhaust pipes in the rear of the machine	reconnect the exhaust pipes to the exhaust pipes support or remove possible clogging obstacles inside the pipes	
		the fan cabling is connected	reconnect the wires of the fan	
		there is power supply on both magnetron fans (connector 7 on the board - from the two left and the two right contacts)	replace the board	
		the magnetron fans are working with an ohmmeter	replace the broken fan	
<p>The lid doesn't open automatically at the end of the cycle</p> <p style="text-align: center;">No</p> <p style="text-align: center;">↓</p>	Yes	Yes: Check ...		
	the handle is moving	No	there is free movement by verifying: - the opening of the lid - no friction between lid and working top	assure free movement
	the handle is blocked		the handle pins are pushing out	try to unblock or replace the handle
			lid springs are lifting the lid	adjust the spring tension or replace them if broken
			there is free movement between handle and the lid	assure free movement
			electromagnet is releasing the handle at the end of the cycle	replace the board
<p>Panino doesn't reach the desired core temperature</p> <p style="text-align: center;">No</p> <p style="text-align: center;">↓</p>	Yes	Yes: Check ...		
	No Error codes	No	the right program was chosen	use the right one
			the programs have the right parameters	set the right parameters
	Indicates Error Codes Err4 or Err5		high voltage wiring from the secondary of transformer are well connected and not damaged	reconnect them or replace if damaged
			the magnetron fuses are working	replace them
			capacitors are undamaged	replace it
			diode and resistor are undamaged	replace them
		Result: Magnetron is broken	replace following the error code	
	Indicates Error Codes Err6		The voltage to inlet is at least 1956V for 208V machine and 367V for a 400V machine.	problem not related to the unit
			the three phases are correctly connected in the main plug. (for EU machines)	Connect the wires to have three phases + neutral.
		If the fuse FS of the board is OK.	replace the fuse FS with the spare part fuse on the board and before restart the machine check the adjustment of Microswitch S3. => Follow the process indicated in the repair section	
		screw of the washer is tight	readjust the latching system	
		if the handle magnets are in place	replace the handle	

Problem		Check if ...	If not, action to do	
<p style="text-align: center;">↓</p>	<p style="text-align: center;">↓</p>	magnetic detectors are working by a continuity test from the connectors 14/15 (by closing the lid)	readjust or change the magnetic detectors	
		KS2 is working by visually checking the light on when starting a cycle	reconnect the wires or replace the static relay	
		switch breaker of the primary transformer is on	reactivate it	
		if both magnetrons are working like described in Err4or5	proceed like described under Err4or5	
<p>Panino is not grilled on the bottom as desired</p> <p style="text-align: center;">↓</p> <p style="text-align: center;">No</p>	<p>Yes</p> <p>Panini has no marks on the bottom</p> <p style="text-align: center;">↓</p> <p style="text-align: center;">No</p>	<p>Yes: Check ...</p> <p style="text-align: center;">↓</p> <p>The bottom resistor is working («orange color»)</p> <p>the programs have the right parameters</p> <p>the resistor wiring is connected and not damaged</p> <p>The value of the resistance of the probe is approximately 1,1KOhm at room temperature (1,074 Kohm at 25°C/77°F)</p> <p>the board contact of connector 4 are supplying the right voltage : 208V for US version and 230V for CE version</p> <p>the probe is well in contact with the glass</p>	<p></p> <p>proceed</p> <p>set the right parameters see the brief cooking result trouble shooting</p> <p>reconnect or replace if damaged</p> <p>replace the probe</p> <p>replace the board</p> <p>recondition/deblock the spring system that hold the temperature probe</p>	
	<p>Panini is overcooked on the bottom</p> <p style="text-align: center;">↓</p>	<p>the bottom surface is cleaned (no carbon deposits)</p> <p>the right program was chosen</p> <p>the programs have the right parameters</p> <p>The value of the resistance of the probe is approximately 1,1KOhm at room temperature (1,074 Kohm at 25°C/77°F)</p>	<p>clean it</p> <p>use the right one see the brief cooking result trouble shooting</p> <p>set the right parameters</p> <p>replace the probe</p>	
	<p>Panino is not grill on the top as desired</p> <p style="text-align: center;">↓</p> <p style="text-align: center;">No</p>	<p>Yes</p> <p>The Panino has no marks on the top</p> <p style="text-align: center;">↓</p> <p style="text-align: center;">No</p>	<p>Yes: Check ...</p> <p style="text-align: center;">↓</p> <p>the upper plate can adjust to the Panino automatically (free movement)</p> <p>The upper plate is working (measure temperature)</p> <p>the programs have the right parameters concerning temperature</p>	<p></p> <p>deblock the upper plate by cleaning and/or repairing</p> <p>proceed</p> <p>set the right parameters see the brief cooking result trouble shooting</p>

Problem		Check if ...	If not, action to do				
↓		the resistor wiring 51 and 52 is connected and not damaged (resistor to terminal block and terminal block to board)	reconnect or replace if damaged				
		The value of the resistance of the probe is approximately 1,1KOhm at room temperature (1,074 Kohm at 25°C/77°F)	replace the probe				
		the top heating element is absorbing current with the Multimeter (approx. 4amps)	replace it				
		the board is providing the right voltage : 208V for US version and 230V for CE version	replace it				
	↓	Panini is overcooked on the top	the top surface is cleaned (no carbon deposits)	clean it			
			the right program was chosen	use the right one			
			the programs have the right parameters	set the right parameters see the brief cooking result trouble shooting			
			The value of the resistance of the probe is approximately 1,1KOhm at room temperature (1,074 Kohm at 25°C/77°F)	replace the probe			
↓	No	Panino sticks to the upper plate	Yes	Yes: Check ...			
			↓	The Panino is partially or completely sticking to the upper plate	No	the upper plate or the used baking paper is clean	clean it
						the upper plate or the used baking paper is damaged	replace the baking paper or if necessary the total upper plate kit
						the programs have the right parameters (T<250°C)	set the right parameters see the brief cooking result trouble shooting
						the load (Panino) is appropriate to the HSG	avoid this type of load
↓	No	The panino is too much pressed	Yes	Yes: Check ...			
			↓	The Panino too much pressed	No	the upper plate can adjust to the Panino automatically (free movement)	deblock the upper plate by cleaning and/or repairing
						the Panino was placed correctly in the work zone	train the user
						the programs have the right parameters (time of MW)	set the right parameters
						the load (Panino) is appropriate to the HSG	avoid this type of load
↓	No	The upper plate is not removable for cleaning	Yes	Yes: Check ...			
			↓	Upper plate not releasable	No	the release pin is blocked, so no pushing possible	unblock the release pin
						the release pin can not be pushed enough to release the plate	readjust or replace the release system

Problem		Check if ...	If not, action to do
↓	Upper plate releasable, but not removable completely from the cooking chamber ↓	there are obstacles for a free movement	deblock the upper plate by cleaning and/or repairing
		the upper plate cable is free to enter into the cooking chamber	deblock it or help manually to enter
The panino is soggy and/or too much condensation around the working top ↓ No ↓	Yes ↓ Soggy or condensation ↓ No ↓	Yes: Check ... ↓	
		the ventilation grid in the front of the lid is not clogged	clean it
		the steam outlet is free	deblock or clean it
		the programs have the right parameters	set the right parameters
		the load (Panino) is appropriate to the HSG	avoid this type of load
Visible mechanical damage ↓ No ↓	Yes ↓ Damages on the external parts of the lid ↓ No ↓ Damages on the internal parts of the lid (choke cover, choke, flat surfaces) ↓ Damages on the working top ↓ Damages of the glass ↓ Damages of the upper plate ↓ Damages on the external parts of the body	Yes: Check ... ↓	
		the damage does not influence MW leakage and mechanically the use of the machine (free movement of the upper plate, of the handle, upper plate cable etc.)	Repair or change the incriminated parts.
		choke cover pins are all in place	add the missing ones
		sealing of the choke cover is in good condition	reseal where needed
		choke cover is in place and without damages	Replace the choke cover. Verify the choke for bendings/damages. Readjust the strips of the chokes. If not possible replace the total lid.
		all the surroundings of the choke cover are without damage	check for microwave leakage or mechanical influences. Repair or replace the lid if necessary
		the working top is without damage	check for MW leakage or mechanical influences. Repair or replace the working top if necessary
		the silicone rod is not damaged or/and there is moisture below the glass	replace the silicone
		the glass is without damage or scratches	replace the glass
		the coating is not damaged	replace the total upper plate kit
upper plate cover is in place and/or damaged	fix it or change if necessary		
front panel and/or membrane are correctly in place (no possible water reaching internal parts of the machine)	replace the membrane or change the total front panel if necessary		

Problem		Check if ...	If not, action to do
↓	↓	louvers are not clogged or deformed	clean or change the part if necessary
Abnormal noise ↓ No ↓	Yes ↓	Yes: Check ... ↓	
	Noise during opening/closing the lid	lid springs don't make noise in movement	put some grease or cooking oil
	Noise permanent when machine is on	transformer fan is free rotating	remove the obstacles, readjust the position of the fan or replace it if broken
		magnetron fans are free rotating	remove the obstacles, readjust the position of the fan or replace it if broken
The machine goes in preheating/cooling frequently ↓ No ↓	Yes ↓	Yes: Check ... ↓	
	the phenomenon raises after a stdby mode or switching on of the machine	the the stdby parameter is according customer expectation	adjust it
	the phenomenon raises suddenly during operation	there is enough free clearance on the lateral sides for the cooling airflow	give the clearance according to the installation diagram
		there is an air suction flow on the right lateral side	clean the louvers
	the unit also displays err3	the fan is working	reconnect the wires of the fan or replace the fan
		there is enough free clearance on the lateral sides for the cooling airflow	give the clearance according to the installation diagram
		there is an air suction flow on the right lateral side	clean the louvers
Automatic lid opening doesn't work properly ↓ No ↓	Yes ↓	Yes: Check ... ↓	
	lid doesn't arrive or stay in full open position	the lid has a free movement	remove the obstacle
	↓	springs are both in place and not broken and well adjusted	adjust or replace them
		gas spring is in place	adjust or replace it
		spring support is not broken	replace it
		axis is not broken and not deformed	replace it
		tube is not broken and not deformed	replace it
		the bushings are not broken and are in place	adjust or replace it
		screws of the tube axis are tightened	tighten them
		lid opens too fast	springs are both well adjusted
Error 4 or 5 is indicated, but the Panino reaches the desired core temperature	the amperometric transformer is working by measuring the Voltage on connector TM (approx. 3V)	replace it	

4-1 COOKING RESULT TROUBLE SHOOTING

QUALITY COOKING OF THE SANDWICH

If the sandwich is not enough or too much cooked try another program.

If there is no adequate program follow the trouble shooting here above:

FINDINGS	WHAT TO DO	
The core temperature of the sandwich is too cold	- Increase the time of microwave (tw) - If the time of microwave tw is more than the total time (tt), increase also the total time (tt).	
The core temperature of the sandwich is too hot	Decrease the time of microwave (tw)	
The top of the sandwich is burned	Decrease the upper heating plate temperature (trt) and (or) decrease the total time (tt).	warning : - the temperature of the upper heating plate is the same for the 4 programs. - the temperature of the bottom glass is the same for the 4 programs.
The top of the sandwich is not enough cooked	Increase the upper heating plate temperature (trt) and (or) increase the total time (tt).	
The bottom of the sandwich is burned	Decrease the bottom glass temperature (trb) and (or) decrease the total time (tt).	
The bottom of the sandwich is not enough cooked	Increase the bottom glass temperature (trb) and (or) increase the total time (tt).	

5. Repair section

Important!



Appliance installation and any maintenance work must be carried out only by specialized personnel authorized by the manufacturer. Microwave leakage must be checked every time you do service to the machine.

In this chapter you will find the description of the necessary work to do in case the appliance has to be repaired. Please refer to the after sales dealer policy for more information on the repairing activities.

Make sure to follow all general safety instructions concerning repairing electrical appliances.

Make sure to follow all specific safety instruction concerning this appliance (see Chapter 1.1 of this manual).

There are 2 ways to access the internal parts of the appliance: by dismantling the bottom plate and by dismantling the back panel of the tilting box.

In any case, do not open the appliance in total, i.e removing both side panels at the same time. In doing so, all adjustments of the appliance will be lost and the appliance is unusable. Only the specific Authorized Repair Centres are able to make proper adjustments with special tools.

Make sure to access the machine using the right way, which is indicated in the following descriptions.

5-1 CHANGE THE PROBE OF THE BOTTOM RESISTOR

This is not possible by every technician! Only in Authorized Repair Centres.

Switch off and disconnect the machine.

Unscrew the tilting box with the lid (item S30 articulation exploded view and 47 in cover exploded view).

Return the appliance on its back and position it in the jig.

Remove the bottom plate (Item 27 on the housing exploded view).

Remove the front panel (Item S11 on the housing exploded view).

Remove the two lateral sides (Items 20 and 22 on the housing exploded view).

Disengage the two springs (Item 4 on the Launching Chamber exploded view).

Remove the washers and the cylindrical spring (Items 5 and 6 on Launching Chamber exploded view).

Remove the launching chamber (item 9 launching chamber exploded view).

Disconnect the probe cable in the board.

Take out the probe and replace with a new one.

Reassemble the appliance.

Warning! Remember to position and fix the tilting box with the core part of the appliance still in the jig (this will keep the correct position between the lid and the working top).

5-2 REPLACE THE TOTAL UPPER PLATE KIT

Switch off and disconnect the machine.

Open the back panel of the tilting box (items 100 and 101 on articulation exploded view).

Disconnect the 3 wires (small terminal block and the Lumberg connector of the probe).

Unscrew and remove from the tilting box the upper plate cable (item 40 on the cover exploded view) connector (item 98 on articulation exploded view).

- Put a protection (e.g. clothes, silicon liner) on the glass surface.
- Hold the lid down with one hand and unlock the upper heating plate by pushing the button (item 41 on the cover exploded view).
- Open the lid carefully and take care that the upper heating plate removes out of the cooking chamber (in final position the upper heating plate stands on the glass).

Remove the complet upper plate kit including upper plate cable (item S21 on the cover exploded view).

Assemble the new upper plate kit :

Put the upper plate cable in the hole (item S24 cover exploded view)

- Check the position of the upper heating plate: FRONT symbol to front and remount the upper heating plate by pushing the column into the central guidance until the locking mecanism is locked (CLICK sound).

- Move up and down the upper heating plate to check the correct functioning.

Reconnect the upper plate cable connector on the tilting box.

Rconnect the 5 wires.

Check the correct functioning by measuring the right T°.

Assemble the back panel of the tilting box.

Replace the machine in accordance with the installation diagram.

5-3 REPLACE THE HEATING ELEMENT OF THE BOTTOM PLATE

Switch off and disconnect the machine.

Remove the glass (Item 1 on the working top exploded view) by cutting the silicone seal with the glass cutting device (see list of required tools).

Remove the front panel (items 28 and 30 in the housing exploded view).

Remove the electromagnet support (Item 33 on the housing exploded view) by unscrewing the 2 screws and the 2 nuts.

Disconnect the 2 wires connected to the resistor .

Unscrew the 2 nuts of the resistor.

Remove the resistor through the opened working top (glass removed). Pay attention not to damage the other internal parts like the probe tube and the probe!

Put in place the new resistor and fix it in using the 2 new nuts

Connect the 2 wires disconnected before.

Replace the electromagnet support and the front panel.

Pay attention that all wires are still well connected.

Put in the glass following the instructions written in chapter 5-7 (Replace the glass).

5-4 READJUST THE LATCHING SYSTEM

Remove the black cap on the handle, and unscrew the nut.

Unscrew completely the screw in the washer (item 58 of the lid exploded view)

Check if the seal (item 59 of the lid exploded view) is in place and in a good position. If not , place correctly or change it.

Screw the screw until that is in contact with the handle, then make a half turn back.

Check if the latching system is working correctly. Pay attention that

tha appliance has to be either in operation or in testing mode.

If not reajust the screw of the washer (in small steps screw or unscrew)

Check again and repeat if necessary until find the correct position.

Maintain the screw with a screw driver and in the same time block the opposite nut.

Put in place the black cap.

5-5 READJUST OR CHANGE THE MAGNETIC DETECTORS

Switch off and disconnect the machine.

Make sure that the detector that has not passed the continuity test is in the right position and correctly tight.



(see the following picture to determine the correct position).

If not: reposition it or tighten it.

If yes: replace it.

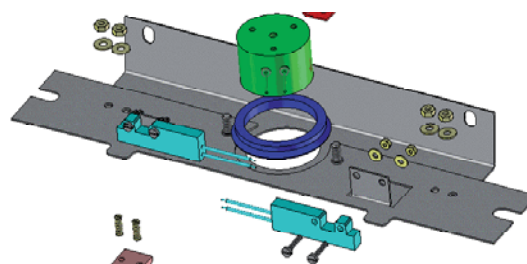

5-6 REPAIR OR REPLACE THE CHOKE COVER.

Switch off and disconnect the machine.

If the choke cover is damaged, it must be replaced. Therefore:

- take out all choke cover pins by using a screw driver.
- cut the silicone sealing with a cutter (see list of required tools).
- remove the choke cover.
- clean all the contact surfaces with Acetone (see list of required tools).
- Verify that the choke is in good condition (no bendings, damages).
- Readjust the strips of the choke, if necessary. If not possible, replace the entire lid!
- Put the new choke cover on the choke.
- Press in all choke cover pins (Make sure to use the new pins delivered with the choke cover).
- Seal the choke cover with a silicone rod and smoothen it with the specific tool (see list of required tools).

- The concerned parts must not be touched and the appliance must not be used for at least 8hours.

If one or more choke cover pins are missing:

- Replace the missing pins by new ones.

If the silicone rod of the choke cover is damaged or no more complete:

- Clean the concerned area from old silicone rests by using a cutter (see list of required tools).
- Clean all the contact surfaces with Acetone or regular primer for RTV (see list of required tools).
- Renew the silicone sealing and smoothen it with the specific tool (see list of required tools).
- The concerned parts must not be touched and the appliance must not be used for at least 8hours .

5-7 REPLACE THE GLASS

Switch off and disconnect the machine.

If the glass is still in one piece:

Remove the glass (Item 1 on the working top exploded view) by cutting the silicone seal with the glass cutting device (see list of required tools in this manual)

If the glass is broken:

Remove the pieces carefully by using gloves to avoid cuttings of the hand.

Remove all rest of silicone sealing on the working top.

Degrease the contact area of the working top with Acetone (see list of required tools in this manual).

Place the new glass (item 1 on launching chamber exploded view) on the working top.

Seal the glass with a sealing rod between the glass and the working top (be careful to fill the entire gap also underneath the glass). Use the specific tool to smooth the silicon rod.

5-8 ADJUST THE SPRINGS (See page 23)

Switch off and disconnect the machine.

Open the back panel of the tilting box (items100 and 101 on articulation exploded view).

Disengage the gas spring (item 88 on articulation exploded view) on one of its ends.



Adjust the springs (item 86 on articulation exploded view) in the way that their pretension lifts the lid 130mm +/- 10mm (5,1" +/-0,4") on the front without the gas spring working.

Reengage the gas spring.

Make a functioning test of the lid opening.

Reinstall the back panel of the tilting box.

(See page 23)

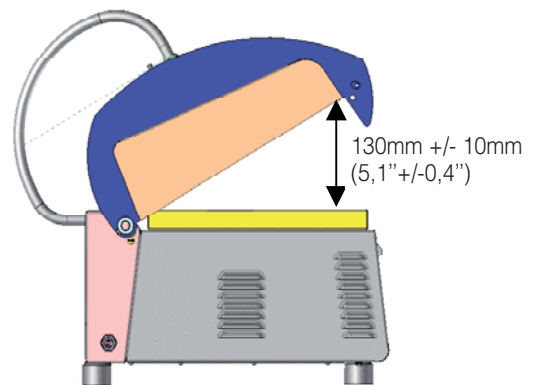

5.9 CHANGE THE GAZ SPRING (see page 26)

ADJUST THE SPRINGS :

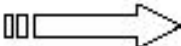
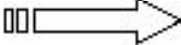

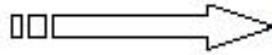

6

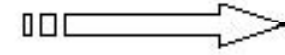
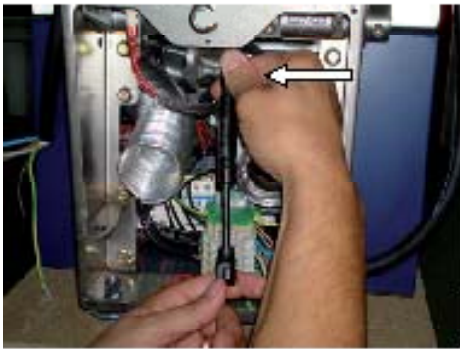
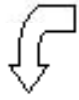

8

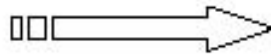

10

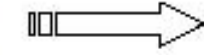

12

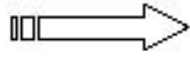

5.9 CHANGE THE GAS SPRING



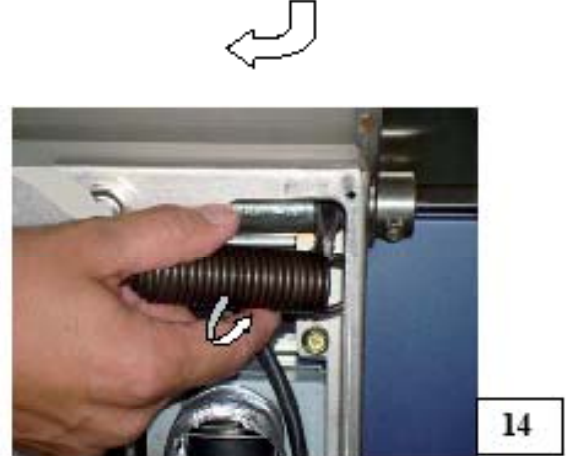
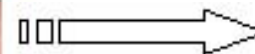
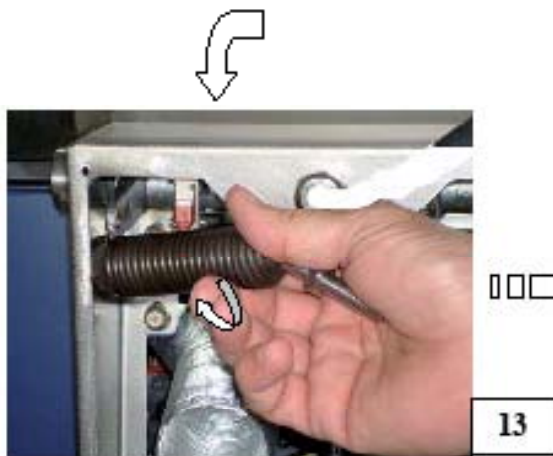
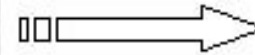
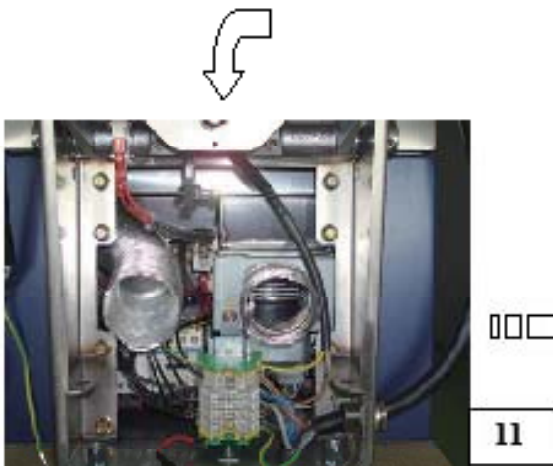
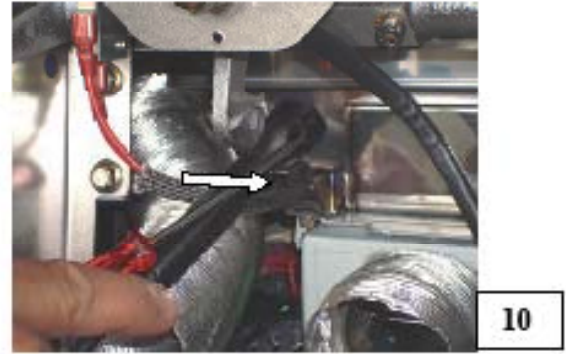
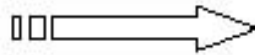
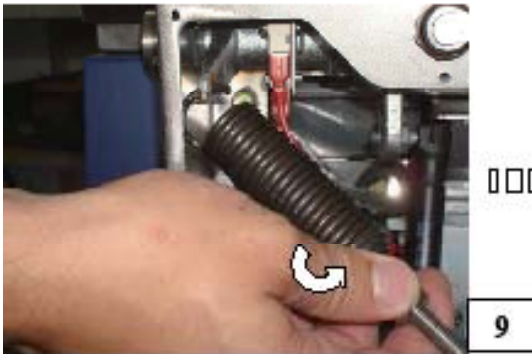
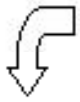
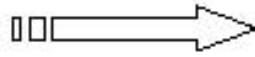



15

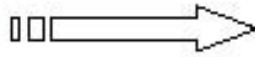

16



17

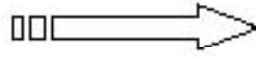

18



19

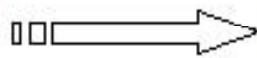

20



5-10 ADJUST THE MICROSWITCH S3 :

Adjustment of the micro switch S3

Composition of the kit 0D7003 :

- 1 micro switch support
- 4 washers M4
- 2 screws M4

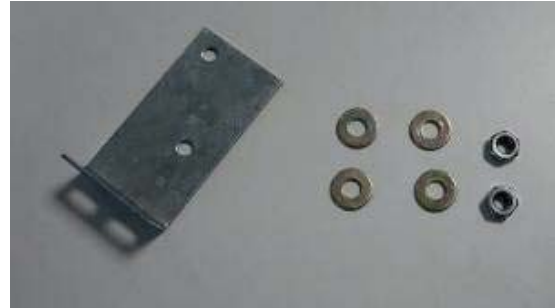

List of tools necessary to repair



- Screwdriver with Torx T20 socket
- Ratchet handle with M 7 socket
- Screwdriver for M3
- Wrench 7mm or socket 7mm
- Multi meter with a BIP function for continuity and 2 holders
- Adhesive tape
- Steel Rule or equivalent

Procedure: (Time of repairing 30 min)

- **1 Remove the rear cover**
(Screwdriver with Torx T20 socket)



- **2 Move the machine on the right side**



- **3 Disconnect the micro switch**



- **4 Remove the Micro switch support**
(Ratchet handle with M 7 socket)



- **5** Remove the micro switch and mount it on the new support .

This operation is mandatory

(Screwdriver for M3 and
Wrench 7mm or socket 7mm)



- **6** Mount 2 washers M4 on the welded screws of the tilting box

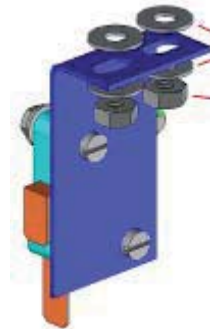

- **7** Mount the micro switch support
The wheel must touch the aluminium axis
Mount 2 washers M4
Mount the 2 nuts **delivered in the kit**
Tighten the nuts by hand



- **8** Move the machine upward and put an adhesive tape in order to maintain a gap of 16cm (6.1/4 inch) between the front of the cover and the top cooking surface

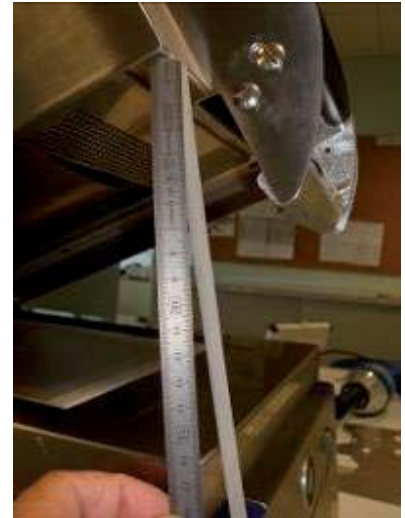

- **9** connect the multi meter on the micro switch and select the BIP continuity function



- **10** Adjust the micro by pushing it slowly in direction of the aluminium axis until the BIP stops

Tighten the nuts (Ratchet handle with M 7 socket)



- **11** Remove the adhesive tape and check with the multi meter that the Micro switch OFF (no beep) when the cover is between the close position and a gap of at least 12 cm (4.3/4 inch) up to 17cm (6.3/4 inch).

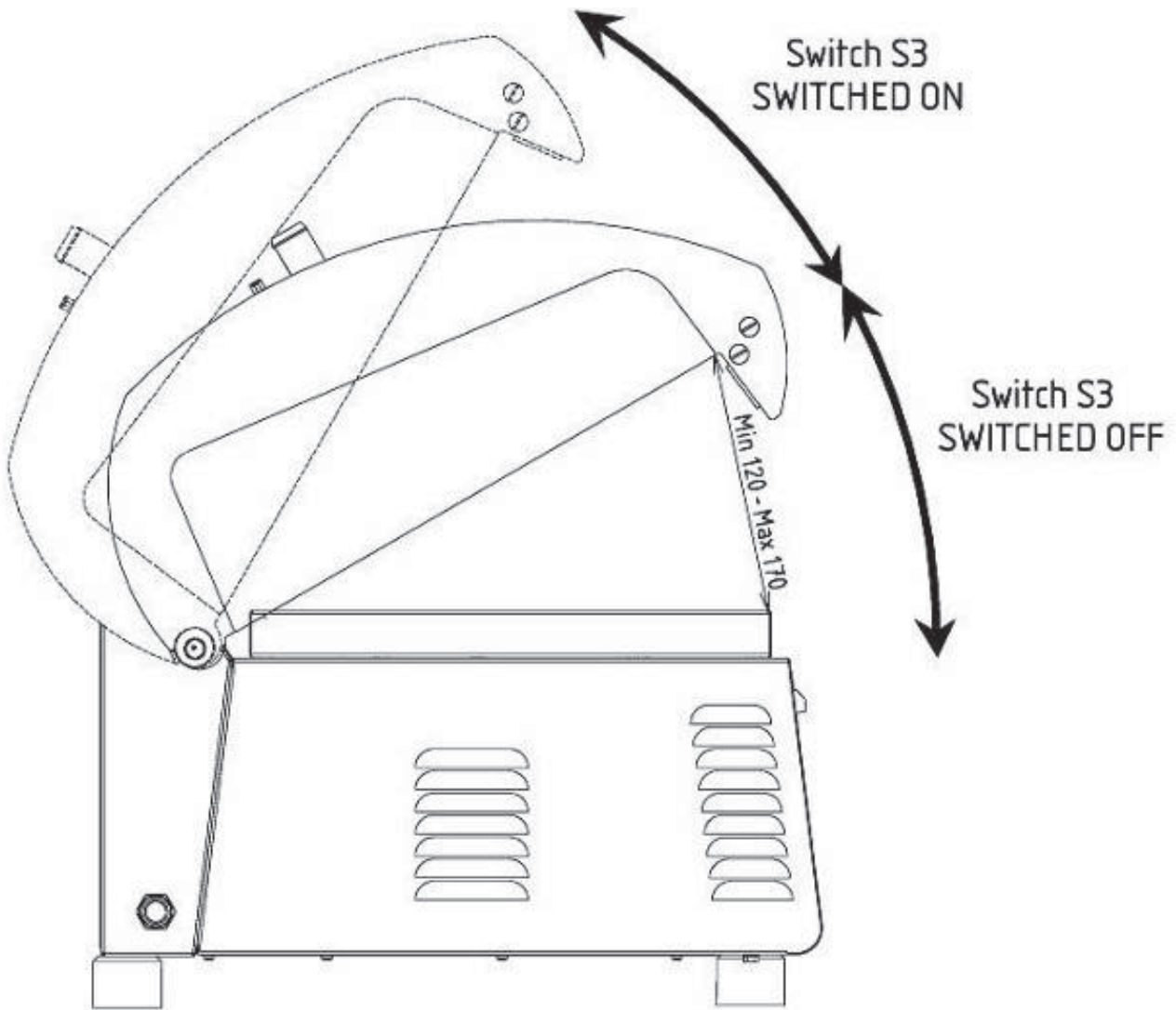

- 12 Check visually the position of the micro switch wheel to be sure that the wheel is all time align with the cam on the aluminium tube. Check this with cover in open position, in close position.

Cover closed

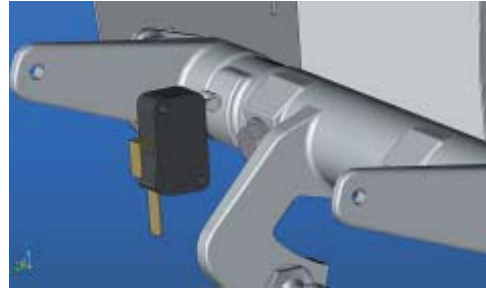
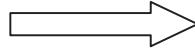
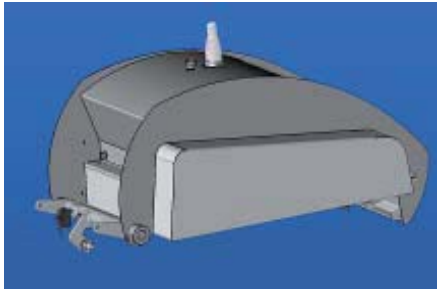

Cover open

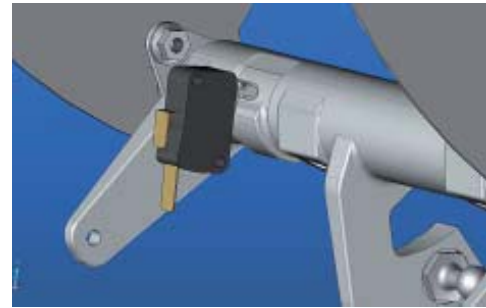
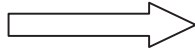
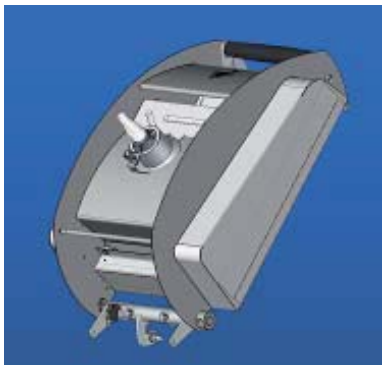

- 13 Connect the multi meter on the micro switch and select the BIP continuity function.



- 14 Close the cover and make pressure on the handle, in same time listen and check the multi meter to verify if in this position the micro switch stay open circuit. (no beep)



connect the micro switch.

mount the rear cover.

run the unit 4 cycles minimum (warning : made the test only with load).

the standard procedure of check list after each intervention :

b) Check the mechanical condition of the appliance

Glass:

- Cracks of the glass.
- State of the silicone sealing around the glass.
- Good position of the insulating parts inside the launching chamber.
- Check the glass for heavy dirt.

Upper heating plate:

- Smooth movement of the upper heating plate, no noise.
- Easy removal of the upper heating plate.
- Check the presence and tightness of the screws of the cover of the upper heating plate.
- Check the state of the upper plate cable and the tightness of the connector to the column of the upper heating plate.
- Cleanliness of the upper cooking chamber.
- Easy plug-in of the upper heating plate with easily locking it
- Cleanliness of the upper heating plate, especially carbon deposits and damages of the coating.

Upper lid:

- Easy closing and opening of the lid, no noise and no unusual forces.
- Open the front cover and check the cleanliness of the steam evacuation chamber.

Remove all particles stuck the grid.

Handle:

- Easy movement of the handle. Limiter screw must be in place.
- Easy movement of the 2 pins in the handle and its automatic repositioning.
- Check the tightness of the 2 pin blockers.
- Easy movement of the electromagnet washer.
- Cleanliness of electromagnet washer.

Front of the appliance:

- Cleanliness of the electromagnet.
- Good and tight position of the flat panel (membrane).
- Check for a big gap between front panel and electro magnet support.
- Repair or renew the parts, if necessary.

Sides of the appliance

- No blocking of the ventilation holes.

Back of the appliance.

- No blocking of the exhaust holes.
- Check the silicone sealing on the top of the tilting box.

Cable connections (unplugged).

- Check the main power supply cord concerning damages, burnings etc.

Microwave leakage

Go to this test only if the above described "General integrity and cleanliness" test was passed!

Prepare and switch on your Microwave Detector (see "List of required instruments for maintenance & repair" in chapter 2 of this manual).

Press the two outer program buttons in the same time you plug in the machine until that you see P1 on the display. (This testing mode give the possibility to start the microwave cycle without waiting the end of the preheating mode).

Put the specified load (see  "List of required instruments for maintenance & repair" in chapter 2 of this manual) onto the glass and close the lid.

Start the leakage test immediately (the detector probe must be at 5cm from the tested part perpendicular to it, verify the position of your probe inside the detector):

- In front of the appliance horizontally along the gap between lid and front panel.
- On both sides of the appliance horizontally along the gap between lid and lateral covers.
- On the back of the appliance horizontally along the gap between lid and tilting box.
- On the top of the appliance all around the column and the upper plate cable.
- Inside the steam evacuation chamber (front cover removed!)

 **Warning:** If the limit of 1.0 mW/cm² or 60V/m in the North America and 5,0 mW/cm² or 300V/m in Europe is exceeded for more than 3sec at the same position, the appliance has a microwave leakage and has to be stopped immediately. (see "Repair section" in chapter 5 of this manual).

Functioning of the appliance

As the appliance is still in the testing mode and might have not the right temperature, the appliance has to be switched off and disconnected from the power supply.

The functioning test has to be executed as follows:

Connection to power supply.

- Verify the version of the User Interface.

Switch on and preheating

- Switch on the appliance.
- Check the temperatures on the glass and on the upper heating plate.
- Try to push the program buttons (they should not be operational during preheating).

During operation mode

- Start a cycle with the defined load.
- Check correct lid latching.
- Check automatic lid opening.
- Check cooking results (grilling of top and bottom as well as core temperature in accordance with the chosen program if using real load.
- Check all other programs.

5-11 WIRES POSITION :

To don't have disturbance in the cabling, respect the position of the wires like on the following picture.

