

User Guide

Thank you for purchasing a SKOPE refrigeration product.

Safety

Always observe safety precautions when using any electrical appliance. Read these instructions carefully and retain them for future reference.

WARNING

- Ensure the appliance is disconnected from the power supply before performing any cleaning or maintenance.
 - Do not cover the grilles or block the entry or exhaust of airflow by placing objects up against the refrigeration unit.
 - Should manual defrosting be necessary, turn off the refrigeration system and allow the ice to melt by air circulation. Do not use mechanical methods to remove ice, as this may damage the refrigeration circuit.
 - Do not use any electrical devices or appliances inside the food storage compartment.
-
- Do not use this appliance for other than its intended use.
 - Do not probe any opening.
 - Only use this appliance with the voltage specified on the cabinet rating label.
 - Ensure the appliance has adequate ventilation as this is essential to economical, high performance.
 - Be careful not to touch internal moving parts and hot surfaces.
 - For your own safety and that of others, ensure that all electrical work is done by authorised personnel.
 - If the power supply flexible cord becomes damaged, it must be replaced by an authorised service agent or similarly qualified person in order to avoid a hazard.
 - Ensure all necessary safety precautions are observed during installation or removal of the refrigeration unit.
 - The appliance is not designed to be stable while in motion. Use extreme caution when moving or transporting it.
 - Do not store explosive substances such as aerosol cans with a flammable propellant in this appliance.
 - Do not exceed a maximum load of 20kg per shelf.
 - If the cabinet is to be scrapped, ensure the cabinet is unplugged from the power supply and cut off the mains flex close to the back of the cabinet. Be mindful of the risk of animals or children becoming trapped in the appliance - either remove or secure doors if necessary.
 - Refrigerant must be removed by a qualified service person and the cabinet recycled/disposed of in accordance with local regulations.

This cabinet is designed to operate within a specific climatic class environment. See the cabinet rating label inside the cabinet for climate class number.

Climate class	Ambient temperature	Relative humidity
3	25°C	60%
4	30°C	55%
5	40°C	40%
7 (tropical)	35°C	75%

The cabinet includes relevant hazard symbols that may be associated with the cooler. Refer to the information below for symbol description.



WARNING

The refrigeration system contains flammable R290 refrigerant. Do not tamper with it.

The refrigeration system must only be serviced by qualified personnel.

Installation Guidelines

When installing this fridge, ensure the installation guidelines below are considered and met.

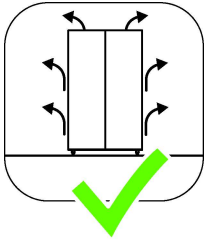

Ventilation

Ensure all ventilation requirements below are met.

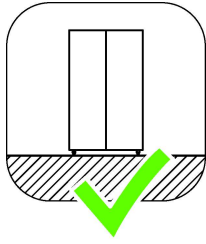

Surface

The installation surface must be capable of supporting the loaded cabinet.

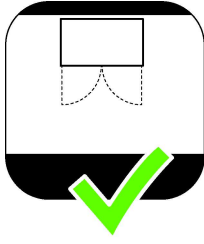

Door Opening

Allow adequate space for the door/s to open and close properly.

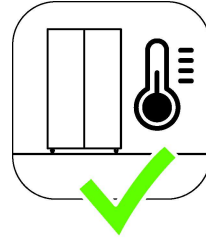

Climate Class

The fridge must be installed in an environment within its climate class.

The climate class is stated on the cabinet rating label inside the fridge, and explained on the front page of this user guide.

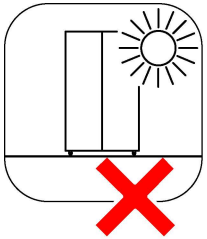

Sunlight

Do not install the fridge in direct sunlight.

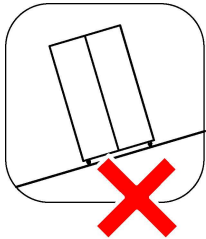

Uneven Surface

Do not install the fridge on an uneven surface.

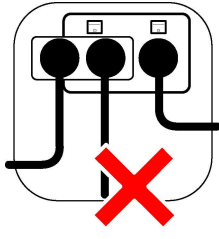

Power Supply

Do not overload the power supply.

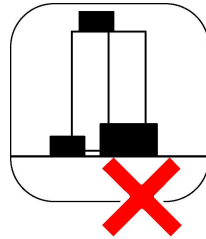

Blocking Ventilation

Do not store boxes or items in front or on top of the fridge.

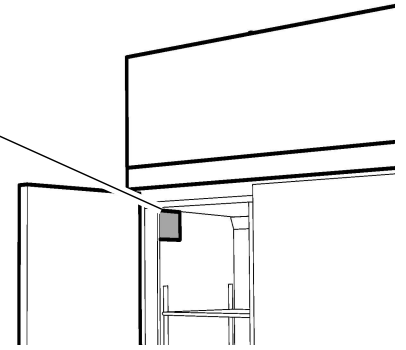

Ventilation Requirements

This fridge must have the following ventilation clearances at all times.

TME and SKT models

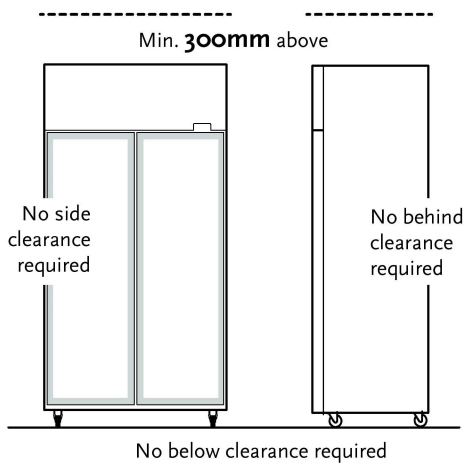

BME and SKB models

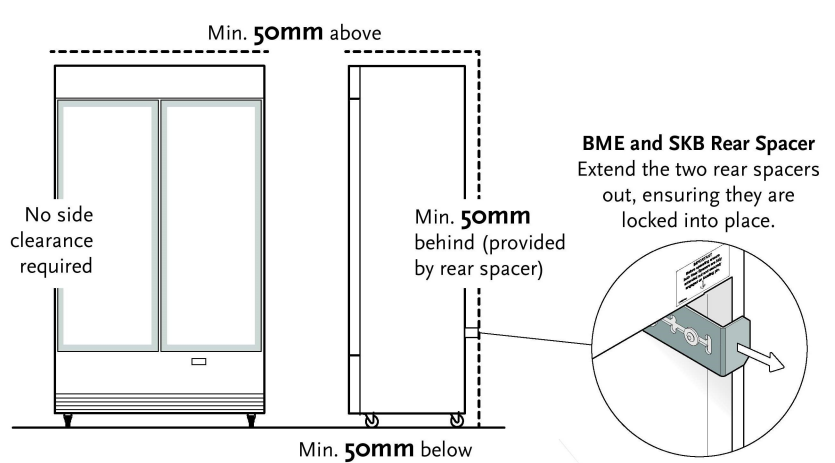

Door Handles

The door handles may be packed inside the fridge.

To fit door handle

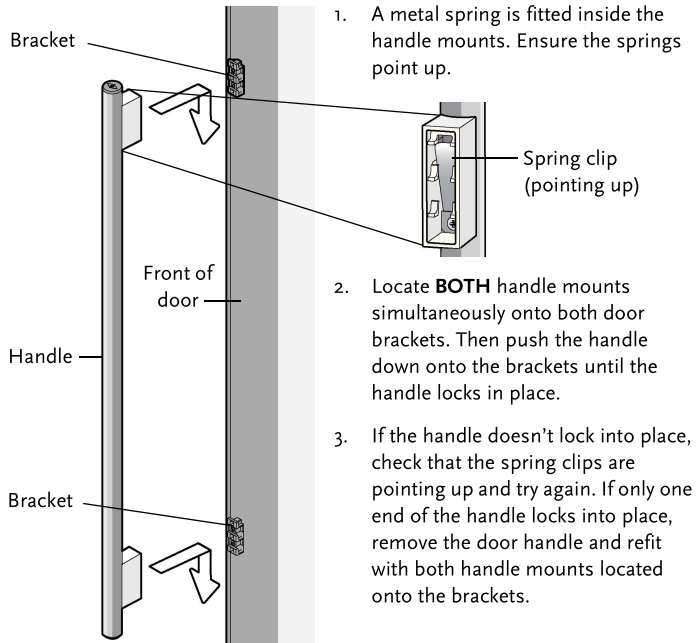

To remove door handle

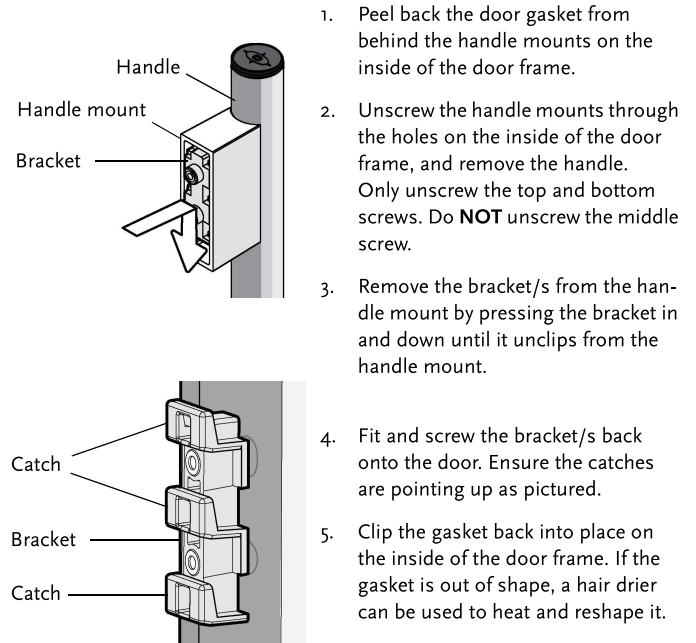

Shelves

The wire shelves sit on shelf clips. The shelf clips twist onto the shelf support strips in the cabinet interior. The shelves may be positioned at different heights to suit various product. Use the numbers on the shelf support strips to assist with setting the shelf clips at the same height.

BME and SKB fridges are fitted with solid bottom shelves, which must remain in place at all times.

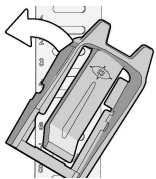

To fit a shelf clip:

Twist anticlockwise onto the shelf support strip.

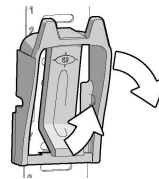

To remove a shelf clip:

Pull the centre tab up and twist off clockwise.

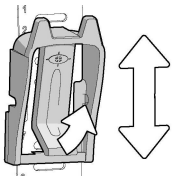

To adjust the shelf clip height:

Pull the centre tab up and slide up or down as required. Once in position, ensure it clicks into place.

Loading product

Let the fridge run for 30 minutes before loading it with product for the first time. When loading the shelves with product:



Max. Loading
Do not overload the shelves



Shelf Flexing
Remove product if the shelf is flexing



Shelf Overhang
Do not let product overhang the shelves

Door Lock/s

The fridge may be fitted with bracket locks or key locks, located above or below each door. Bracket locks require a lock (padlock or similar) through the brackets to lock the door. Key locks can be locked with the supplied key.

Electronic Controller

The electronic controller regulates the fridge's temperature, signals alarms and captures operational information. The fridge temperature is factory set for storage of perishable product (all shelves maintain temperatures below 5°C).

To customise the fridge settings to your requirements and view historical data, download the SKOPE-connect app from the Google Play Store or Apple App Store, and connect via **Bluetooth®**.

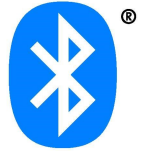

Lights

The fridge lights switch on and off automatically depending on fridge usage.

Cleaning

Ensure the fridge is unplugged from the power supply before cleaning.

Wipe the inside and outside of the cabinet with a damp cloth, taking care to keep moisture away from electrical parts.

The condenser coil must be kept clean. SKOPE strongly urges monthly cleaning of the condenser coil and air filter (optional air filter available on BME only). Do **NOT** use hard or sharp tools to clean the coil as these may cause damage.

TME and SKT - Clean Coil

1. Unplug the fridge from the power supply.

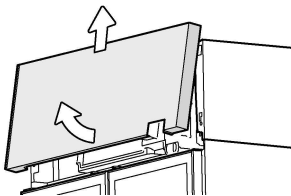

2. Remove the front panel from the top of the cabinet. Lit sign panels also need to be unplugged.

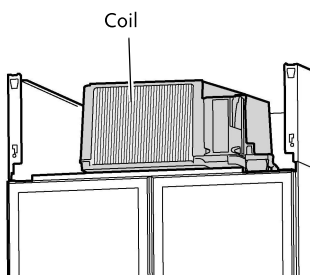

3. Brush the condenser coil with a soft brush to remove any dust and fluff.

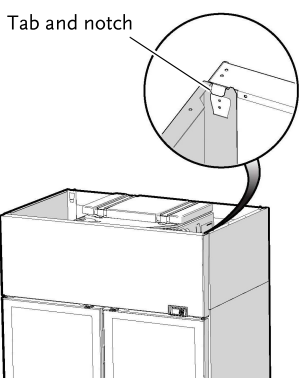

4. Refit the sign assembly and reconnect to the power supply.

Important

When refitting, ensure the tabs on the back of the sign are located in the notches on top of the cabinet, and that the sign is pushed fully in and secure.

BME and SKB - Clean Filter

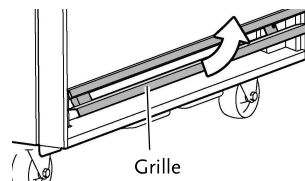

1. Rotate the grille at the bottom of the front kick panel out to gain access to the filter.

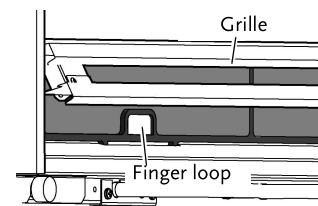

2. To remove the filter, use the finger loops to pull the filter up and detach from the front kick panel.
3. Clean the filter with a vacuum cleaner, wash with cold water and shake excess water off before refitting. Do not apply hot water, blow dry or place in dishwasher. If necessary, discard and refit new air filter.

4. To refit the filter, insert it up into the front kick panel vent with the finger loops facing out. Then clip the into the slots on the bottom face of the front kick panel vent.

BME and SKB - Clean Coil

1. Unplug the fridge from the power supply.
2. Remove the front kick panel from the front of the cabinet.
3. Brush the condenser coil with a soft brush to remove any dust and fluff.
4. Refit the front panel and reconnect to the power supply.

